



OTDR

Optical Time Domain Reflectometer

For T-BERD[®]/MTS-2000, -4000 V2, -5800,

SmartOTDR, CellAdvisor 5G and

OneAdvisor-800 Platforms

User Manual

OTDR

Optical Time Domain Reflectometer For T-BERD[®]/MTS-2000, -4000 V2, -5800, SmartOTDR, CellAdvisor 5G and OneAdvisor-800 Platforms

User Manual



Viavi Solutions
1-844-GO-VIAVI
www.viavisolutions.com

Notice

Every effort was made to ensure that the information in this document was accurate at the time of printing. However, information is subject to change without notice, and VIAVI reserves the right to provide an addendum to this document with information not available at the time that this document was created.

Copyright

© Copyright 2023 VIAVI Solutions Inc. All rights reserved. No part of this guide may be reproduced or transmitted, electronically or otherwise, without written permission of the publisher. VIAVI Solutions and the VIAVI logo are trademarks of VIAVI Solutions Inc. (“Viavi”).

The Bluetooth® word mark and logos are registered trademarks owned by Bluetooth SIG, Inc. and any use of such marks by VIAVI is under license.

All other trademarks and registered trademarks are the property of their respective owners.

Patented as described at www.viavisolutions.com/patents.

Open source disclaimer - IMPORTANT READ CAREFULLY

This product includes third party software licensed under the terms of separate open source software licenses. By using this software you agree to comply with the terms and conditions of the applicable open source software licenses. Software originated by VIAVI is not subject to third party licenses. Terms of the VIAVI Software License different from applicable third party licenses are offered by VIAVI alone.

Product Regulatory Compliance

California Proposition 65

California Proposition 65, officially known as the Safe Drinking Water and Toxic Enforcement Act of 1986, was enacted in November 1986 with the aim of protecting individuals in the state of California and the state's drinking water and environment from excessive exposure to chemicals known to the state to cause cancer, birth defects or other reproductive harm.

For the VIAVI position statement on the use of Proposition 65 chemicals in VIAVI products, see the Hazardous Substance Control section of [VIAVI's Standards and Policies](#) web page.

EU WEEE and Battery Directives

This product, and the batteries used to power the product, should not be disposed of as unsorted municipal waste and should be collected separately and disposed of according to your national regulations.

VIAVI has established a take-back processes in compliance with the EU Waste Electrical and Electronic Equipment (WEEE) Directive, 2012/19/EU, and the EU Battery Directive, 2006/66/EC.

Instructions for returning waste equipment and batteries to JDSU can be found in the WEEE section of [VIAVI's Standards and Policies](#) web page.

If you have questions concerning disposal of your equipment or batteries, contact VIAVI's WEEE Program Management team at WEEE.EMEA@VIAVISolutions.com.

EU REACH

Article 33 of EU REACH regulation (EC) No 1907/2006 requires article suppliers to provide information if a listed Substances of Very High Concern (SVHC) is present in an article above a certain threshold.

For information on the presence of REACH SVHCs in VIAVI products, see the **Hazardous Substance Control** section of [VIAVI's Standards and Policies](#) web page.

EU CE Marking Directives (LV, EMC, RoHS, RE)

This product conforms with all applicable CE marking directives. Please see EU Declaration of Conformity for details.



Contents

About This Guide	xiii
Purpose and scope	xiv
Assumptions	xiv
Technical assistance	xiv
Recycling Information	xiv
Conventions	xiv
Chapter 1 Starting up	1
Unpacking the device - Precautions	2
Precautions relating to the OTDR Module use	2
Connecting fiber optic cable	2
Inspecting and cleaning connector end faces	2
Optical connector types	3
Connecting Fiber optic cable to test port	4
Optical connectors and interchangeable adapters	5
Interchangeable adapters	5
Cleaning universal connectors	6
Chapter 2 SMART TEST function	7
Principle of the Smart TEST	8
Selecting Smart TEST	8

- Configuring the unit for Smart TEST 9
 - Selecting the configuration file..... 9
 - Modifying some parameters before the acquisition 10
- Performing acquisitions in Smart TEST mode 12
 - Performing acquisition in Real Time 12
 - Stopping the real time acquisition 14
 - Performing an acquisition in Smart TEST mode 14
 - Actions on trace during acquisition 15
- Results display..... 17
 - SmartLink view 17
 - Showing the detailed information of one event 19
 - Grouped events 19
 - Trace View..... 21
 - Display of events on the trace..... 22
 - Results table 22
 - Cursors 24
 - Zoom function 25
 - Grouped events 26
 - Table View..... 26
 - Changing the type of an event 27
- Saving results for Smart TEST acquisitions 28

Chapter 3 Expert OTDR function 31

- Principle of the Expert OTDR..... 32
- Selecting Expert OTDR..... 32
- Configuring the unit for Expert OTDR 33
 - Configuring the Acquisition parameters..... 33
 - Specific Acquisition parameters with DWDM Modules..... 37
 - Configuring the Alarms parameters 39

Configuring the Display parameters	41
Section Attenuation	42
Section Length	42
Index of refraction	42
Scatter coefficient	44
Distance Unit	44
Results on trace	44
Show cursors	44
Configuring the Advanced parameters	44
Front Connector Meas	45
Detection	45
Configuring the Link Description parameters	46
Fiber Id	47
Fiber Number	47
Change Fiber Nbr	47
Cable Id	48
Direction	48
Location A	48
Location B	48
Configuring the Project Information parameters	48
Technician Id	49
Job Id	49
Comment	49
Configuring the Report parameters	49
File(s) save in	50
Dir	50
Filenamng	50
File Content	51
Auto Store	51
Report As	52
Report Layout	52
Report naming	52
Include Microscope Image	52
Configuration in Test Auto mode	53
Saving OTDR configuration in a file	54

- Loading an existing OTDR configuration 55
- Performing acquisitions in Expert OTDR mode 56
 - Performing acquisition in Real Time 56
 - Stopping the real time acquisition 57
 - Performing an acquisition with Expert OTDR 58
 - Multi-wavelength acquisition 59
 - Actions on trace during acquisition 59
- Results display 61
 - SmartLink view 61
 - Trace View 61
 - Table View 62
 - Changing the type of an event 63
- Advanced functions 64
 - Automatic measurement and detection 64
 - Addition of events 64
 - Representation of the events 64
 - Hints on the positioning of markers 65
 - Deleting events 65
 - Manual measurements 65
 - Measurements of slope 65
 - Measurement of ORL 67
 - Measurement of Reflectance 67
 - Splice measurements 68
 - Memorization of the position of events 70
 - Overlay trace function 70
 - Overlaying several traces stored in memory 71
 - Display of traces in overlay 71
 - Adding traces in overlay 72
 - Removing a trace 72
 - Reference Trace function 73
 - Use of the reference trace function in the Result page 73
 - Using the reference trace function in the explorer 74
- Saving the trace(s) and generating a report 75
 - Saving results and creating a report from results page 75

Opening a report	77
Chapter 4 File management	79
Description of the explorer	80
Opening the file explorer.....	80
Managing tabs	80
File signature.....	81
Buttons on the right of the screen	81
Storage media.....	81
Directories and files editing function.....	81
Saving and loading files	82
Saving files from the Explorer	82
Loading files and displaying traces.....	83
Simple loading.....	83
Load with configuration	83
Loading several traces in overlay.....	84
Exporting files	84
Explorer/Link Manager.....	84
Editing function	86
Exporting a directory in a txt file	86
Generating pdf report(s)	87
Using the Merge key, with the txt/pdf files	88
Chapter 5 Technical specifications	91
OTDR modules technical specifications.....	92
Characteristics of reflectometry measurements	92
Manual Measurement	93
Typical specifications	93
Ranges	97
Class of the lasers of the OTDR modules.....	99
OTDR modules measurement.....	100
OTDR Module supply	100

Environment..... 100

- Indoor/outdoor 100
- Temperature 100
- Humidity 101
- Pollution degree 101

OTDR Technical specifications for SmartOTDR 101

- OTDR Optical Interfaces 101
- OTDR Optical characteristics 101
- Characteristics of reflectometry measurements..... 102
- Typical specifications 104
- Characteristics of the Source (standard) and Power Meter (optional)
105
 - Source..... 105
 - Power meter (through OTDR port) 105
 - PON/XG-PON Power Meter (E118FA65PPM version) 105

Chapter 6 Options and accessories 107

Commercial References of measurement modules for T-BERD/MTS-
2000/4000 V2 108

- OTDR Modules..... 108
- CWDM OTDR Modules..... 109
- DWDM OTDR Modules 109
- Options 110

Commercial References of the SmartOTDR..... 110

Index 113



About This Guide

The VIAVI equipments provide handheld, modular platforms designed for the construction, validation and maintenance of fiber networks.

The topics discussed in this chapter are as follows:

- [“Purpose and scope” on page xiv](#)
- [“Assumptions” on page xiv](#)
- [“Technical assistance” on page xiv](#)
- [“Recycling Information” on page xiv](#)
- [“Conventions” on page xiv](#)

Purpose and scope

The purpose of this guide is to help you successfully use the equipment features and capabilities. This guide includes task-based instructions that describe how to configure, use, and troubleshoot the equipment with OTDR module.

Assumptions

We are assuming that you have basic computer and mouse/track ball experience and are familiar with basic telecommunication and fiber optic concepts and terminology.

Technical assistance

If you require technical assistance, call 1-844-GO-VIAVI. For the latest TAC information, go to <http://www.viavisolutions.com/en/services-and-support/support/technical-assistance>.

Recycling Information

VIAVI recommends that customers dispose of their instruments and peripherals in an environmentally sound manner. Potential methods include reuse of parts or whole products and recycling of products components, and/or materials.

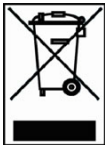

Waste Electrical and electronic Equipment (WEEE) Directive

In the European Union, this label indicates that this product should not be disposed of with household waste. It should be deposited at an appropriate facility to enable recovery and recycling.

Conventions

This guide uses naming conventions and symbols, as described in the following tables.

Table 1 Typographical conventions

Description	Example
User interface actions appear in this typeface .	On the Status bar, click Start .
Buttons or switches that you press on a unit appear in this TYPEFACE .	Press the ON switch
Code and output messages appear in this <code>typeface</code> .	All results okay
Text you must type exactly as shown appears in this <code>typeface</code> .	Type: a:\set.exe in the dialog box
Variables appear in this typeface .	Type the new hostname .
Book references appear in this typeface .	Refer to <i>Newton's Telecom Dictionary</i>
A vertical bar means "or": only one option can appear in a single command.	platform [a b e]
Square brackets [] indicate an optional argument.	login [platform name]
Slanted brackets < > group required arguments.	<password>

Table 2 Keyboard and menu conventions

Description	Example
A plus sign + indicates simultaneous keystrokes.	Press Ctrl+s
A comma indicates consecutive key strokes.	Press Alt+f,s
A slanted bracket indicates choosing a submenu from menu.	On the menu bar, click Start > Program Files .

Table 3 Symbol conventions



This symbol represents a general hazard.



This symbol represents a risk of electrical shock.



NOTE

This symbol represents a Note indicating related information or tip.



This symbol, located on the equipment or its packaging indicates that the equipment must not be disposed of in a land-fill site or as municipal waste, and should be disposed of according to your national regulations.

Table 4 Safety definitions



WARNING

Indicates a potentially hazardous situation which, if not avoided, could result in death or serious injury.



CAUTION

Indicates a potentially hazardous situation which, if not avoided, may result in minor or moderate injury.

Starting up

This chapter describes how to start using the equipment.

The topics discussed in this chapter are as follows:

- [“Unpacking the device - Precautions” on page 2](#)
- [“Precautions relating to the OTDR Module use” on page 2](#)
- [“Connecting fiber optic cable” on page 2](#)
- [“Optical connectors and interchangeable adapters” on page 5](#)

Unpacking the device - Precautions

We suggest that you keep the original packing material. It is designed for reuse (unless it is damaged during shipping). Using the original packing material ensures that the device is properly protected during shipping.

If another packaging is used (for returning the equipment for example), VIAVI cannot give warranty on good protection of the equipment.

If needed, you can obtain appropriate packing materials by contacting VIAVI Technical Assistance Center.

Precautions relating to the OTDR Module use

If the equipment is used in a manner not specified by the manufacturer, the protection provided by the equipment may be compromised.

Contact authorized, trained and qualified service personnel for all services.

Fans on OTDR Modules

Take care fans may be present on the side of the OTDR product. Under normal operation, no injury may occur to the user

Connecting fiber optic cable

Inspecting and cleaning connector end faces



Always inspect and clean the connector end face of the optical fiber cable and the test port before mating both together.

VIAVI is not responsible for damage and reduced performance caused by bad fiber handling and cleaning.

- Optical connector contamination is the #1 source of performance degradation and test equipment repair

- A single particle mated into the core of a fiber can cause significant back reflection, insertion loss and equipment damage. Visual inspection is the only way to determine if the fiber connectors are truly clean before mating them.

Follow this simple "INSPECT BEFORE YOU CONNECT" process to ensure fiber end faces are clean prior to mating connectors

Figure 1 "Inspect Before You Connect" process

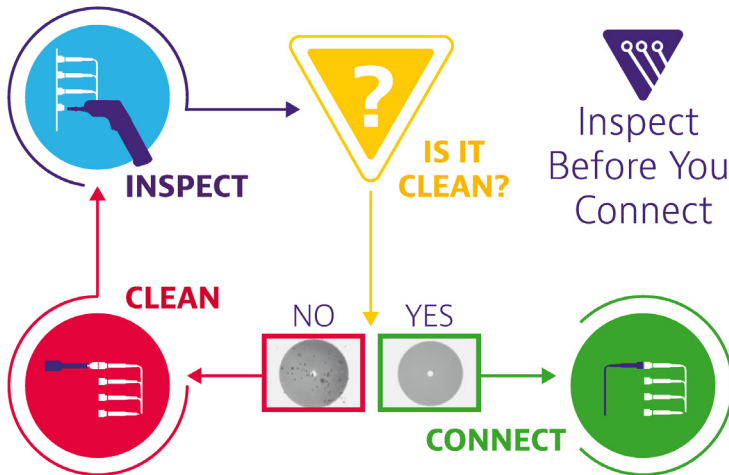

Optical connector types

There are many optical connectors in the market place. Always ensure to use a high quality connector that meets the international standards.

Two main types of connectors are deployed in the telecommunication industry:

- 1 Straight polished connectors, so called PC or UPC
- 2 Angled polished connectors, so called APC

The PC or UPC-type test port is identified by a grey cap with the addition of a "PC" label. The APC-type test port is identified by a green cap with the addition of a "APC" label.

Figure 2 Modules with APC and PC connector

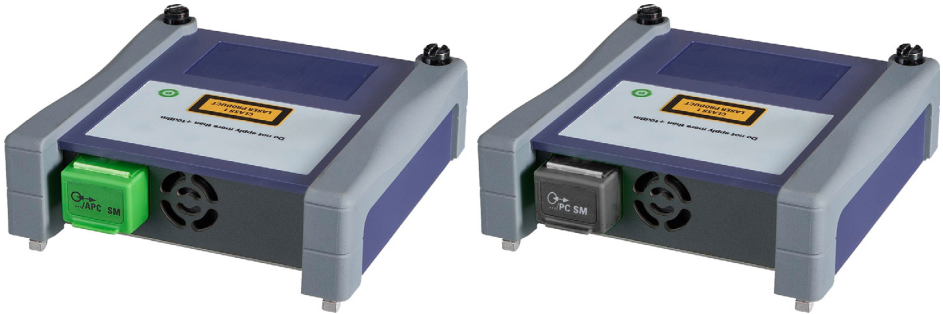

Caution

Never connect a PC connector into an APC test port or vice versa. This will result in damaging the connector end faces.

Figure 3 PC/APC bad connection

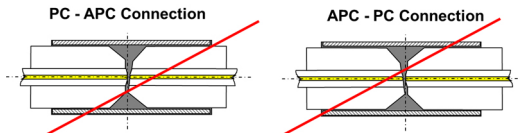

WARNING

VIAVI declines responsibilities of connector damages if a poor quality connector is used or APC to PC connections made. Test port connector repair will be charged

Connecting Fiber optic cable to test port

After ensuring proper cleaning of both end connectors, follow the below steps in order to correctly and safely connect the optical fiber into the test port:

- 1 Carefully align the connector and test port to prevent the fiber end from touching the outside of the port and scratching the end face.



NOTE

If your connector features a keying mechanism, ensure that it is correctly fitted into the test port's insert.

- 2 Push the connector to firmly place it inside ensuring physical end face contact.



NOTE

If your connector features a screw-on sleeve, tighten the connector to firmly maintain the fiber in place. Do not over tighten as this will damage the fiber and the test port.



WARNING

Never force the connector ferrule or insert it with an angle into the test port adapter. Mechanical stress may permanently damage the ceramic sleeve of the adapter or the end face of the connector. A new adapter purchase only will get the unit back to operation

Optical connectors and interchangeable adapters

Fiber Optic modules will come with a UPC or APC connector.

Interchangeable adapters

VIAVI offers interchangeable adapters, allowing the user to switch from one adapter to another according to which fiber type he intends to work with. Adapter types supplied are: FC, SC, LC and ST.

In order to switch from an adapter to another, proceed as follow:

- 1 Unscrew the VIAVI screwdriver to find the 3 different tips for the adapters and set the correct one on the screwdriver.
- 2 Unscrew the current adapter using the VIAVI screwdriver with the correct tip.
- 3 Pull the adapter to remove it.

- 4 Set the new adapter and use the VIAVI screwdriver with the correct tip to screw it.

Figure 4 Removing and refitting an adapter



Cleaning universal connectors

Remove the adapter in order to access the ferrule and clean it using a cotton swab.

SMART TEST function

This chapter describes the entire Smart Test function, and all the processes available with this function.

The topics discussed in this chapter are as follows:

- "Principle of the Smart TEST" page 8
- "Selecting Smart TEST" page 8
- "Configuring the unit for Smart TEST" page 9
- "Performing acquisitions in Smart TEST mode" page 12
- "Results display" page 17
- "Saving results for Smart TEST acquisitions" page 28

Principle of the Smart TEST

The Smart TEST is used to perform OTDR acquisitions using a pre-loaded configuration file (no setup required) and access to essential analysis features.

Smart TEST standard process

- 1 Select the configuration file, which contains all acquisition parameters and file storage setup, and which has been created in Expert mode (see ["Saving OTDR configuration in a file" on page 54](#)).
- 2 Configure / modify some parameters before starting the test.
- 3 Start the acquisition (standard or real time)
- 4 Save the results

Figure 5 Standard Smart TEST Process

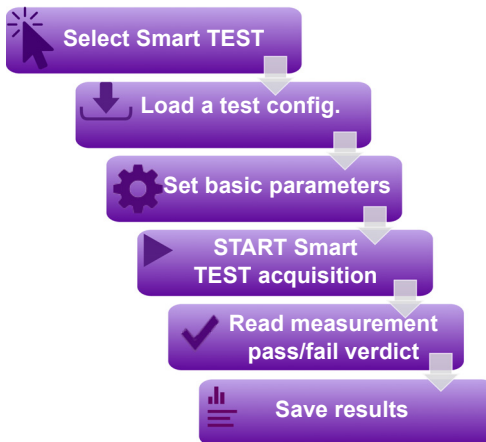

Selecting Smart TEST

The Smart TEST function is available for any OTDR module installed on the equipment. To select this function, after the equipment starts:

- 1 Press the **HOME** button
- 2 Select the Smart TEST icon.

The icon turns yellow



The screen for configuration file selection is automatically displayed.



NOTE

The selection of Smart TEST icon automatically deselects the **Expert OTDR** icon and vice-versa.



NOTE

In case of Singlemode/Multimode module, there are distinct icons: one for multimode with a "MM" indicator and another one for singlemode with no specific indicator..

Configuring the unit for Smart TEST

Selecting the configuration file

To load the configuration file to be used for Smart TEST:

- 1 If necessary, click on the button  to display a higher level of the directory disk/config.
- 2 In the selection file screen, select the configuration file to be used for the acquisition on Smart Test mode.
The file is highlighted in purple.
- 3 Press **Load** to load the selected file and display the current parameters for this configuration.

Figure 6 Load file as Smart TEST Configuration



4 Once loaded, the configuration parameters that can be modified displays.

Modifying some parameters before the acquisition

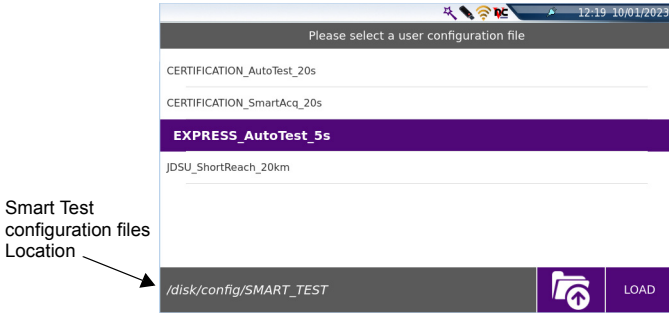
In Smart TEST mode, the user has access to 4 parameters which can modified before launching the test.

Figure 7 Smart TEST Setup page

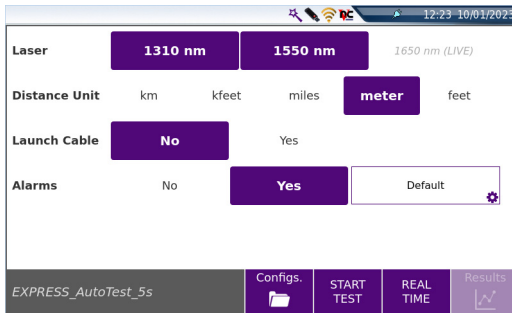



- **Laser** The acquisition will be carried out on the selected wavelength(s). The wavelengths depend on the module type (e.g. DWDM wavelengths available on 4100 DWDM OTDR Modules).
- **Distance unit** select the unit to be used for distance (**km / kfeet / miles / meter / feet / inch**).

- **Launch cable** Define if the Launch Cable must be taken into account for the acquisition: **No / Yes**.

If **Yes** is selected, set the length clicking on text box and:

- enter the distance using the numeric keypad.

or

- Click on  to perform a measurement of the launch cable: a dialog box informing to connect the launch cable displays. Press  once it is connected to start the measurement.



Launch cable measurement in progress...



Once the measurement is completed, the distance is automatically entered in the numeric keypad and the keypad is closed.

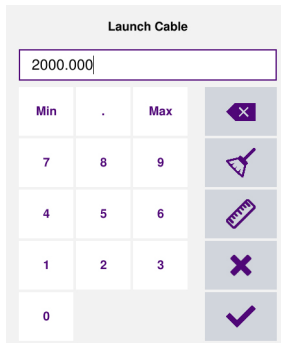

Launch Cable

2000.000

Min	.	Max	
7	8	9	
4	5	6	
1	2	3	
0			

- **Alarms** Define if alarms thresholds must be applied to the acquisition: Select **No** if no alarm thresholds. Select **Yes** to define alarms, and tap in the box to list the available alarms. Select the desired one.

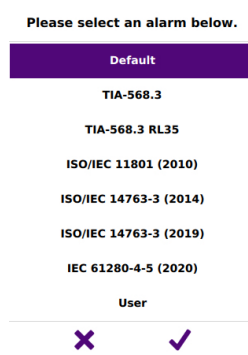

See tables [page 40](#) to get the values for each pre-defined alarm thresholds.

The **User** thresholds can be modified only in Expert mode and saved in a new configuration file.

Once all configuration parameters are correctly defined, the acquisition can be launched.

Press **Config** key to return to the configuration selection screen (see [Figure 7 on page 10](#)).

Performing acquisitions in Smart TEST mode

The acquisition is carried out with the parameters saved in the Configuration file. It may be stopped at any time using the **Start** key.

At the end of test, the results page displays.

Performing acquisition in Real Time

To carry out an acquisition in real time:

- 1 In the **Setup** page of the Smart Test mode, press **Real Time** key  (see [Figure 7 on page 10](#)).

or

If the results page is displayed, when an acquisition in Smart TEST has already been performed, press **Real Time** menu key .

The red **Testing** indicator will go on to show that real time acquisition is in progress. The trace acquired is displayed in real time.

An indicator of the state of the connection (**Good/Bad**) is displayed below the trace:

Table 1 Connection indicator

State	Connection
Good	The connection is OK
Bad	<ul style="list-style-type: none"> There are several connectors close to the external connector of the equipment One of the connectors is dirty or badly connected. Replace the launch cable, make the connection again properly or clean the connector of the OTDR or of the jumper. No fiber is connected.

If the state of the connection is bad, it is still possible to carry out a measurement, but the results will not be very reliable.

Figure 8 Example of acquisition in Real Time

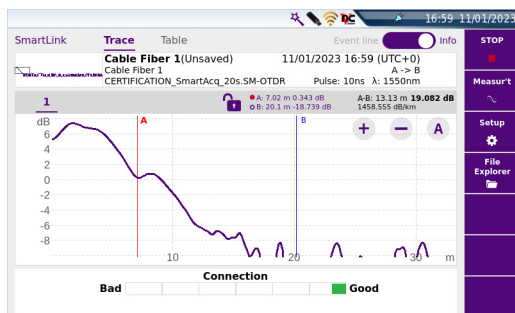

Traffic detection

Traffic on the fiber under test is automatically detected and reported.

Press the **START** key to begin the measurement. A message indicates there is traffic on the fiber and asks you if you wish to continue or not:

- If you click on **No**, the measurement is not launched.
- If you click on **Yes**, the measurement is performed, despite the traffic.



NOTE

If the measurement is validated despite the traffic (key **Yes**), the next measurement will be automatically performed, even if traffic is still detected on fiber.

If the measurement is canceled (key **No**), and the **Start** pushed another time, the box asking if you wish to continue or not is displayed.

The functioning of Traffic Detection is then indicated in the scaled down representation of trace, on the upper left part of screen: **LFD** is flashing.



During an acquisition in real time, several actions can be made on results in progress: see "[Actions on trace during acquisition](#)" page 15.

Once results is

Stopping the real time acquisition

To stop or interrupt an acquisition in real time mode, press the **Start** key at any time.

Performing an acquisition in Smart TEST mode

- 1 From the **Setup** page, press **Start Test** key  to launch measurement (see [Figure 7 on page 10](#)).

The red **Testing** indicator goes on to show that the T-BERD/MTS is in process of acquisition and the screen displays the trace in process of acquisition.

- 2 The quality of the connection is displayed for a few seconds (see [Table 1 on page 13](#))



- 3 Then, a bar graph shows elapsed and remaining acquisition time.

Figure 9 Acquisition in progress in Smart TEST

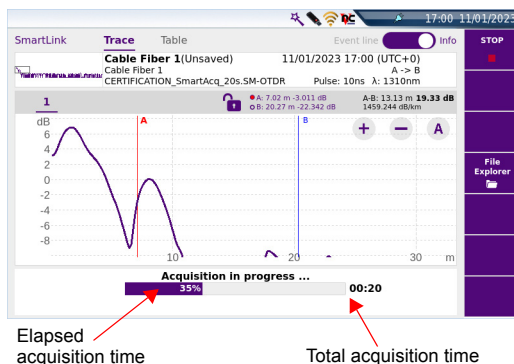

At the end of the acquisition, a beep is emitted, and the measurements are displayed, in SmartLink view, with a dialog box indicating the pass or fail verdict.



NOTE

During acquisition, the traffic on fiber is automatically detected (see "Traffic detection" page 13)

Actions on trace during acquisition

During an acquisition, several actions are available on results in progress.

Modifying acquisition parameters (Real Time mode only)

You can modify the acquisition parameters during the acquisition:

- 1 Press the **Setup** key.
- 2 Scroll through the possible values of the parameters.

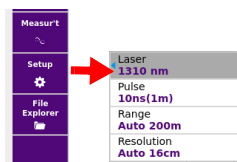

Performing measurements during acquisition (Real Time mode only)

The real time mode allows to make Loss, ORL or Reflectance measurement using the A & B cursors and the key **Average**:





- 1 Position A & B cursors on the trace
- 2 Click on **Measur't** 
- 3 Define the measurement wished (Loss, ORL or Reflectance) in the **Test** scrolling menu and get the result between A & B cursors.

Figure 10 Example of loss measurement

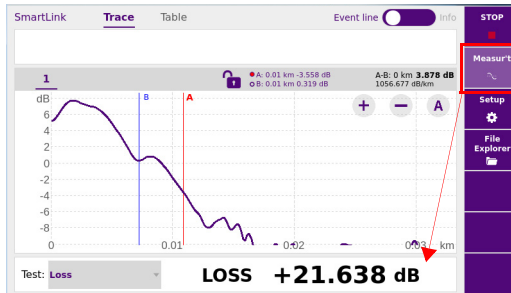

Actions on Display

- Positioning Cursors A and B
Click on the Cursor line on the trace to select the cursor, and click on the trace:
 - Set both cursors A & B to control distance between two points.
 - Set one cursor A or B to get the distance from one point.
 - Set one cursor A or B to zoom on this cursor
- Zooming on trace
Click on the key  or  to zoom in or out on the trace.
Click on the key  to get an automatic zoom on trace during acquisition.
See “Zoom function” on page 25)

- Shifting the trace
The trace can be shifted vertically or horizontally during the acquisition: Click on the trace and move upward/downward or toward left or right (see “ Shift function” on page 25)
- Displaying Trace or SmartLink page
Click on **Trace** or **SmartLink** to display either:
 - the acquisition trace in progress and the bar graph of time
 - the Smart Link page with exclusively the bar graph of time.
 In the case of measurement on several wavelengths, once a measurement is completed for one wavelength:
 - the **Trace** function allows to display the trace and results table for this wavelength.
 - the **Smart Link** function allows to display a graphical view of results for this wavelength.

Results display

The traces acquired or recalled from a memory are displayed on the Results page.

SmartLink view

Once the results trace is displayed, click on **SmartLink** key to display the Smart Link view.



NOTE

The SmartLink view is displayed by default after an acquisition.

At the end of the acquisition, a pop up window displays the overall test results. Tap this window to close it.

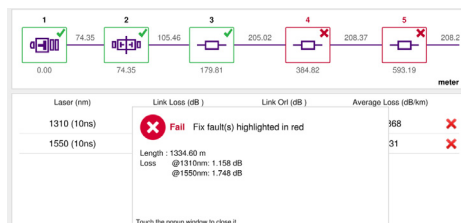

Once the pup window is closed, a screen as the following one is displayed:

Figure 11 SmartLink function

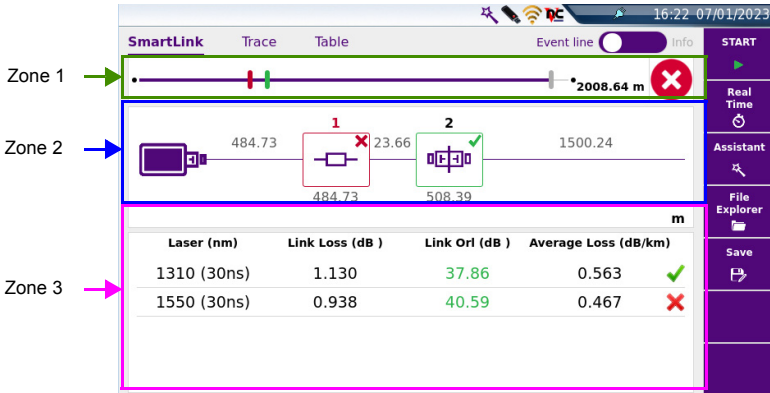

The screen is divided into three zones:

- Zone1:** the **Event line**, which is a graphical representation of the fiber with the detected events position on this fiber and the alarm status icon, or the **Info** bar, with the acquisition parameters of the trace, together with a small-scale representation of the trace.

Click on the button to switch from **Event line** to **Info** and vice-versa.

Figure 12 Event line or Info bar

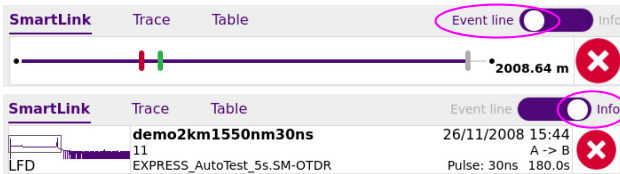

NOTE

This zone is available whatever is the display: SmartLink, Trace or Table.

- **Zone 2:** Graphical representation of the link, with icons symbolizing the different events detected.
- **Zone 3:** Link Table, which gives a summary of results for each wavelength, with results within/without thresholds in green/red (according to Alarm thresholds defined in the setup screen).

Showing the detailed information of one event

The information concerning the event, its type and the alarm thresholds defined for this event, can be displayed from the SmartLink screen.

- 1 Select the event for which information must be displayed, on the graphic.

The event is highlighted in purple once selected.



A frame displays, and describes:

- the event type
- the value above which it is on defect

Figure 13 Event Details

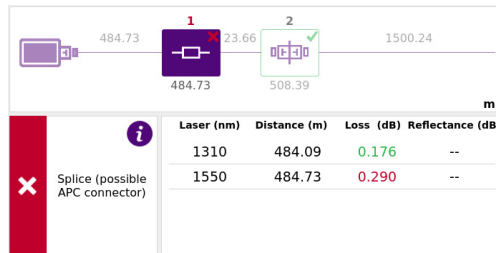

NOTE

The event is displayed with a red icon if it is above the alarm thresholds defined in the setup menu.

A green icon is displayed if it lies within the thresholds.

A yellow icon is displayed if the value is above a «Warning» threshold.

No icon is displayed if no alarm has been defined in the Setup menu

Grouped events

If two events are very close to each other, they are grouped with a square on the graphic.

Either the group of events can be selected, or only one event of this group.

Group selection

To select a group of events, click on space between the events (not on the link section):

- The total loss of the group is displayed for each wavelength
- The reflectance displays the worst reflectance of the group

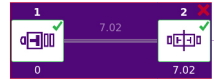
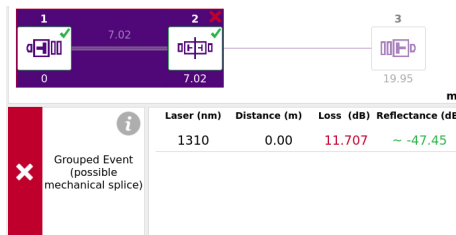

Figure 14 Grouped events



Sub Event selection

Click on one event icon to select this icon from the group.

- The loss of the selected event is not displayed in this case
- The reflectance displays the estimated reflectance value for the selected event

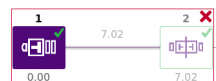
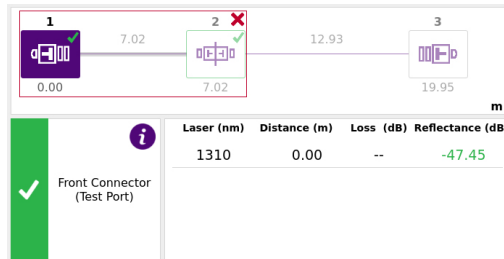

Figure 15 Grouped events - one event selected



Trace View

To display the trace and results table, click on **Trace**.

Figure 16 Example of results trace with Smart TEST

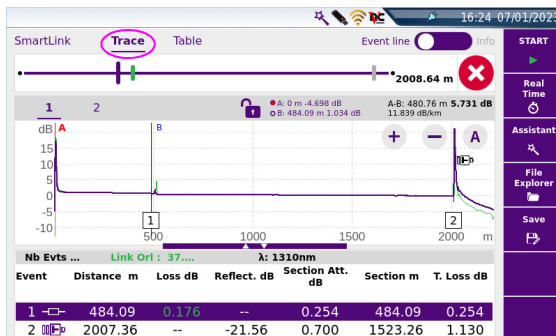

Click on **Assistant** softkey to return to Setup Information page.

Table 2 Alarms display



Fail

Indicates that at least one result exceeds the alarm thresholds defined in the configuration file used for acquisition
Results are displayed in red in table.

Table 2 Alarms display

 Valid	Indicates that all the results lie within the thresholds (no result in red/yellow) Results are displayed in green in the table.
---	--

Display of events on the trace

Each event detected is referenced under the trace by a serial number. The reflectometry trace is displayed with a dotted vertical line set on the start of launch cable  (if the **Launch Cable End** parameter is defined in the **SETUP** menu)

The trace can also be displayed with a dotted vertical line on the end of fiber .

The icon  is displayed on trace if the **Receive Cable Start** parameter has been defined in the Setup menu.

The results of the measurements of attenuation, reflectance and slope can be marked on the trace.

The reflectance of a ghost event is displayed in brackets on the trace.

Criteria for display of an event

An event will be displayed if its attenuation or its reflectance exceeds the corresponding threshold selected in the **SETUP** menu (see "[Configuring the unit for Smart TEST](#)" page 9). Attenuation and reflectance results for an event will be displayed if they can be calculated

The reflectance of an event is always measured except when the event causes a saturated Fresnel peak or if it is drowned out by noise. In this case, the T-BERD/MTS displays > to show that the actual reflectance exceeds the value displayed.

Results table

Under the trace is displayed the results table with all the events detected during acquisition.

The line corresponding to the event nearest to the cursor is highlighted in purple. This highlighting moves if the cursor is moved.

To reduce or enlarge the size of the results table, click and maintain the bar between trace and table and move downward or upward .

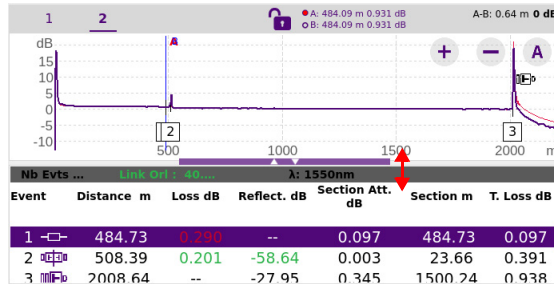

At the top of the table, a line shows the generic parameters of the fiber: numbers of events present, total ORL of the link and the wavelength of the active trace in case of multi wavelengths acquisitions.

Each event is referenced under the trace by a number which is repeated in the first column of the table. The table then shows:

- icon symbolizing the type of the event:

 Receive cable Start

 Launch cable End: the attenuation and distances are measured on the basis of the corresponding marker.

 Non-reflective attenuation (e.g. splice).

 Splitter

 Mux/Demux

 Reflective event. (e.g. connector)

 Ghost reflection

 Slope of the fiber (when no fault follows the slope).

 End of fiber

 OTDR connector

 Bend

 Bend on OTDR Connector

The event underlined in purple is the one the nearest of the cursor set on trace. To visualize an event, click on this event on the table to set the cursor on it onto the trace.

The following columns are then displayed next to each event icon:

Distance	The distance of the event from the beginning of the fiber, in meters (or miles)
Loss	The attenuation due to the event, in dB
Reflect.	The reflectance of the event, in dB
Slope	The slope before the event, in dB/km (or dB/kft) if it can be measured
Section Att.	The attenuation, in dB, between the marker of the event and the previous marker.
T. Loss	The total attenuation of the fiber (total loss), in dB

Cursors

The cursors A and B are represented by vertical lines of different colors:

- The A cursor line is displayed in red.
- The B cursor line is displayed in blue.

The Cursor position is displayed just above the trace: the active cursor is represented with a red/blue point in the cursor bar.

- 1 Touch the screen on the required location on trace where the active cursor must be set.

Above the trace is shown the 2-points loss measurement between the two cursors, together with the distance between the two cursors.

Figure 17 Cursors information

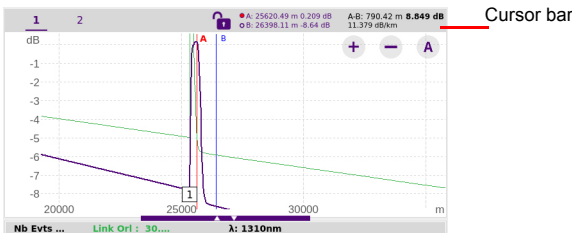

Click on the **Lock** icon in order to select both cursors and move it at the same time on the trace, keeping the current space between them:

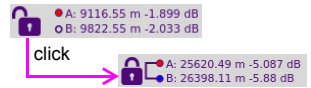

Zoom function

The Zoom function is used to analyze part of the trace in greater detail.

The zoom is centered on the active cursor.

The position of the section of trace displayed with respect to the complete trace is represented by a rectangle on the mini-trace at the top left-hand corner of the screen, if the **Info** bar is selected.



Click as many times as necessary on the Zoom key **+** or **-** to zoom in or out on the trace.

Click on the **Automatic Zoom** key **A** to swap from an automatic zoom to full trace and vice-versa

Specific functions of the zoom with a touchscreen

With the touchscreen:

- maintain your finger pressed on screen and shift the traces horizontally or vertically
- position your finger on a cursor and move it on trace maintaining your finger pressed and moving it toward left or right
- once a zoom is performed, double click on the zoomed zone to undo the zoom

Zooming on the different events in succession

- 1 Set the cursor on one event
- 2 Define a zoom on this event.
- 3 Click on another event in the results table.

The cursor is automatically positioned on this event, which is always centered on the screen, keeping the zoom level selected.

Shift function

The Shift function is used to displace the displayed section of the trace by directly clicking on the touchscreen.

The horizontal shift is performed maintaining the point of intersection between the trace and the selected cursor at the same level, scrolling the trace horizontally while following it vertically, so that it never goes off the screen.

To use this function:

- 1 Click on the trace and displace trace manually on touchscreen toward left/right or upward/backward.

Grouped events

If two events are very close to each other, they are grouped (see "Grouped events" page 19 to get a description of the SmartLink view with grouped events).

In Trace view:

- 1 In the table, the loss of the group will be displayed at 0.0dB.
- 2 The reflectance of the group will display the worst reflectance of the events in the group.
- 3 No loss is displayed on the event level in the group.
- 4 Estimated event reflectance will be displayed for every event in the group.

Figure 18 Trace results - Grouped events

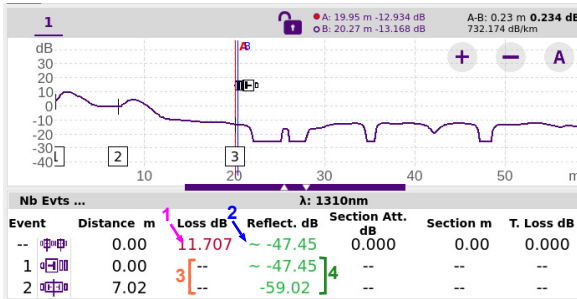

Table View

From the results screen, click on **Table** to display exclusively the measurement results in a table.

Figure 19 Table View

	Distance (m)	Loss (dB)	Reflectance (dB)	Length (m)	Slope (dB/km)	
1	484.73	0.176	--	23.66	--	0.003
2	508.39	--	--	1500.24	0.700	0.345
					0.347	0.231
3	2008.64	--	--			
					-21.56	-27.95

The list of all the events detected during acquisition or manually measured are displayed in a table:

- The events exceeding alarm thresholds are displayed in red, whereas those lying within the thresholds are displayed in green.

Select **Failed** on the button **All** **Failed** to display exclusively the results exceeding the thresholds.

Changing the type of an event

The type of event can be modified, either from **Trace**, **SmartLink** or **Table** view:

- Maintain pressed the icon to be modified, in the results table.
- In **SmartLink** or **Table** view, in the menu open, select the new type of event to be applied.

In Trace view; click first on **Event Codes**, and select the new type of event to be applied.

Figure 20 Event Code

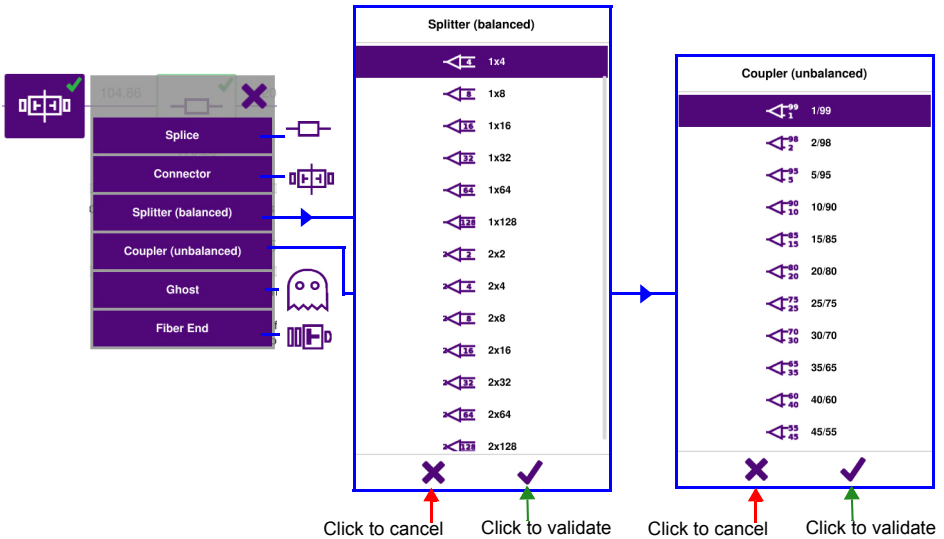

Click on **the cross** to cancel the modification.



NOTE

The event modification is automatically applied on trace and in the results table.

Saving results for Smart TEST acquisitions

Once the acquisition is completed, the results trace displays, in Smart Link view, with the **Save** key displayed.

- 1 Click on **Save** key  to save the results in a file.

The Recording Information page displays

Figure 21 Save results in Smart TEST mode

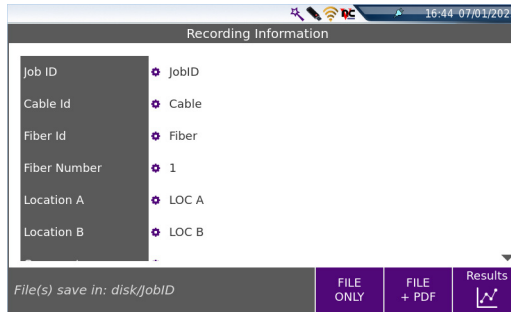



- 2 Click on one parameter configuration (white background) to modify it using the edition or numeric keyboard displayed:
 - **Job Id**: click on the Job description currently defined to display the edition keyboard and enter a new description.
 - **Cable Id**: click on the cable name currently defined to display the edition keyboard and enter a new cable name.
 - **Fiber Id**: click on the fiber name currently defined to display the edition keyboard and enter a new fiber name.
 - **Fiber Number**: click on the fiber number currently defined to display the numeric keyboard and enter a new fiber number.
 - **Location A / Location B**: click on the location name currently defined to display the edition keyboard and enter a new name.
 - **Comment**: click on the comment text box to enter a comment for the file.



NOTE

The file is saved automatically by default in a folder with the **Job Id** parameter.

Example: if the **Job Id** is defined with *Test Fiber 1*, the folder is named *Test Fiber 1*.

- 3** Once the recording information are defined as wished, select the saving mode wished:
- Click on **FILE ONLY**  to save exclusively the results trace to the .sor format
 - Click on **FILE + PDF**  to save the results trace in a .sor file and to generate a pdf report of the results.
 - Click on **Results**  to return to Smart Test result view.

Expert OTDR function

This chapter describes the different stages in performing an acquisition in Expert OTDR mode, from configuration to results saving.

The topics discussed in this chapter are as follows:

- ["Principle of the Expert OTDR" page 32](#)
- ["Selecting Expert OTDR" page 32](#)
- ["Configuring the unit for Expert OTDR" page 33](#)
- ["Performing acquisitions in Expert OTDR mode" page 56](#)
- ["Results display" page 61](#)
- ["Advanced functions" page 64](#)
- ["Saving the trace\(s\) and generating a report" page 75](#)

Principle of the Expert OTDR

The Expert OTDR is used to

- perform OTDR acquisitions with full OTDR setup capabilities, and advanced analysis features.
- create configuration files that can be loaded by SmartTEST users.

Selecting Expert OTDR

The Expert OTDR function is available whatever is the OTDR module set onto the equipment.

To select this function, after the equipment start:

- 1 Press the **HOME** button
- 2 Select the Expert OTDR icon 

The icon turns yellow , then the result page displays.



NOTE

The selection of Expert OTDR icon automatically deselects the SmartTEST icon and vice-versa.



NOTE

In case of Singlemode/Multimode module, there are distinct icons: one for multimode with a "MM" indicator and another one for singlemode with no specific indicator.

- 3 Press the **Setup** menu key on the Results page.

The sub-menus allows the selection of:

- Acquisition parameters
- Alarms parameters
- Display parameters
- Advanced parameters

} Used for the OTDR acquisition

- Link Description parameters
 - Project Information parameters
 - File parameters
- } Used for the OTDR results saving

Configuring the unit for Expert OTDR

Configuring the Acquisition parameters

You can choose the OTDR acquisition parameters.

- 1 Once the **Setup** menu is opened, press **Acquisition** to configure the Acquisition parameters.

Figure 22 Acquisition parameters

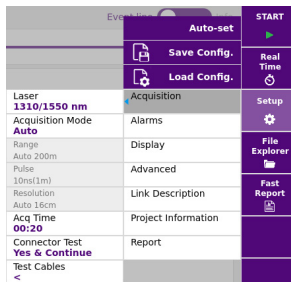

Laser

The acquisition will be carried out on the wavelength(s) selected (for multiple-wavelength modules). In case of a multi-wavelength module, select **All** to perform a measurement for all the wavelengths available (this parameter is only available for modules with a single OTDR port). The wavelengths available to select depend on the module type.

Acquisition Mode

Select the type of acquisition to be performed:

- Manual** The acquisition parameters **Pulse** / **Range** / **Resolution** can be set by the user.

Auto The acquisition parameters **Pulse / Range / Resolution** are defined automatically and cannot be modified.

The **Measurement time** will be set to **Auto**, but can be modified (see "[Acq. Time](#)" page 35).

Smart Acq (not available in Multimode) SmartAcq is a fully automated acquisition process which uses different pulse widths for a single wavelength to maximize the detection. The multiple acquisitions are combined to form a single graph and table of events per wavelength, combining the most relevant sections of each pulse.

Range

The possible range depends on the pulse length selected. This range is given for each pulse length in the paragraph "[Ranges](#)" on page 97. This parameter is only configurable if **Acquisition** parameter is set to **Manual**.

Auto allows to detect automatically the range. The range is selected as a function of the detection of the end of the fiber.

Pulse

Parameter selectable only if **Acquisition** parameter is set to **Manual**. The range of selectable pulse widths varies by module type and will have values in the range 3ns to 20us.

In the case of a multi wavelength acquisition:

- you can define a pulse for each wavelength:
 - a** select each wavelength in the **Laser** parameter and define a pulse
 - b** Once all lasers are configured, go back to the pulse line and select **Multi**.
- you can define a pulse for all lasers:
 - c** select **All** on the **Laser** parameter
 - d** select a pulse, which will be common to all lasers

See "[Typical specifications](#)" page 93.

To manually enter a pulse width value:

- 1** Select one **Laser** only,
- 2** Select the **Pulse** parameter to display **Manual** in the list.

- 3 Click on this parameter **Manual** and enter the pulse value in the numeric keypad. Press  to validate.

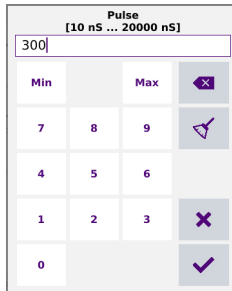

Pulse			
[10 nS ... 20000 nS]			
300			
Min		Max	X
7	8	9	↶
4	5	6	
1	2	3	X
0			✓



NOTE

Changing the **Pulse** parameter may automatically change the **Range** parameter and vice versa.

Resolution

This parameter is only configurable if **Acquisition** parameter is set to **Manual**.

Auto resolution is selected automatically according to the last two parameters above.

High Resolution the highest resolution is applied

High Dynamic the lowest resolution is applied to get the highest dynamic range.

Acq. Time

Real time the equipment performs up to ten acquisitions per second (see [“Performing acquisition in Real Time” on page 40](#)).



NOTE

Whatever the acquisition mode selected, an acquisition in real time mode can be launched by pressing the **Real Time** softkey and/or long-pressing the **START/STOP** button pressed for about 2 seconds.



NOTE

If the **Acquisition** parameter is set to **Auto**, then the **Time** parameter is set to **Auto**, but can be modified.

- Manual** Enter the acquisition time desired (from 5 s. to 5 minutes max).
- Predefined** Select one of the acquisition times predefined: 10 seconds / 20 seconds / 30 seconds / 45 seconds / 1 minute / 90 seconds / 2 minutes / 3 minutes.

Otdr Connector test

This parameter allows to choose if a test of the front connector must be performed when acquisition is launched.

- No** the OTDR connection is tested with indication Bad/Good.
- Yes & Continue** the OTDR connection is tested, and if the state is bad, the acquisition continues but a warning displays.
- Yes & Abort** the OTDR connection is tested, and if the state is bad, a warning displays and the acquisition stops.

Test cable

Launch Cable / Receive Cable

- No** All the results are displayed and referenced relative to the connector on the module.
- Evt 1, 2, 3** The results relating to the launch cable are eliminated from the table. Attenuation and distances are then measured on the basis of the marker Evt 1, 2 or 3 as selected.
- Length** Press the **Length** selection a second time to display a keyboard. Enter the desired length value or measure the cable length using the  key.

Figure 23 Launch Cable / Receive Cable



Include Link Start Connector / Include Link End Connector

Defining the **Launch Cable End** parameter with an event number or a distance will automatically activate the corresponding parameter **Include Link Start Connector**. This parameter can be set to **Yes** if the budget/overall loss must include the launch cable end connector loss.

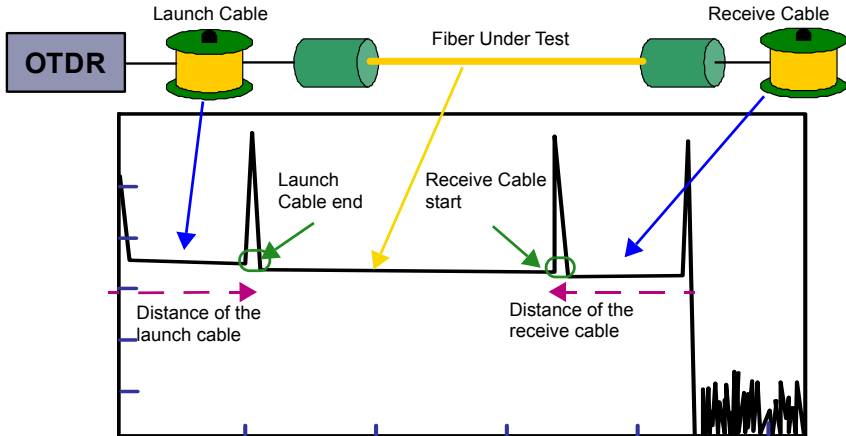
Defining the **Receive Cable Start** parameter with an event number or a distance, will automatically activate the corresponding parameter **Include Link End Connector**. This parameter can be set to **Yes** if the budget/overall loss must include the receive cable start connector loss.

If those parameters are set to **No**, the budget /overall link loss does not include these connectors in the calculation.

Specific Acquisition parameters with DWDM Modules

If a DWDM Module is installed onto the Platform, the **Setup > Acquisition** screen allows the configuration of specific parameters for acquisition on DWDM networks:

Figure 24 Acquisition parameters with DWDM module

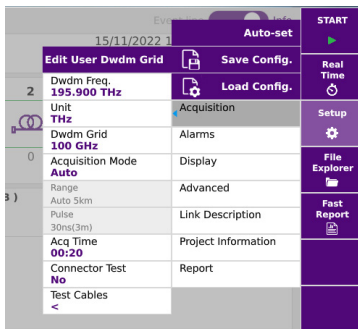

Wavelength

The acquisition will be carried out on the wavelength selected. Once a wavelength is selected, the Channel is indicated just before to the wavelength.

Click on **Prev.** or **Next.** to display the 10 previous / following wavelengths.

Unit

Define the wavelength unit to be used for acquisition: **THz**, **nm** or **Channel**.

Dwdm Grid

Select one of the pre-defined Grid to be used for acquisition: **25 GHZ / 50 GHZ / 75 GHZ / 100 GHz / 200 Even / 200 Odd / Wavescan**.

Or

Select **User** and press the **Edit User Dwdm Grid** menu key to define a grid.

Defining a grid

- 1 Once the menu key **Edit User Dwdm Grid** is pressed, a table displays.

Figure 25 User-defined grid

	Channel	Select all		Unselect all	
		Frequency (THz)	Wavel. (nm)	Selected	
084	H20	192.050	1561.01	No	
085	C20	192.000	1561.42	No	
086	H19	191.950	1561.83	No	
087	C19	191.900	1562.23	No	
088	H18	191.850	1562.64	No	
089	C18	191.800	1563.05	No	
090	H17	191.750	1563.45	No	

- To configure your own grid, click on one channel (highlighted) to switch from **Yes** to **No** and vice-versa.
or
Click on **Select all** or **Unselect all** to select all channels of the table, or to unselect the selected ones.
- Once configuration of the grid is completed, press **X** to return to Setup screen. Changes to the table will be saved automatically.

Configuring the Alarms parameters

In the **Setup** menu, press **Alarms**.

Once the **Alarms** menu is displayed, configure the thresholds to be applied to the measurement. No need to redo an acquisition to apply them to the current measurement.

Figure 26 Alarms parameters

None	Threshold User	Auto-set	STARI
Default	Splice Loss No	Save Config.	Real Time
TIA-568.3	Connector Loss No	Load Config.	Setup
TIA-568.3 RL35	Reflectance No	Alarms	File Explorer
ISO/IEC 11801 (2010)	Mux/Demux No	Display	Fast Report
ISO/IEC 14763-3 (2014)	Slope	Advanced	
ISO/IEC 14763-3 (2019)	Fiber Length Min. No	Link Description	
IEC 61280-4-5 (2020)	Fiber Length Max. No	Project Information	
User	Link Loss Min. No	Report	
	Link Loss Max. No		
	ORL No		

Alarms Level

None The alarm function is not active.

User define your own thresholds values for one or several elements:
Splice / Connector / Reflectance / Slope / Fiber Length Min and Max
/ Total Loss Min and Max / ORL

TIA-568 3 / TIA-568 3.RL35 / ISO/IEC 11801 2010 / ISO/IEC 14763-3 2014 or 2019 / IEC 61280-4-5 (2020) / Default: Select one of this parameter to configure the alarm thresholds with predefined values:

Table 3 Singlemode Modules

	Splice Loss	Connector loss	Reflectance	Slope	ORL	Mux/Demux
Default	> 0.20 dB	> 0.50 dB	> - 35 dB	> 1.00 dB/km	< 27 dB	No
TIA-568.3	> 0.30 dB	> 0.75 dB	No	> 1.00 dB/km	No	-
TIA-568.3 RL35		> 0.75 dB	> - 35 dB	> 1.00 dB/km		-
ISO/IEC 11801 (2010)		> 0.50 dB	> - 35 dB	> 0.40 dB/km		-
ISO/IEC 14763-3 (2014)		> 0.75 dB	No	> 0.40 dB/km		-
ISO/IEC 14763-3 (2019)		> 0.75 dB	> - 35 dB	> 0.40 dB/km		-
IEC 61280-4-5 (2020)		> 0.75 dB	> - 35 dB	> 0.40 dB/km		-

Table 4 Multimode Modules

	Splice Loss	Connector loss	Slope 850 nm	Slope 1300 nm	Reflectance	ORL
Default	> 0.20 dB	> 0.50 dB	> 3.50 dB/km	> 1.50 dB/km	> - 35 dB	< 27 dB
TIA-568C ISO/IEC 11801 ISO/IEC 14763-3	> 0.30 dB	>0.50 dB for ISO/IEC 14763-3 standard			-	-

Warning This menu lists possible minor alarm thresholds which the user could select. If results are between those thresholds and the «fail» thresholds, they will be displayed in yellow in the table of results

Thresholds can be set for: Splice Loss / Connector Loss / Reflectance.

If results are above those thresholds:

- they are highlighted in red in the table of results
- the icon  appears at the top right of the screen
- in SmartLink view, the event is framed in red with a red icon

If all the results lie within the thresholds (no result is in red or yellow):

- they are displayed in green in the table
- the icon  is displayed at the right top of the trace.
- in SmartLink view, the event is framed in green with a green icon

If results are very close to the fail thresholds, without exceeding the fail values:

- they will be displayed in yellow in the table of results
- in SmartLink view, the event is framed in yellow with a yellow icon

Configuring the Display parameters

In the **Setup** menu, press **Display**.

Figure 27 Display parameters

	Auto-set	START
	Save Config.	Real Time
	Load Config.	Setup
12.93	Acquisition	File Explorer
Section Attenuation dB/km	Alarms	Fast Report
Section Length Yes	Display	
Index Of Refraction <	Advanced	
Scatter Coefficient <	Link Description	
Distance Unit meter	Project Information	
Results On Trace Graphics	Report	
Show Cursors Yes		

Section Attenuation

- dB/km** Displays the section slope in the table of results. If the fiber is too short to measure the slope accurately, no value is displayed (empty field).
- dB** Displays the section loss in the table of results. With short fiber where the slope cannot be measured with a good accuracy, the loss in dB is approximate and displayed.
- None** The section attenuation and Loss values are not displayed in the table of results.

Section Length

Define if the distance between the marker of the event and the previous marker must be indicated in the results table: select **Yes** or **No**.

Index of refraction

Choice of group refraction index of the whole fiber.

- User** Define for each wavelength (1310 SM, 1360-1510 SM, 1550 SM, 1625 SM) a refraction index of 1.30000 to 1.69999. The selection of an index alters the value of the section AB (actual distance between cursors A and B).
- or,
- If the actual distance between the cursors A and B is known, enter its value under **Section AB** to establish the index of the fiber. Selection of this distance causes the display of the indices. The extreme distance values are given by the index values (1.30000 to 1.70000).
- or
- You can also enter the **Link Length**, if it is known, using the Numeric keypad.
- Predefined** It is possible to choose one of the predefined values given for certain cables. The corresponding indices given in the table below are repeated on the screen.

Figure 28 Predefined index values (Single Mode)

Wavelength (nm)	1310 SM	1360 - 1510 SM	1550 SM	1625 - 1650 SM
Generic G652 G657	1.46750	1.46800	1.46800	1.46850

Figure 28 Predefined index values (Single Mode)

Wavelength (nm)	1310 SM	1360 - 1510 SM	1550 SM	1625 - 1650 SM
Generic G653 G655	1.46750	1.46800	1.46800	1.46850
ATT SM	1.46600	1.46700	1.46700	1.46700
Corning SMF-28	1.46750	1.46810	1.46810	1.46810
Corning SMF-DS	1.47180	1.47110	1.47110	1.47110
Corning SMF-LS	1.47100	1.47000	1.47000	1.47000
Corning-Leaf	1.46890	1.46840	1.46840	1.46900
Draka SMF	1.46750	1.46800	1.46800	1.46850
Draka Longline	1.46700	1.46700	1.46710	1.46750
Draka Teralight	1.46820	1.46820	1.46830	1.46850
Draka Benbright	1.46750	1.46750	1.46800	1.46850
Fitel Furukawa	1.47000	1.47000	1.47000	1.47000
OFS Lucent Allwave	1.46750	1.46750	1.46750	1.46850
Lucent Truewave	1.47100	1.47100	1.47000	1.47000
SpecTran SM	1.46750	1.46810	1.46810	1.46810
Sterlite	1.46700	1.46700	1.46750	1.46750
Sumitomo Litespec	1.46600	1.46600	1.46700	1.47000
Sumitomo Pure	1.46600	1.46600	1.46700	1.47000

Figure 29 Predefined index values (Multi Mode) - Not available in SmartOTDR

Wavelength (nm)	850 MM	1300 MM
Corning 62.5	1.50140	1.49660
Corning 50	1.48970	1.48560
SpecTran 62.5	1.49600	1.49100
Generic 50	1.49000	1.48600
Generic 62.5	1.49000	1.48700
Generic OM1-62/125	1.49600	1.49100
Generic OM2-3- 4 50/125	1.48200	1.47700

Scatter coefficient

In the **Preset Scatter** parameter, define the value for the backscatter to be used in measurements. **Auto** is the recommended setting.

User	Select, for each wavelength, the backscatter coefficient of -99 dB to -50 dB by increments of 0.1dB. Modification of the backscatter coefficient K changes the measurements of reflectance and ORL.
Auto	Backscatter coefficients are selected automatically for each wavelength.

In Multimode, two predefined scatter coefficients are available:

Generic 50	850 MM -> -66.3 dB 1300 MM -> -73.7 dB
Generic 62.5	850 MM -> -66.1 dB 1300 MM -> -70.3 dB

The default values are given in the paragraph "[Reflectance](#)" page 3.

Distance Unit

Define the unit of the distances displayed: km, kfeet, miles, meter, feet.

Results on trace

None	the trace alone
All	the trace with results value (loss, position, reflectance...) and markers.
Graphics	the trace with event markers only.

Show cursors

No	the Cursors A and B are hidged on Trace view
Yes	the Cursors A and B are displayed on Trace view.

Configuring the Advanced parameters

In the **Setup** menu, press **Advanced**.

Figure 30 Advanced parameters

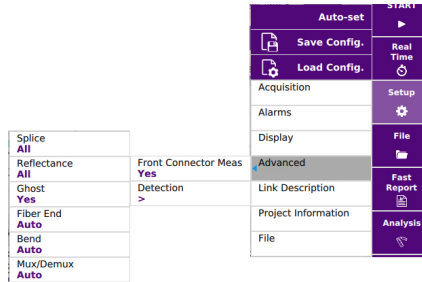

Front Connector Meas

This parameter allows to choose if a measurement of the front connector(s) must be performed.

- No** In the results table, the first line corresponds to the first event of the fiber under test or end of the launch cable.
- Yes** In the results, the first event corresponds to the front connector at 0 meter (loss and reflectance values are estimated).

Detection

Splice

Select if a level of detection for splice must be defined.

Click on the text box and select a value:

- Enter a min level of detection, from 0.01 dB (**Min**) to 1.99 dB (**Max**).
- **No**: no splice detection
- **Auto**: to automatically detect splice

Reflectance

Select if level of detection for reflectance must be defined.

Click on the text box and select a value:

- Enter a min level of detection, from -98 dB (**Min**) to -11 dB (**Max**).
- **None**: no reflectance detection
- **All**: all reflectances are detected (click on  and validate to define **All**).

Ghosts

Choice (**Yes / No / No Analysis**) of whether information relating to ghosts is to be displayed. If ghosts are displayed, the reflection icon in the table of results appears dotted and the reflection value is displayed in brackets on the trace, for example «(R:-50 dB)».

Fiber end

Once parameter is selected, click on the text box to display the numeric keypad and select the required value:

- **Auto** (recommended): option in which the equipment automatically detects the end of a fiber.
- **> 3 (Min) to > 20 dB (Max)** (steps of 1 dB): threshold of detection of end of fiber.

Bend (not available in Multimode)

With any dual or triple-wavelength measurement module, the user will have access to the macro bend detection function in the test setup. Each event of the selected wavelengths will then be compared.

Once parameter is selected, click on the text box to display the numeric keypad and select the wished value:

- **None**: Bend will not be detected.
- **Auto**: Bend will be automatically detected (>0.30 dB).
- **Define by user**: Enter the bend value (in dB), with numeric keypad.

Mux/Demux

Once parameter is selected, click on the text box to display the numeric keypad and select the required value:

- **Auto** (recommended): option in which the equipment automatically detects the mux/demux.
- **> 0.50 (Min) to > 4.99 dB (Max)**: threshold of detection of mux/demux.
- **None**: no mux/demux available.

Configuring the Link Description parameters

In the **Setup** menu, press **Link Description**.

Figure 31 Link Description parameters

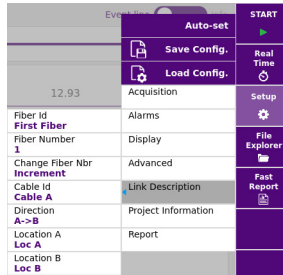

The information entered in the **Link Description** window concerns the editing and/or the modifications of the cable and fiber parameters. When a trace is recalled without recall of the configuration, the parameters of this trace will be present only in its signature.

Link description parameters are recorded in the results files as they are of use for analytics including post processing.

Fiber Id

Select the parameter **Fiber Id** and enter a name for the fiber, using the onscreen keyboard.

Fiber Number

- 1 Select the parameter **Fiber Number** and modify the parameter using the numeric keypad.

The fiber number can be automatically incremented/decremented at each new file save if it has been configured in the File Setup page (see [“Configuring the Report parameters” on page 49](#)).

Change Fiber Nbr

- Increment** the fiber number is automatically incremented at each new file-save.
- Decrement** the fiber number is automatically decremented at each new file-save
- User defined** Use **Edit Number** softkey to enter the increment/decrement value for fiber number.

- Note: to decrement the number, enter the sign «-» before the number.
Example: -1.

Min: -999 / Max: 999 / Auto: 0

No the Fiber number must not automatically modified.

Cable Id

This parameter allows to enter an identification of the cable, using the onscreen keyboard.

Direction

The direction shows if the acquisition has been made from the origin to extremity (A->B) or from the extremity to origin (B->A). Changing direction in the trace simplifies post-processing e.g. for manual bi-directional analysis.

Location A

The name of the Location A of the link may be entered here, using the onscreen keyboard.

Location B

The name of the Location B of the link may be entered here, using the onscreen keyboard.

Configuring the Project Information parameters

In the **Setup** menu, press **Project information**.

Figure 32 Project Information parameters

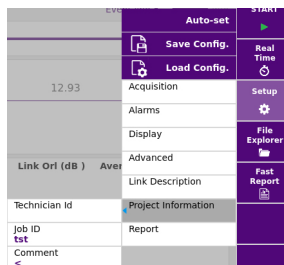



NOTE

Refer to the User Manual of the Cable-SLM option for Project configuration and use.

Technician Id

Click on the text box to enter the name of the operator carrying out the measurement.

Job Id

Click on the text box to enter a description of the measurement to be performed.

Comment

Click on **Comment** text box to enter a specific comment to the project.

Configuring the Report parameters

The Report storage parameters must be also configured, in order to define how and where the results will be saved in the file system of the equipment.

- 1 In the **Setup** menu, press **File**.

Figure 33 File parameters

Event list	Auto-set	START
File(s) save in: disk/(job_id/)	Save Config.	Real Time
Dir disk/tst/	Load Config.	Setup
File naming [Origin_Id]-[End_Id]...	Acquisition	File Explorer
Loc A-Loc B-1310-FiberA0...	Alarms	Fast Report
File Content One Trace	Display	
Auto store No	Advanced	
Report As pdf	Link Description	
Report Layout Standard	Project Information	
Report Naming Loc A-Loc B-1310-FiberA0...	Report	
Include Microscope I... No		

File(s) save in

Click on the text box to display the keyboard and define the directory for files saving

In the onscreen keyboard, select the pre-defined parameters available or, press **abc** key to enter a name manually for the directory. Then, press **Enter** to validate.

Example: disk/OTDR/Test

Figure 34 Directory - Onscreen keyboard

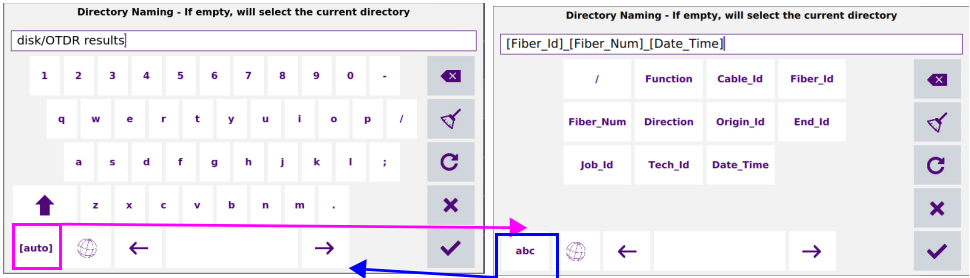

or

Click on **C** or leave the box empty to select the Current Directory for file saving.

Press **✓** to validate.

Press **🌐** to modify the keyboard language: English / French / German.

Dir

This field displays the directory selected/created into which the file(s) will be saved.

Filenaming

Select **Filenaming** parameter and click on the text box to modify the name of the file for the result trace.

Use the onscreen keyboard to view and select the pre-defined parameters available or, press **abc** key to enter a name manually for the file.

Figure 35 Filenaming - Keyboard (auto)

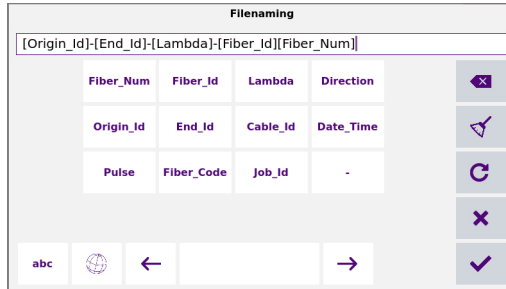

or

Click on  to apply the name by default to the file:

Fiber[Cable_Id]_[Fiber_Num]_[Lambda]_[Direction]

Press  to validate.

Press  to modify the keyboard language: English / French / German.

The name of the file is displayed in grey under **Filenaming** parameter

File Content

In this parameter, select the file content for traces saving:

One Trace in case of traces in overlay, each trace is saved in a distinct file (.sor extension).

All Traces in case of traces in overlay, all traces are saved in one single file (.msor extension).

One and All Traces this option combines the two previous ones: in case of traces in overlay, each trace is saved in a distinct file and all traces are saved in one single file.

Auto Store

Select **Yes** to store automatically the trace or traces resulting from each acquisition according to the filenaming rules. If the filename already exists, the user will be prompted to overwrite the "old" result or discard the current result and keep the "old" file

Select **Confirm if alarm = Fail** to display a confirmation dialog box if a value exceeds alarm thresholds, and to be able to choose to save or not the trace.
If no alarm is detected on trace, it is automatically stored.

Report As

Select the report format to be generated:

- txt file** select **Yes** to generate a txt file of the results.
- pdf file** select **Yes** to generate a report in a pdf file.
- json file** select **Yes** to generate json file(s) compatible with VIAVI test process automation (job manager and StrataSync cloud data management system)..

If all parameters are defined with **No**, only the .sor (or .msor/.csor) file will be saved.

Report Layout

This parameter allows to define the report page setting and is available exclusively if a **pdf** or **txt file** has been defined in the **Report As** parameter.:

- Standard** in multi-traces display, one pdf report page is generated for each trace.
- Consolidated** in multi-traces display, one pdf report page is generated for all traces

Report naming

If **Consolidated** is defined for **Report Layout**, select **Report naming** parameter and click on the text box to modify the name of the report file for the result trace.

Using the onscreen keyboard, enter a name manually for the file and press  to validate.

If no name is entered, the report name by default applies: Report_SM/MM-OTDR.

Include Microscope Image

In the report page, an image of the scope test result can be displayed on the upper part of the report. Select **Yes** to include the scope test result image into the report.



NOTE

This parameter is available only if the report format selected is Pdf.

Configuration in Test Auto mode

The **Auto-set** key imposes the parameters for acquisition, measurement and display of results defined as default settings in factory.

ACQUISITION	Acquisition	Auto
	Acq Time	Auto
	OTDR Connector Test	Yes & Continue
	Launch Cable	No
ALARMS	Alarm Level	None
DISPLAY	Section Attenuation	dB/km
	Section Length	Yes
	Index of Refraction	G652 G657
	Scatter Coefficient	Auto
	Results on trace	Graphics
ADVANCED	Front Connector Meas.	Yes
	Detection Splice	Auto
	Reflectance	All
	Ghost	No
	Fiber End	Auto
	Bend	Auto
	Mux/Demux	Auto
LINK DESCRIPTION	Change Fiber Nr	Increment
REPORT	Filenaming	Auto filenaming
	Cable_Id] [Fiber_Num]_[Lambda] [Direction]	
	Auto Store	Yes

Saving OTDR configuration in a file

Once File and Measurement parameters have been configured, those parameters are kept in memory and can be saved in a configuration file.

This configuration file can then be recalled and reused in two cases:

- in order to be applied when acquisition in SmartTEST mode is performed.
- in order to be recalled for future acquisition in Expert OTDR

To save parameters in a configuration file:

- 1 If necessary, press **Setup** to return to **Setup** menu.
- 2 Select one parameter in one of the setup page (acquisition, link..)
- 3 Press menu key  **Save Config.** .
The onscreen keyboard displays
- 4 Enter a name for the configuration file (max. 20 characters).



NOTE

Configuration file is saved by default in the directory **disk/config**.

Figure 36 Save Configuration file - Onscreen keyboard

Directory into which file will be saved

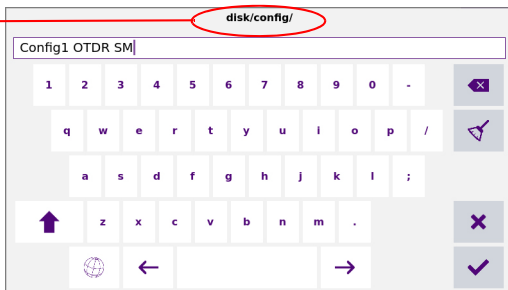

- 5 Press **Enter** to validate

A sound is emitted to indicate the file is saved.

The configuration file is saved with the extension **.fo_cfg** (icon ) and can be recalled at any time from the **File** page.

It can be selected in SmartTEST (see “Selecting the configuration file” on page 9) or loaded for Expert OTDR.

Loading an existing OTDR configuration

To load a configuration file previously created or available in the equipment and apply parameters to new OTDR Expert tests:

- 1 If necessary, press **Setup** to return to **Setup** menu.
- 2 Press menu key  **Load Config.**
- 3 Select the configuration file desired
- 4 Press **Load** > **Load Config.**

You can modify some acquisition or file storage parameters, and save them in a new configuration file (see “Saving OTDR configuration in a file” on page 54).



NOTE

Most of the configuration files are available into the equipment, in `disk/config`.

Figure 37 Loading a configuration file

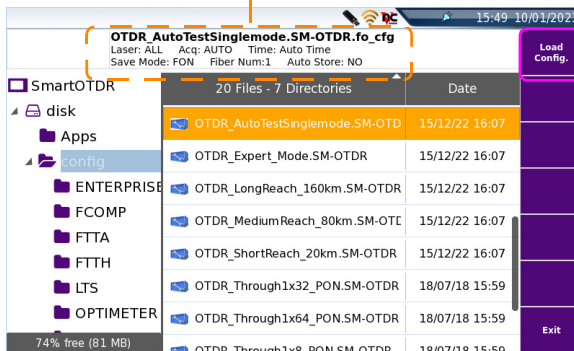

The main parameters available in the selected configuration file are displayed in the File signature.



Performing acquisitions in Expert OTDR mode

Performing acquisition in Real Time

To carry out an acquisition in real time:

- In OTDR Expert results page, press **Real Time** key  or
 Press **Setup** key  and select **Acquisition > Acq. Time** and select **Real Time**, then press **Start** menu key .

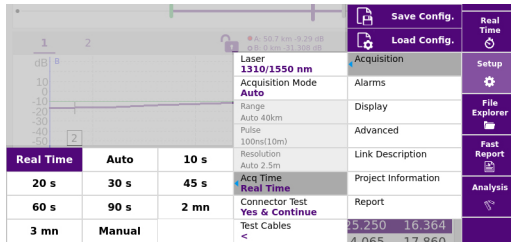

The red **Testing** indicator will go on to show that real time acquisition is in progress. The trace acquired is displayed in real time.

An indicator of the state of the connection (**Good/Bad**) is displayed below the trace:

Table 5 Connection indicator

State	Connection
Good	The connection is OK
Bad	<ul style="list-style-type: none"> There are several connectors close to the external connector of the equipment One of the connectors is dirty or badly connected. Replace the launch cable, make the connection again properly or clean the connector of the OTDR or of the jumper. No fiber is connected.

If the state of the connection is bad, it is still possible to carry out a measurement, but the results will not be very reliable.

Figure 38 Example of acquisition in Real Time

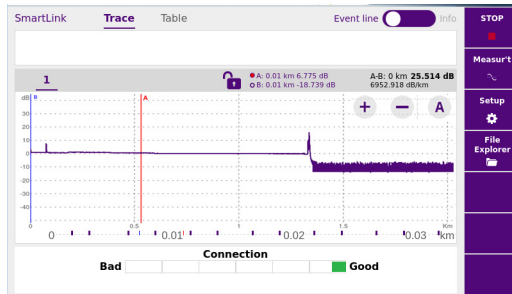

Traffic detection

Traffic on the fiber under test is automatically detected and reported.

Press the **START** key to begin the measurement. A message indicates there is traffic on the fiber and asks you if you wish to continue or not:

- If you click on **No**, the measurement is not launched.
- If you click on **Yes**, the measurement is performed, despite the traffic.



NOTE

If the measurement is validated despite the traffic (key **Yes**), the next measurement is automatically performed, even if traffic is still detected on fiber. If the measurement is canceled (key **No**), and the **Start** pushed another time, the box asking if you wish to continue or not is displayed.

The functioning of Traffic Detection is then indicated in the scaled down representation of trace, on the upper left part of screen: **LFD** is flashing.



During an acquisition in real time, several actions can be made on results in progress: see "[Actions on trace during acquisition](#)" page 59.

Stopping the real time acquisition

To stop or interrupt an acquisition in real time mode, press the **Start** key at any time.

Performing an acquisition with Expert OTDR

In this mode, the equipment carries out a number of averagings defined as a function of the maximum acquisition time specified in the Acquisition menu, and then terminates the acquisition.

The acquisition is carried out with the parameters previously selected in the **Setup > Acquisition** menu. It may be stopped at any time using the **Stop** key.

- 1 Press the **START** key to start the acquisition.
The red indicator goes on to show that the product is in process of acquisition and the screen displays the trace in process of acquisition.
- 2 The quality of the connection is displayed for a few seconds (see [Table 5 on page 56](#))
- 3 Then, a bar graph shows elapsed and remaining acquisition time.



Figure 39 Acquisition in progress with Expert OTDR

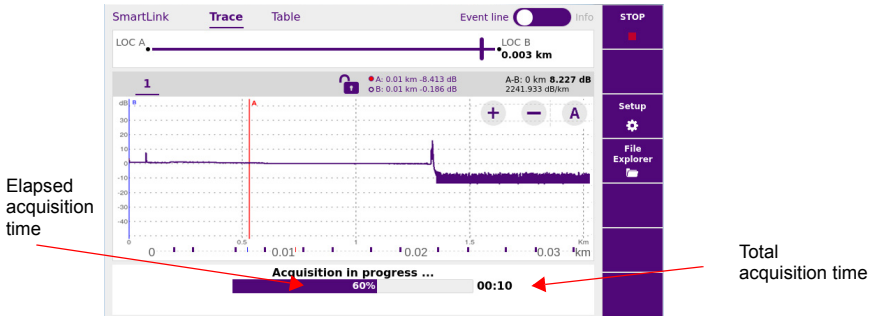

At the end of the acquisition, a beep is emitted, the trace is displayed and an automatic measurement is started.

NOTE
During acquisition, the traffic on fiber is automatically detected (see "[Traffic detection](#)" page 57)

NOTE
To stop the acquisition, the **Stop** key may be pressed at any time. Then an automatic measurement is carried out, but some events can not be detected (a manual measurement must then be made).

Multi-wavelength acquisition

If the module possesses several lasers, to perform successive acquisitions on all the wavelengths:

- 1 In the **SETUP** menu, select **Acquisition > Laser** and ensure that several lasers are selected (or select **All** if a module with only one OTDR port is used).
- 2 Start the acquisition by pressing the **START** button.
- 3 Once the acquisition for the first wavelength is finished, the acquisition for the following wavelength starts automatically.

The different traces appear in the same window and can be handled similarly to overlaid traces (see "[Overlay trace function](#)" [page 70](#)).

Actions on trace during acquisition

During an acquisition, several actions are available on results in progress.

Modifying acquisition parameters (Real Time mode only)

You can modify the acquisition parameters during the acquisition:

- 1 Press the **Setup** key.
- 2 Scroll through the possible values of the parameters.

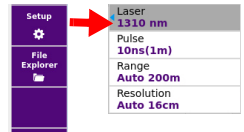

Performing measurements during acquisition (Real Time mode only)

The real time mode allows to make Loss, ORL or Reflectance measurement using the A & B cursors and the key **Average**:

- 1 Position A & B cursors on the trace
- 2 Click on **Measur't** .
- 3 Define the measurement wished (Loss, ORL or Reflectance) in the **Test** scrolling menu and get the result between A & B cursors.

Figure 40 Example of loss measurement



Actions on Display

- Positioning Cursors A and B
Click on the Cursor line on the trace to select the cursor, and click on the trace:
 - Set both cursors A & B to control distance between two points.
 - Set one cursor A or B to get the distance from one point.
 - Set one cursor A or B to zoom on this cursor
- Zooming on trace
Click on the key **+** or **-** to zoom in or out on the trace.
Click on the key **A** to get an automatic zoom on trace during acquisition.
See “Zoom function” on page 25)
- Shifting the trace
The trace can be shifted vertically or horizontally during the acquisition: Click on the trace and move upward/downward or toward left or right (see “Shift function” on page 25)
- Displaying Trace or SmartLink page
Click on **Trace** or **SmartLink** to display either:
 - the acquisition trace in progress and the bar graph of time
 - the Smart Link page with exclusively the bar graph of time.In the case of measurement on several wavelengths, once a measurement is completed for one wavelength:
 - the **Trace** function allows to display the trace and results table for this wavelength.
 - the **Smart Link** function allows to display a graphical view of results for this wavelength.

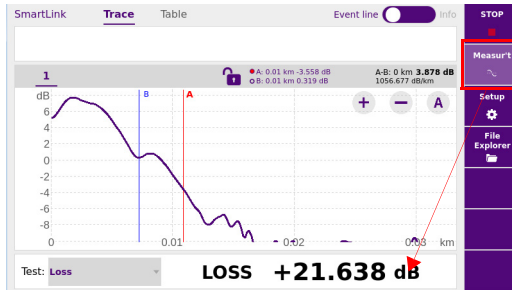
Results display

The traces acquired or recalled from a memory are displayed on the Results page.

SmartLink view

Once the results trace is displayed, click on **SmartLink** key to display the Smart Link view. At the end of the acquisition, a screen as the following one is displayed:

Figure 41 SmartLink function

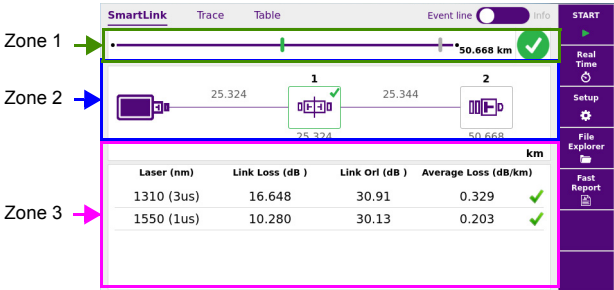

See “SmartLink view” on page 17 to get a full description of the view.

Trace View

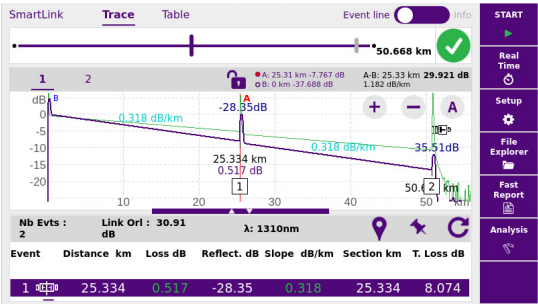

To display the trace and results table, click on **Trace**.

Figure 42 Example of results trace with Expert OTDR



- On the upper right side, the alarm icon is displayed (if some alarm thresholds are defined in the pre-loaded configuration file).

Table 6 Alarms display

 Fail	Indicates that at least one result exceeds the alarm thresholds defined in the configuration file used for acquisition Results are displayed in red in table.
 Valid	Indicates that all the results lie within the thresholds (no result in red/yellow) Results are displayed in green in the table.

See “Trace View” on page 21 to get a full description of the view.

Table View

From the results screen, click on **Table** to display exclusively the measurement results in a table.

Figure 43 Table View

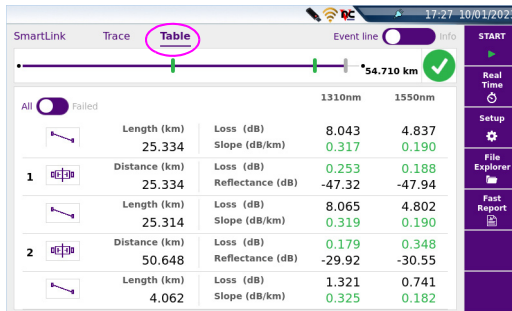

The list of all the events detected during acquisition or manually measured are displayed in a table:

- The events exceeding alarm thresholds are displayed in red, whereas those lying within the thresholds are displayed in green.
Select **Failed** on the button **All**  **Failed** to display exclusively the results exceeding the thresholds.

Changing the type of an event

The type of event can be modified, either from **Trace**, **SmartLink** or **Table** view:

- 1 Maintain pressed the icon to be modified, in the results table.
- 2 In **SmartLink** or **Table** view, in the menu open, select the new type of event to be applied.
In Trace view; click first on **Event Codes**, and select the new type of event to be applied.

Figure 44 Event Code

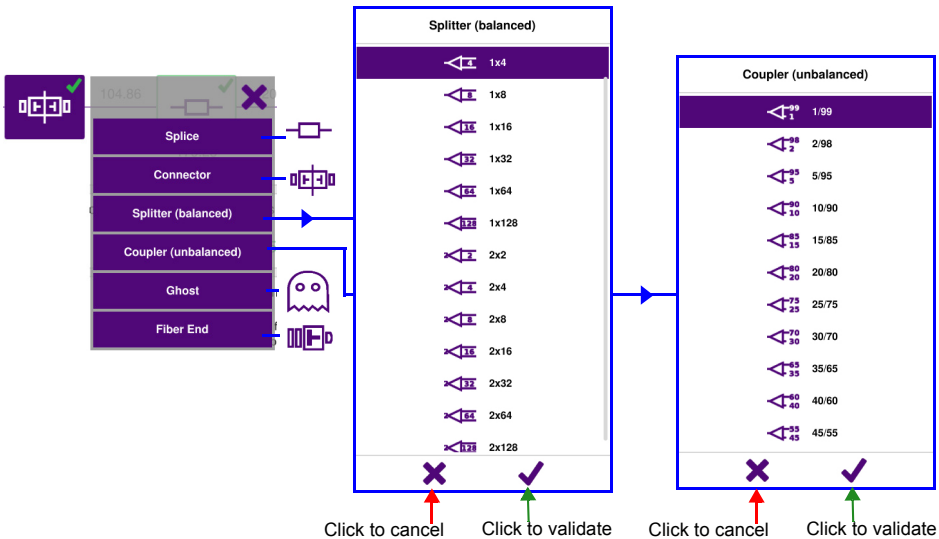

Click on **the cross** to cancel the modification.



NOTE

The event modification is automatically applied on trace and in the results table.

Advanced functions

Several actions on trace displayed can be performed in ExpertOTDR mode.

Automatic measurement and detection

Automatic mode enables rapid detection of all the faults in the trace. The faults detected are then measured and identified on the screen by markers. Only the results exceeding the detection threshold defined in the Setup menu are displayed

By means of this method of detection, you can quickly locate all the faults in the fiber under test. If an automatic measurement does not detect all the events, additional manual measurements can be carried out.

The following procedure is then recommended:

- 1 By default, the instrument locates the events and proceeds to the measurements.
- 2 Addition of events (see [“Addition of events” on page 64](#)) in the cases of splices showing low attenuation and of close events. The T-BERD/MTS then automatically measures the slope before and after the markers selected and measures the attenuation of the splice.
- 3 Addition of manual measurements if necessary (for deeper analysis). The T-BERD/MTS performs the measurements requested by the user.

To carry out an automatic measurement at any time, and get back to the events automatically detected at the end of the acquisition, click on the icon  on the right of the results table.

This action will delete all the events manually added, if any.



Addition of events

You can also manually place markers in addition to those positioned automatically during automatic measurement.

Representation of the events

To add markers of events:

- 1 Select a cursor (A or B).
- 2 Move the cursor to the place where you want to position a marker.

- 3 Press the icon .
- 4 A marker  and an event number are displayed at the position of the cursor and a measurement is carried out on the event.
Measurement of slope before the marker starts just after the previous event (or at the end of the dead zone at the beginning of the fiber); measurement of slope after the marker stops just before the next marker or at the end of the fiber.

Hints on the positioning of markers

- Do not add markers after a manual measurement, as all the results will be recalculated automatically by the instrument.
- If two markers are too close together, they will appear on the trace and the table but no measurement will be carried out on the second marker: to obtain results for this marker, a manual measurement is necessary.
- If you press the key  when the cursor is very close to a marker, the latter will be deleted.

Deleting events

To delete an event, move the cursor onto the event and press the key . The event selected will be deleted and a complete measurement, without this event, is carried out.

Deletion of events can cause incorrect measurement results.

Manual measurements

As soon as you have made an acquisition, with or without automatic measurement, you can make manual measurements on any event on the trace by means of the cursors A and B, in association with the functions of slope, detection of splice and calculation of ORL.

The manual measurements are accessible in the **Results** page, after pressing the keys: **Analysis**.

Measurements of slope

To make a manual measurement of slope, display the trace and press the **RESULTS** button to call up the trace and then:

- 1 Place the cursor A at the beginning of the section of the trace where the slope is to be measured.

- 2 Place the cursor B at the end of this section.
 - 3 Press the **Analysis** key
 - 4 Press **Slope** in the manual measurements bar.
 - 5 Press **Calculate** key.
- The slope of the specified trace section is displayed.

Figure 45 Manual Measurement results

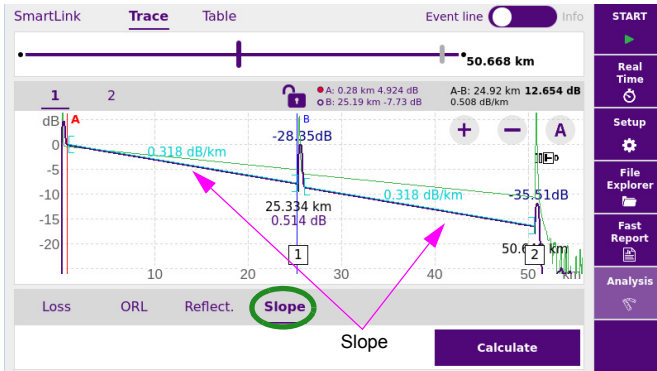

The result is displayed on the screen between the two slope indicators [and].

The measurement results are also available in the table:

Click again on **Analysis** to return to results table display.

"Distance" shows the distance between the beginning of the trace and the end of the slope;

If no result is displayed in the table, this means that the distance between the cursors A and B is too small.

Deleting a slope measurement

To delete a particular slope measurement result:

- 1 Superimpose the cursors A and B on the slope concerned.
 - 2 Click on **Analysis** and click on **Slope** in the manual measurement bar.
 - 3 Press **Calculate** key.
- The slope of the specified trace section is deleted.

Measurement of ORL

It is possible to carry out an ORL measurement on a part of the fiber.

Follow the following procedure to measure a part of the fiber:

- 1 Position the cursors A and B to delimit the section that you wish to measure.
- 2 Press the **Analysis**, then select **ORL** from the manual measurement bar.
- 3 Press **Calculate** key.

The ORL is measured for the section of trace defined.

Figure 46 Result of ORL measurement

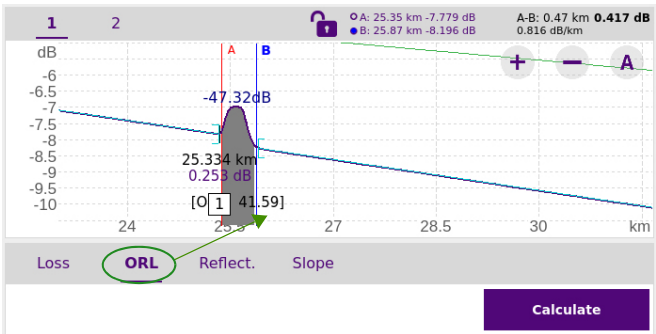

ORL on a saturated trace

If saturation occurs during an ORL measurement, the result is given with the sign <. This means that the actual ORL value is less than the value displayed.

Measurement of Reflectance

It is possible to carry out a reflectance measurement of a Fresnel for a reflective event.

Follow the following procedure to measure the reflectance:

- 1 Position the cursor A at the base of the peak
- 2 Position the cursor B at the top of the peak of the required Fresnel, or after the peak to calculate automatically the maximum reflectance.
- 3 Press the **Analysis**, then click on **Reflect.**
- 4 Press **Calculate** key.

The Reflectance value is defined in dB, and displayed in the trace in purple.

Figure 47 Reflectance measurement

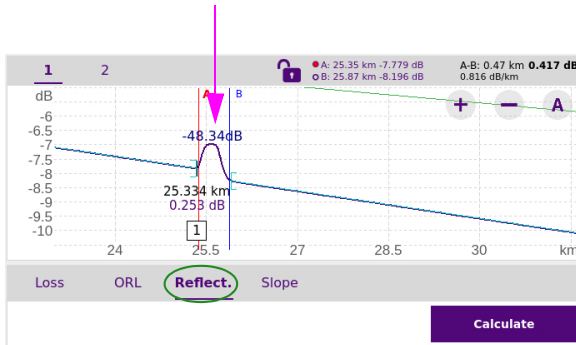

Splice measurements

There are two methods of carrying out manual measurements of splices on the trace: the two-cursor method and the five-cursor method.

The five-cursor method is the more accurate, as it takes into account the difference of level between the slope before the splice and the slope after the splice. This method should be used whenever possible.

If very close events have created a dead zone preventing the measurement of slope by the five-cursor method, it is possible to use the two-cursor method. This considers the difference in level between the cursors.

Before performing one of these measurements, define in the **Setup** menu the splice detection threshold.

Two points method

To perform a splice measurement by the "two-points" method, display the **Results** page, then:

- 1 Place cursor A exactly on the fault, then place cursor B after the splice that you wish to define.
- 2 Press the **Analysis** key, then click on **Loss**.
- 3 Select the function **2 Pt Loss**.

4 Press **Calculate** key.

The splice marker is placed at the point defined by the first (left-hand) cursor and the result is displayed on the screen. If the fault is reflective, the reflectance value is also measured and displayed. These results are added to the table of results.



NOTE

If you try to measure a splice on a slope, the measurement is not carried out and the following error message is displayed: "Slope found between two cursors".

Five points method

To carry out a splice measurement by the "five points" method:

- 1 Measure the slope preceding the fault to be measured, then the slope following it.
- 2 Place the cursor on the fault (between the two sections).
- 3 Press the **Analysis** key, then click on **Loss**.
- 4 Select the function **5 Pt Loss**.
Five cursors (A, a, B, b and C) are displayed on the trace.
- 5 Press **Calculate** key.
The splice event marker is placed on the cursor and the result is displayed on the trace and in the table of results.



NOTE

If no result is displayed, it is possible that the display threshold of the attenuation measurement result is higher than the attenuation that you are trying to measure.



NOTE

If you try to measure a splice on a slope, the measurement is not carried out and the following error message is displayed: Slope found between two cursors.

Memorization of the position of events

Press the icon  to lock markers so all the events measured will be measured on all future traces that are taken.

The positions memorized will then be used in the subsequent measurements, either at the end of the manual acquisition, or when a stored trace is recalled.



NOTE

This function memorizes the markers placed on the current trace.

The following procedure is recommended to start a measurement with markers:

- 1 Carry out an automatic measurement.
- 2 Memorize the position of the events selecting the key .
- 3 Add the manual measurements required (key **Analysis**).

CAUTION

If an event is added (with the key ) after manual measurements have been performed, then all the events on the trace will be converted into AUTO markers and an automatic measurement will be performed using these events. The previous manual measurements will be lost.

Provided the event lock, the automatic measurement following the acquisition is carried out using the events which were present before the acquisition.

If you wish to make a measurement without events, deactivate memorization of events by pressing the key .

Overlay trace function

This very useful function enables up to eight traces to be displayed on the screen at once:

- either to compare traces acquired on a number of different fibers in the same cable,
- or to observe changes over time in traces taken of one and the same fiber.

Figure 48 Example of overlaid traces

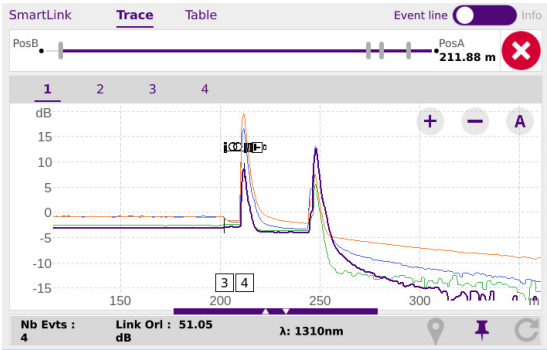

Overlaying several traces stored in memory

To display up to 18 traces from the memory, deleting the current trace(s) already loaded:

- 1 Press the **File** softkey.
- 2 Select the files of the traces for display.
- 3 Press the **Load** key.
- 4 Press **View trace(s)**.
- 5 When loading is complete, the **Results** screen appears: the first trace selected is the active trace (in purple), the other traces being overlaid.

Display of traces in overlay

- The traces are shown in different colors (the active trace is purple).
- Their serial numbers are displayed above the trace view: click on one trace number to activate this trace.
- The OTDR markers are referenced on the active trace by the symbol $\left| \right.$ and the event number, and on the other traces the markers are hidden.
- Measurements can only be made on the active trace and not on overlaid traces. To make measurements on a trace in overlay, it must first be selected, clicking on its corresponding number.

Adding traces in overlay

With one or more traces already displayed, to add further traces to the display (the number of traces displayed cannot exceed 8):

- 1 Define at least one trace as reference (see [“Reference Trace function” on page 73](#))
- 2 Press **File**, and in the Explorer, select the files of the traces to be added.
- 3 Press **Load** key.
- 4 Press the **View Trace(s) or Load Trace + Config.**

When loading is complete, the new traces are displayed in overlay with those that were defined as reference traces (see. [“Reference Trace function” on page 73](#)).

Removing a trace

Removing the current trace in overlay

It is possible to remove a trace displayed. To do this:

- 1 Long click on its number.
A new menu displays.
- 2 Click on **Remove Current Trace**.

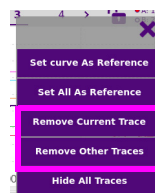

Removing all the traces in overlay

To remove all the traces except the current trace:

- 1 Long click on the number of the trace to keep
A new menu displays.
- 2 Click on **Remove Other Traces**.

Hiding the overlaid traces

To hide all the overlaid traces, except the active trace:

- 1 Long click on one trace number.
A new menu displays.
- 2 Click on **Hide all traces**.
All the overlaid traces are hidden, but are still opened.
- 3 Click on another trace number to display exclusively this trace, and hide all the others.

To show all the traces again, long click on one trace number and click on **Show All Traces**.

Reference Trace function

The reference trace function consists in defining trace(s) which will be «blocked» on screen and used as models before acquiring or loading other standard trace(s).

Use of the reference trace function in the Result page

Once one or several trace(s) is/are displayed, after an acquisition or loaded from the explorer:



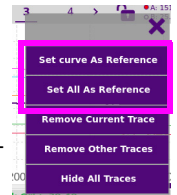

- 1 If several traces are in overlay, check the correct current trace is selected: its number is displayed in purple and underlined.
- 2 Long click on this trace number.
A new menu displays.
- 3 Click on **Set curve As Reference**.
 - The active trace becomes the reference trace: the trace number is displayed with square brackets and with a REF indicator .



To define all the traces displayed as reference traces, click on **Set All As Reference** key (whatever is the active trace).



NOTE

If several traces are defined as reference traces, the color of the REF mark differs for each trace:    .

Removing the reference trace(s)

To change one reference trace into a «standard» trace, select it using the trace number menu, and, after a long click to open the menu, click on **Reset Reference**.

To change all the reference traces displayed into «standard» traces, whatever is the active trace, long click on a trace number and, in the menu, click on **Reset All Reference**.

Performing an acquisition once one or several trace(s) is/are defined

Three situations can occur once an acquisition is performed:

- Only reference trace(s) is/are displayed: the trace acquired is added to the reference ones.
- Reference trace(s) and «standard» trace(s) are displayed: the reference trace(s) are «blocked», the standard ones are removed and the new trace acquired is displayed with the reference one(s).
- No reference trace(s) defined: all the «standard» traces are removed and only the new trace acquired is displayed.

Using the reference trace function in the explorer

A trace stored in memory can be set as reference trace before loading one or several «standard» trace(s).

To open one or several reference trace(s)

- 1 Go on the **File** Explorer clicking on **File** key from the results page.
- 2 Select the trace(s) to be defined as reference
- 3 Click on **Load** and select **Reference = Yes** on the key  .
- 4 Click on **View Trace(s)** or **Load Trace + Config**.
The REF mark appears on the trace number.

To open «standard» traces to be added to the reference ones

- 1 Go back to the Explorer.
- 2 Select the trace(s) to be opened in the same screen as the reference traces
- 3 Click on **Load** and select **Reference = No** on the key  .
- 4 Click on **View Trace(s)** or **Load Trace + Config**.

Saving the trace(s) and generating a report

Once the results page is displayed, the trace(s) can be saved and a report can be generated directly from the results screen, **in Expert Mode only**.

The traces saving and report generation can have already been performed automatically if the parameter **Auto Store** was defined on **Yes** in the Setup screen (see “[Auto Store](#)” on page 51) with the appropriate **Save Mode** (file only or file + txt, + pdf +json).

Saving results and creating a report from results page

To save the trace and generate a report:





- 1 Press **Fast Report** menu key .
A menu displays next to the fast report key.
- 2 In the menu, configure the file saving mode (and the report)

Figure 49 Fast report configuration

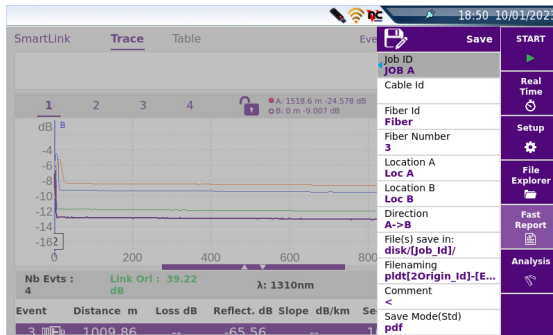

- a If wished, define/modify the name for the Cable, clicking on **Cable Id** and on the text box to display the edition keyboard.
- b Modify the **Fiber Number**.
- c In the **Location A** and **Location B** parameters, enter/modify the name of Origin and Extremity.

- d** In the **Direction** parameter, select/modify the direction, to define if the measurement has been performed from Origin to Extremity (**A -> B**) or from Extremity to Origin (**B -> A**).
- e** If wished, define/modify the name for the Job, clicking on **Job Id** and on the text box to display the edition keyboard.
- f** Click on **Dir. naming** text box and enter the directory path (see "[File\(s\) save in](#)" page 50).
or
In the edition keypad, click on key  to define the current directory as directory for file saving.
- g** Click on **Filenaming** text box and enter a name for the file in the edition keyboard (see [Figure 35 on page 51](#)).
or
In the edition keyboard, click on key  to apply the auto filenaming (see "[Filenaming](#)" page 50)
- h** In the **Save Mode** parameter, select:
 - txt file** select **Yes** to save the results in a .sor file and to generate a txt file of the results.
 - pdf file** select **Yes** to save the results in a .sor file and to generate a report in a pdf file.
 - json file** select **Yes** to generate json file(s) compatible with VIAVI test process automation (job manager and StrataSync cloud data management system)..

If all parameters are defined with **No**, only the .sor (or .msor) file will be saved.
- 3** Once saving is configured as wished, press **Save** key.
- 4** Enter a name for the file in the edition keyboard.
- 5** Press  to validate.



NOTE

The msor file and the txt, pdf and/or json files will have the same name.



NOTE

To modify the directory into which the report will be saved, click on the header of the **Saving** Edition keyboard to display the **Directory** keyboard and enter a new path for the directory.

Once saving is completed, a sound is emitted onto the Platform.

Saving and report for traces in overlay

If several traces are displayed in overlay in the results page, one or several file(s)/report(s) is/are generated:

- If in the File Setup page (**Setup > File**), the parameter **File Content** is defined with **One Trace**, one .sor file and, if the **Format** parameter for txt/pdf file has been defined, one pdf/txt report will be generated for each trace
Example: if 3 traces are displayed in overlay, 3 .sor files (and 3 pdf/txt files) will be saved.
- If in the File Setup page (**Setup > File**), the parameter **File Content** is defined with **All Traces**, one single .msor file and one single txt/pdf report will be generated, bringing together all traces.
Example: if 3 traces are displayed in overlay, one single .msor file and one single txt/pdf file (with one trace per page; except if the results table is too long for one page) will be saved.

Opening a report

- 1 To open the report, press **File** menu key
- 2 In the Explorer page, in the directory selected, select the file/report.
The file name is:
For the txt file: *trace file_sor.txt*
For the pdf file: *trace file.sor.pdf/json*
- 3 Press **Load**.
The file opens on the equipment.

Figure 50 PDF report

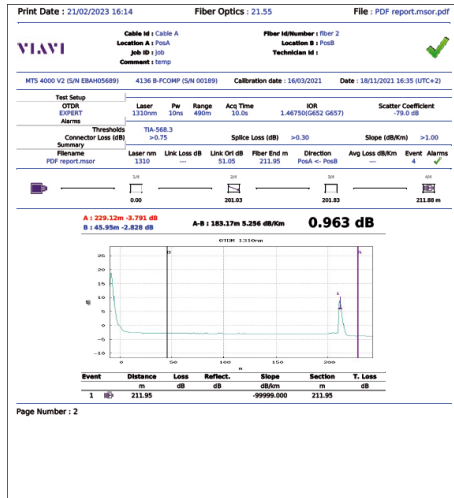

CAUTION

To modify the VIAVI logo, set by default on the header of the pdf report, save your logo in a jpg file called `logo.jpg` and place it to the root of the disk: `disk > logo.jpg`.



NOTE

A PDF Report can also be generated from the File Explorer page (see “[Generating pdf report\(s\)](#)” on page 87).

File management

The topics discussed in this chapter are as follows:

- “Description of the explorer” on page 80
- “Saving and loading files” on page 82
- “Exporting files” on page 84

Description of the explorer

Opening the file explorer

To access the Explorer, press **File** menu key from the **Results** page.

The explorer is used to:

- select the storage medium
- open a file
- create or rename directories and files:

The left-hand part presents the storage architecture. Click on the left of the screen to move around among all the media and their respective directories.

The right-hand part displays all the files present in the directory selected.

Figure 51 Example of explorer

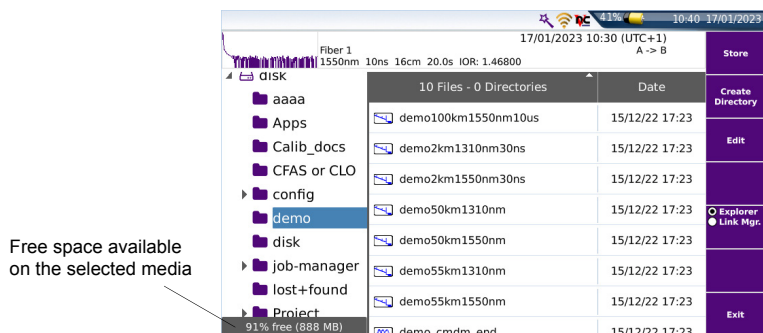

At the top of the screen, the file signature selected is repeated (see [Figure 52 on page 81](#)).

Managing tabs

Tabs give access to the File menu of each application present in the modules of the instrument.

It is possible to open a file even if the corresponding module is not present in the instrument. A new tab then temporarily manages this application.

File signature

The acquisition parameters of the trace contained in the selected file are displayed at the top of the screen together with a small-scale representation of the trace (provided it was acquired on a MTS / T-BERD).

Figure 52 Example of signature of an OTDR file (in the File Menu)

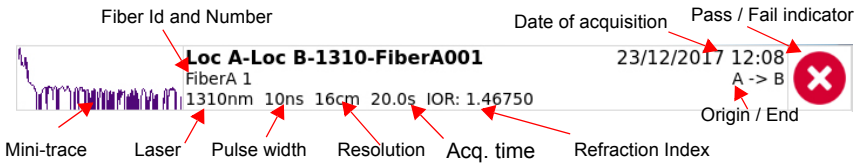

Buttons on the right of the screen

Saving traces

Three buttons are used to save one or more traces. Click on **Store** menu key and then select:

- **Save:** allows to save the current trace opened.
- **Save All:** allows to store all the traces displayed in overlay (OTDR) in one single file.
- The softkey **Next Trace** is used to activate the menu of the following trace, when several OTDR traces are in overlay.



Storage media

For saving or recalling data, the equipment offers a wide choice of media, both built-in and external.

Free space on selected media is clearly displayed at the bottom of the left panel.

Directories and files editing function

The directories or files can be copy/cut and paste, deleted or renamed from the Explorer:

- 1 Select the directory/file(s) to be pasted or deleted.

- 2 Click on **Edit** menu key.
- 3 Select the action to be performed.

Figure 53 Directory / File Editing functions

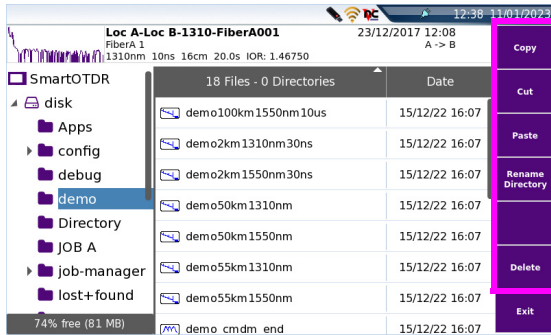

- 4 For directory or file paste, select a new directory and click **Paste** to paste the element.
For renaming directory or file, once the **Rename Directory/File** menu key is pressed, enter the new name in the Edition keyboard and click **✓** to validate.
For Directory/File deletion, once the **Delete** menu key is pressed, confirm the deletion clicking on **Yes** in the dialog box opened.

Saving and loading files

Saving files from the Explorer

When the explorer is displayed, the active trace for the selected tab is displayed in the File Signature.

You can then save the active trace:

- 1 Select a directory by clicking once on it.
- 2 Click on **Store** to save the active trace.
A new sub-menu displays.

- 3 Click on **Next Trace** to change the file signature on the top part of the screen and to save the next trace from traces in overlay.
- 4 Click on **Save All** or on **Save**.
The **Save All** menu key allows to save all the traces opened, whereas the **Save** menu key allows to save exclusively the trace described in the file signature.

Figure 54 Saving active trace from the explorer (with OTDR trace)

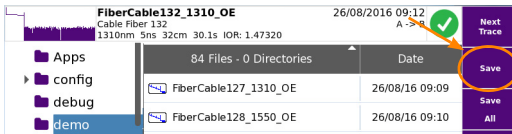

Displayed when two active overlaid traces are open.

The trace described in the file signature will be saved in the directory selected (in this example: demo)

This will open automatically the edition keyboard, in order to give a filename for the active trace.



The «Save» menu key is not available if the type of saving for OTDR files is defined to «All Traces» in the File Content parameter (see “File Content” on page 51).

Loading files and displaying traces

To access the functions for loading one or more files, select the file(s) in the explorer and press **Load**.

Simple loading

The key **View Trace(s)** enables simple loading of traces, using the current parameters of the MTS/T-BERD or OneAdvisor-800. The current trace is then replaced with this new trace.

Load with configuration

The key **Load Trace + Config** will display the traces, recalling the configuration recorded in the file. Thus the zooms, cursors and parameters present at the time of acquisition will be used for the display.

This function also enables to recall and set the parameters defined in the screens corresponding respectively to the File and Setup keys.

It is then possible to perform an acquisition under the same conditions as those of the trace recalled.

- If the product was equipped with a different module from the current one when the trace was acquired, certain configuration parameters cannot be updated. A message warns the user of this.
- If several traces are selected, the configuration used will be that of the first trace.
- If the number of traces added and the number of traces present is greater than 8, then the last traces added will not all be taken into account.



The configuration cannot be recalled if the trace was not originally created by the equipment.

Loading several traces in overlay

Up to 18 traces in the same application (OTDR) can be displayed simultaneously in overlay.

To obtain a display of multiple traces, two methods are possible:

- Select all the files to be loaded at the same time and click on **Load > View Trace(s)**
- Define a reference trace in a first time, open it, then come back to the explorer to select the other traces to be added (see [“Reference Trace function” on page 69](#)).

Exporting files

Click on the **Export** menu key allows to display a sub-menu from which selected files can be:

- generated into one/several reports
- merged into one file (for txt/pdf files only)

Explorer/Link Manager

Before exporting file(s), the display can be modified, and the Link Manager can be selected instead of the Explorer using the **Explorer/Link Mgr** menu key.

The Link Manager function allows to display the explorer with all the link information exclusively for the active application (the function must be activated in **Test** page, or at

least one result trace must be opened to get the tab and display files in the Link Manager page).

For example, if the **Link Mgr.** function is selected in the tab OTDR, only the link information from the OTDR files will be displayed (whether in multimode or singlemode). Select **Link Mgr** with the menu key **Explorer/Link Mgr.** to display the corresponding files for the active tab.

Figure 55 Explorer and Link Manager display

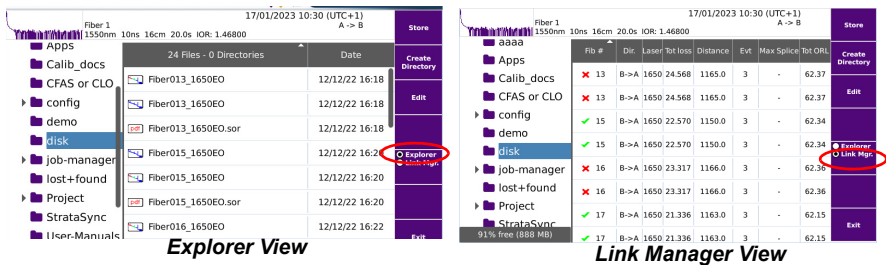

According to the application selected, the fiber information available are different. The table below describes the fiber information displayed for each selected tab:

NOTE
The files in the Link Manager window can be sorted according each column available for a tab.

Table 7 Fiber Information displayed

Column.	OTDR & OEO
1st	Alarm status (icon) & Fiber number
2nd	Direction
3rd	Lambda
4th	Total Loss
5th	Distance
6th	Nb of Event
7th	Max Splice
8th	Total ORL

Editing function

The same editing functions as those from the Explorer are available with the Link Manager function, except the merging function (as this is used with txt files):

See “[Directories and files editing function](#)” on page 81.

Moreover, from the **Link Manager** page, a whole directory can be exported , with the files corresponding to the active tab, in a txt file.

Exporting a directory in a txt file

- 1 Select the **Link Manager** function
- 2 Select the directory to open
- 3 Select one file from the list
- 4 Click on **Export > Export** menu key.

The txt file is automatically generated, in the same directory as the one selected for the export.

The name by default for the txt file is: *fiber_info_otdr.txt*.



NOTE

The txt file can be renamed once it is saved.

This file is made of two parts:

- The Header, with general information: the equipment used and its serial number, the date and time of export, the location of the file, and the number of files exported.
- The table, containing all the fibers information coming from the files of the active tab.

Once generated, the txt file can be transferred onto a PC and opened via a spreadsheet program (e.g. Excel...).

Figure 56 Example of a directory exported in a txt file (open with Excel)

Header of the txt file

Results

[Header]															
1	Text File Name:	1													
2	Base Name	MTS 4000 V2													
3	Base SN	EBAH08403													
4	Date	17/01/2023													
5	Time	11:11													
6	File Name	/disk/disk/fiber_info_otdr.txt													
7	Nb File	16													
8															
9															
10	[Results]														
11	Alarms	0 Files - 0 Div Dir.	Laser	Tot loss	Distance	Evt	Max Splice	Tot ORL	Max Connect Len.	Max Spl	Start connect	End connect	Launch Cable	Receive Cable	Start
12	FAIL	13 B->A	1650 24.568	1165.0	3	-	62.37	-	-	No	No	-	-	-	-
13	FAIL	13 B->A	1650 24.568	1165.0	3	-	62.37	-	-	No	No	-	-	-	-
14	PASS	15 B->A	1650 22.570	1150.0	3	-	62.34	-	-	No	No	-	-	-	-
15	PASS	15 B->A	1650 22.570	1150.0	3	-	62.34	-	-	No	No	-	-	-	-
16	FAIL	16 B->A	1650 23.317	1166.0	3	-	62.36	-	-	No	No	-	-	-	-
17	FAIL	16 B->A	1650 23.317	1166.0	3	-	62.36	-	-	No	No	-	-	-	-
18	PASS	17 B->A	1650 21.336	1163.0	3	-	62.15	-	-	No	No	-	-	-	-
19	PASS	17 B->A	1650 21.336	1163.0	3	-	62.15	-	-	No	No	-	-	-	-
20	PASS	18 B->A	1650 21.300	1163.0	3	-	62.17	-	-	No	No	-	-	-	-
21	PASS	18 B->A	1650 21.300	1163.0	3	-	62.17	-	-	No	No	-	-	-	-
22	PASS	19 B->A	1650 21.114	1160.0	3	-	62.08	-	-	No	No	-	-	-	-
23	PASS	19 B->A	1650 21.114	1160.0	3	-	62.08	-	-	No	No	-	-	-	-
24	PASS	20 B->A	1650 21.276	1161.0	3	-	62.15	-	-	No	No	-	-	-	-
25	PASS	20 B->A	1650 21.276	1161.0	3	-	62.15	-	-	No	No	-	-	-	-
26	PASS	21 B->A	1650 21.557	1163.0	3	-	62.13	-	-	No	No	-	-	-	-

Generating pdf report(s)

Several files of a same type (example: all OTDR files) can be generated in one/several pdf report(s).



- 1 Select the file(s) to be generated in a pdf report
 - 2 Press **Export > Report** menu keys.
 - 3 Using the menu key  select:
 - **1 Trace** if the report must be generated with one trace per page
 - **Multi** if the report must be generated with up to three traces per page (for OTDR files only).
 - 4 Click on **Build Report**.
 - 5 In the edition menu displayed, enter the name for the report
 - 6 Press  to validate and launch the report
- Once report is generated, a beep is emitted.

Figure 57 Report: 1 Trace and Multi (with OTDR files)



CAUTION

To modify the VIAVI logo, set by default on the header of the pdf report, save your logo in a jpg file called logo.jpg and place it to the root of the disk: disk > logo.jpg.

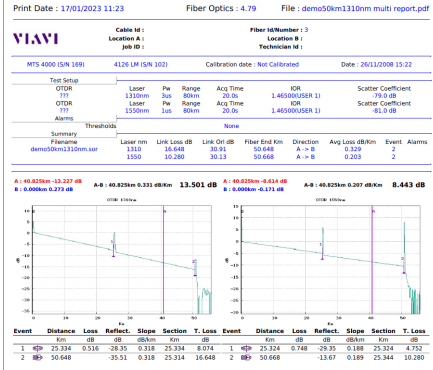

NOTE

The report is saved in the same directory as the selected files.

Using the Merge key, with the txt/pdf files

The txt or pdf files that have been saved/generated from a results page can be merged into one txt/pdf file from the Explorer.

The key **Merge** is used to merge several txt or pdf files into one file, putting together the results of all files.

- 1 In the explorer, select the txt/pdf files generated with the trace files you want.



The merging can be done exclusively from files of the same format. Pdf and txt files cannot be selected at the same time to generate a merged file.

- 2 Click on **Export > Merge** key
A beep is emitted once process is completed.

The file is saved with the filename: *merged_yyyy_mm_day_hr_mn_sec.pdf/txt*

It is automatically saved in the same directory as the one where the txt/pdf files have been selected.



NOTE

The file can be renamed once it is saved.

Technical specifications

This chapter shows the technical specifications of the OTDR modules and of the options available for the or T-BERD/MTS 2000 or SmartOTDR, and the OTDR technical specifications for SmartOTDR.

The topics discussed in this chapter are as follows:

- [“OTDR modules technical specifications” on page 92](#)
- [“Environment” on page 100](#)
- [“OTDR Technical specifications for SmartOTDR” on page 101](#)

**NOTE**

For specifications regarding the environment, refer to the Base-Unit user manual.

OTDR modules technical specifications

Characteristics of reflectometry measurements

Distance measurement

- Dual cursor
- Distance displayed takes into account the calibration of the refractive index of the fiber.
- Index adjustable from 1,30000 to 1,70000 in steps of 0,00001
- Resolution of display: 1 cm max.
- Resolution of cursor: 1 cm max.
- Spacing of measurement points: from 4 cm, with up to 256 000 acquisition points.
- Accuracy: $\pm 1\text{m} \pm \text{sampling resolution} \pm 10^{-5} \times \text{distance}$ for MM and QUAD (excluding errors of calibration of refractive index of the fiber).
 - $\pm 0.5\text{m} \pm \text{sampling resolution} \pm 10^{-5} \times \text{distance}$ for , A, B and C Modules (excluding errors of calibration of refractive index of the fiber).
- Display span: 3.25 m up to 400 km, according to the Module

Attenuation measurement

- Dual cursor
- Resolution of display: 0,001 dB
- Resolution of cursor: 0,001 dB
- Linearity: $\pm 0.05 \text{ dB/dB}$ with LA Modules
 - $\pm 0.03 \text{ dB/dB}$ with MA2, MA3, QUAD/MM, A, B and C Modules
- Display span: 1.25 dB to 55 dB

Reflectance Measurement

- Resolution of display: 0,01 dB
- Accuracy: $\pm 2 \text{ dB}$

Automatic measurement

- Automatic measurement of all the elements of the signal. Slope measurement by least squares or 2 points of measurement.
- Display threshold of faults:
 - 0 to 5.99 dB in steps of 0.01 dB for event thresholds

- -11 to -99 dB in steps of 1 dB for the reflectance
- 0.01 to 5.99 dB in steps of 0.01 dB for attenuation
- Display of slope and attenuation for a segment of fiber.
- Display of the position of a fault and of attenuation.
- Display of the reflectance of the fault.
- Display of ORL

Manual Measurement

- Measurement of slope between the cursors.
- Measurement of attenuation between two segments of fiber.
- Measurement of reflectance of a reflecting element.
- Measurement of ORL between the two cursors.
- Measurement of splice by 2 or 5 points method

Typical specifications

Typical values, measured at 25°C for all modules, unless specified.

Multimode Module

Multimode OTDR Module	41XXMM
Central Wavelength ¹	850 / 1300 nm ± 30 nm
Typical RMS Dynamic Range ²	26 / 24 dB
Distance Range	Up to 80 km
Pulse width	3 ns to 1 µs
Event Dead Zone ³	0.8 m
Attenuation Dead Zone ⁴	4 m

1. Laser in CW mode, at 25° C
2. Typical value corresponding to the difference (in dB) between the level of back-diffusion extrapolated at the beginning of the fiber and the RMS noise level, after 3 minutes of averaging, with the largest pulse width.
3. EDZ measured at +/- 1.5 dB below the peak of a non-saturated reflecting event at shortest pulse width.
4. ADZ measured at +/- 0.5 dB on the basis of a linear regression, using a - 40 dB type reflectance, at shortest pulse width.

A, B and C Modules

Singlemode Modules	41xxA	41xxB	41xxC
Central Wavelength ¹	1310 ± 20 nm ² 1550 ± 20 nm ² 1625 ± 15 nm	1310 ± 20 nm ² 1550 ± 20 nm ² 1625 ± 10 nm 1650 + 10/-5 nm	1310 ± 20 nm 1550 ± 20 nm 1625 ± 10 nm 1650 ± 15 nm
RMS Dynamic Range ³	37 dB 36 dB 36 dB	42 dB 40 dB 40 dB 40 dB	45 dB 43 dB 43 dB 42 dB
Distance Range	Up to 260 km		Up to 400 km
Pulse width	5 ns to 20 µs		
Event Dead Zone ⁴	0.7 m	0.65 m	
Attenuation Dead Zone ⁵	3 m		2.5 m
Typical Splitter Attenuation Dead Zone	-	45 m ⁶	20 m ⁷

1. Laser at 10 µs and 25° C
2. Laser in CW and 25° C
3. Typical value corresponding to the difference (in dB) between the level of back-diffusion extrapolated at the beginning of the fiber and the RMS noise level, after 3 minutes of averaging, with the largest pulse width.
4. EDZ measured at 1.5 dB below the peak of a non-saturated reflecting event at shortest pulse width.
5. ADZ measured at +/- 0.5 dB on the basis of a linear regression from a reflectance of type FC/UPC (-55 dB) at shortest pulse width.
6. Measured on a 16 dB loss (typical 1x32 split ratio) non-reflective splitter at 1310nm, using 200ns pulse-width.
7. Measured on a 16 dB loss (typical 1x32 split ratio) non-reflective splitter at 1310nm, using 100ns pulse-width

QUAD Module - E4146QUAD

	Multimode / Singlemode OTDR Module E4146QUAD	
Central Wavelength ¹	850 / 1300 nm ± 30 nm	1310 / 1550 nm ± 20 nm
Typical RMS Dynamic Range ²	26 / 24 dB	37 / 35 dB
Distance Range	Up to 80 km	Up to 260 km
Pulse width	3 ns to 1 µs	3 ns to 20 µs
Event Dead Zone ³	0.8 m	0.9 m
Attenuation Dead Zone	4 m ⁴	4 m ⁵

1. Laser in CW mode, at 25° C
2. Typical value corresponding to the difference (in dB) between the level of back-diffusion extrapolated at the beginning of the fiber and the RMS noise level, after 3 minutes of averaging, with the largest pulse width
3. EDZ measured at +/- 1.5 dB below the peak of a non-saturated reflecting event at shortest pulse width
4. ADZ measured at +/- 0.5 dB on the basis of a linear regression using a -40 dB type reflectance, at shortest pulse width.
5. ADZ measured at +/- 0.5 dB on the basis of a linear regression from a reflectance of type FC/UPC (-55 dB) at shortest pulse width, at 1310 nm.

QUAD Module - E4146A-PC/-APC

	Multimode / Singlemode OTDR Module E4146A-PC/-APC	
Central Wavelength ¹	850 / 1300 nm ± 30 nm	1310 / 1550 nm ± 20 nm
Typical RMS Dynamic Range ²	26 / 24 dB	37 / 35 dB
Distance Range	Up to 10 km	Up to 260 km
Pulse width	5 ns to 1 µs	5 ns to 20 µs
Event Dead Zone ³	0.55 m	0.65 m
Attenuation Dead Zone	3 m ⁴	3 m ⁵

1. Laser in CW mode, at 25° C
2. Typical value corresponding to the difference (in dB) between the level of back-diffusion extrapolated at the beginning of the fiber and the RMS noise level, after 3 minutes of averaging, at largest pulse width for singlemode, and at 500 ns for multimode
3. Measured at +/- 1.5 dB down from the peak of a non-saturated reflecting event at shortest pulse width
4. Measured at +/- 0.5 dB down from the linear regression using a -40 dB type reflectance, at shortest pulse width.
5. Measured at +/- 0.5 dB down from the linear regression from a reflectance of type FC/UPC (-55 dB) at shortest pulse width, at 1310 nm.

CWDM Modules

CWDM Modules	41CWDM8U	41CWDM10U	41CWDM10L
Central Wavelength ¹	1471 ±3 nm	1431 +/-3 nm	1271 ± 3 nm
	1491 ±3 nm	1451 +/-3 nm	1291 ± 3 nm
	1511 ±3 nm	1471 +/-3 nm	1311 ± 3 nm
	1531 ±3 nm	1491 +/-3 nm	1331 ± 3 nm
	1551 ±3 nm	1511 +/-3 nm	1351 ± 3 nm
	1571 ±3 nm	1531 +/-3 nm	1371 ± 3 nm
	1591 ±3 nm	1551 +/-3 nm	1391 ± 3 nm
	1611 ±3 nm	1571 +/-3 nm	1411 ± 3 nm
RMS Dynamic Range ²	35 dB		
Distance Range	Up to 260 km		
Pulse Width	10 ns to 20 µs		
Event Dead Zone ³	1.50 m		
Attenuation Dead Zone ⁴	5 m		
Output power of the source in continuous mode	-3.5 dBm		
Modes ⁵	CW, 270Hz, 330Hz, 1kHz, 2kHz		

1. Guaranteed, with laser at 25°C measured at 10 µs.
2. Value corresponding to the difference (in dB) between the backscattered level extrapolated at the origin of the fiber and the RMS noise level, after 3 minutes of averaging, with the largest pulsewidth.
3. EDZ measured at 1.5 dB below the peak of a non-saturated reflecting event at shortest pulsewidth.
4. ADZ measured at +/- 0.5 dB on the basis of a linear regression from a reflectance of type FC/PC (-55 dB) at shortest pulsewidth.
5. Remove 3 dB if used in modulation mode (270/330/1k/2kHz/Twintest/Auto)

DWDM Modules

DWDM Modules	41DWDMC	41FDWDMC
Wavelengths	C-Band tuning - C62 to C12 (1527.9 nm - 1567.95 nm)	
Channel Spacing	50/100/200 GHz	
Pulse Width	10 ns to 20 μ s	
RMS Dynamic Range ¹	44 dB	42.5 dB
Distance Range	Up to 260 km	
Event Dead Zone ²	1.50 m	
Attenuation Dead Zone ³	4 m	
Output power of the source in continuous mode	0 dBm	
Modes ⁴	CW, 270Hz, 330Hz, 1kHz, 2kHz	

1. Value corresponding to the difference (in dB) between the backscattered level extrapolated at the origin of the fiber and the RMS noise level , after 3 minutes of averaging, with the largest pulsewidth.
2. EDZ measured at 1.5 dB below the peak of a non-saturated reflecting event at shortest pulsewidth.
3. ADZ measured at +/- 0.5 dB on the basis of a linear regression from a reflectance of type FC/PC (-55 dB) at shortest pulsewidth.
4. Remove 3 dB if used in modulation mode (270/330/1k/2kHz/Auto)

Ranges

Ranges for A and B OTDR Modules

	5ns	10ns	30ns	100ns	200ns	500ns	1us	3us	10us	20us
100m	x	x	x							
200m	x	x	x							
500m	x	x	x							
1 km	x	x	x	x						
2 km	x	x	x	x	x	x				
5 km	x	x	x	x	x	x	x			
10 km	x	x	x	x	x	x	x			
20 km	x	x	x	x	x	x	x	x		
40 km	x	x	x	x	x	x	x	x	x	x
80 km			x	x	x	x	x	x	x	x
160 km					x	x	x	x	x	x
260 km							x	x	x	x

Ranges for C OTDR Modules

	5ns	10ns	30ns	100ns	200ns	500ns	1us	3us	10us	20us
100 m	x	x	x							
500 m	x	x	x							
1 km	x	x	x	x						
2 km	x	x	x	x	x	x				
5 km	x	x	x	x	x	x	x			
10 km	x	x	x	x	x	x	x			
20 km	x	x	x	x	x	x	x	x		
40 km	x	x	x	x	x	x	x	x	x	x
80 km			x	x	x	x	x	x	x	x
160 km					x	x	x	x	x	x
260 km							x	x	x	x
400 km									x	x

Ranges for Multimode Modules

	3 ns	10 ns	30 ns	100 ns	300 ns	1 μs
0.5 km	x	x				
1 km	x	x	x			
2 km	x	x	x	x		
5 km	x	x	x	x	x	
10 km	x	x	x	x	x	x
20 km		x	x	x	x	x
40 km				x	x	x
80 km				x	x	x

Ranges for CWDM Modules

	10 ns	30 ns	100 ns	300 ns	1 μ s	3 μ s	10 μ s	20 μ s
0,5 km	x	x						
1 km	x	x						
2 km	x	x	x					
5 km	x	x	x	x				
10 km	x	x	x	x	x			
20 km	x	x	x	x	x	x		
40 km	x	x	x	x	x	x	x	x
80 km		x	x	x	x	x	x	x
160 km				x	x	x	x	x
260 km						x	x	x

Ranges for DWDM Modules

	10 ns	30 ns	100 ns	300 ns	1 μ s	3 μ s	10 μ s	20 μ s
0,5 km	x	x						
1 km	x	x	x					
2 km	x	x	x	x				
5 km	x	x	x	x	x			
10 km	x	x	x	x	x			
20 km	x	x	x	x	x	x		
40 km	x	x	x	x	x	x	x	x
80 km		x	x	x	x	x	x	x
160 km			x	x	x	x	x	x
260 km						x	x	x

Class of the lasers of the OTDR modules

Module Standard	IEC 60825-1:2014	FDA21CFR§1040.10
Singlemode A, B and C OTDR Modules	Class1	Class 1
Multimode OTDR Modules	Class 1M @ 850 nm Class 1 @ 1300 nm	Class 1

OTDR modules measurement

Weight: approx. 300 g (0,66 lbs) (400g for the QUAD OTDR Module / 510g for the DWDM Module)

Dimensions (in mm) - w x h x d: 128 x 134 x 41

OTDR Module supply

OTDR modules are powered by the mainframe which they are attached to.

- Rated range supply 8 -15 VDC
- Maximum power consumption is 8 W

Environment

Indoor/outdoor

- Backlight high visibility color screen
- High visibility capacitive touchscreen for indoor and outdoor use.
- Altitude up to 4000m.



CAUTION

It is strongly recommended to work on the Platform in its glove when the product is used outdoors, in rainy weather.



CAUTION

AC/DC power supply must be used indoors!
The Platform battery charging must be performed indoors only!

Temperature

• Platform operating temperature range	Refer to platform's specification sheet
• Storage	-20°C to +60°C (-4°F to +140°F)

IEC 61010-1 Temperature range from 0 to 40°C.

Humidity

- 5 to 95% without condensation

Pollution degree

- Pollution degree: 2

VIAVI recommends that customers dispose of their instruments and peripherals in an environmentally sound manner. Potential methods include reuse of parts or whole products and recycling of products components, and/or materials.

Waste Electrical and electronic Equipment (WEEE) Directive

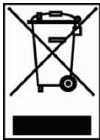

In the European Union, this label indicates that this product should not be disposed of with household waste. It should be deposited at an appropriate facility to enable recovery and recycling.

OTDR Technical specifications for SmartOTDR

OTDR Optical Interfaces

Switchable optical connectors: FC, LC, SC

OTDR Optical characteristics

Laser safety class (21 CFR)	Class 1
Distance units	Kilometer, meter, feet, and miles
Group index range	1.300000 to 1.700000 in 0.00001 steps
Number of data points	Up to 256,000 data points
Distance measurement	Automatic or dual cursor
Display range	0.1 km to 260 km for single-mode
Cursor resolution	1 cm
Sampling resolution	4 cm for single-mode





Accuracy	$\pm 1 \text{ m} \pm \text{sampling resolution} \pm 1.10\text{--}5 * x \text{ distance}$ (Excluding group index uncertainties)
-----------------	---

Warning labels



**Dangerous voltage (> 70VDC) is present inside of the product.
 Do not attempt to remove cover when product is in use.**

Due to the reduced dimensions of the optical modules, it is not always possible to attach the required warning labels to them. In line with the provisions of Article 7.2 of the IEC 60825-1 standard, the laser class identification labels are shown below:

Standard Ref.	IEC 60825-1:2014	FDA21CFR§1040.10
Class 1		
Class 1M		
Class 2		

The user must take the necessary precautions concerning the optical output of the instrument and follow the manufacturer's instructions.



Measurements on optical fibers are difficult to execute and the precision of the results obtained depends largely on the precautions taken by the user.

Characteristics of reflectometry measurements

Distance measurement

- Automatic or Dual cursor
- Distance displayed takes into account the calibration of the refractive index of the fiber.

- Index adjustable from 1,30000 to 1,70000 in steps of 0,00001
- Resolution of display: 1 cm max.
- Resolution of cursor: 1 cm max.
- Spacing of measurement points: from 4 cm, with up to 256 000 acquisition points.
- Accuracy: $\pm 1\text{m} \pm \text{sampling resolution} \pm 1 \cdot 10^{-5} \times \text{distance}$
(excluding errors of calibration of refractive index of the fiber).
- Display span: 0.1 km m to 260 km for single mode

Attenuation measurement

- Automatic, manual, 2-point, 5-point, and LSA
- Resolution of display: 0,001 dB
- Resolution of cursor: 0,001 dB
- Linearity: ± 0.04 dB/dB for single mode
- Display span: 1.25 dB to 55 dB

Reflectance / ORL Measurement

- Resolution of display: 0,01 dB
- Accuracy: ± 2 dB

Automatic measurement

- Automatic measurement of all the elements of the signal. Slope measurement by least squares or 2 points of measurement.
- Display threshold of faults:
 - 0 to 5.99 dB in steps of 0.01 dB for event thresholds
 - -11 to -99 dB in steps of 1 dB for the reflectance
 - 0.01 to 5.99 dB in steps of 0.01 dB for attenuation
- Display of slope and attenuation for a segment of fiber.
- Display of the position of a fault and of attenuation.
- Display of the reflectance of the fault.
- Display of ORL

Manual Measurement

- Measurement of slope between the cursors.
- Measurement of attenuation between two segments of fiber.
- Measurement of reflectance of a reflecting element.
- Measurement of ORL between the two cursors.
- Measurement of splice by 2 or 5 points method

Typical specifications

Typical values, measured at 25°C unless specified.

	100A Series	100AS Series	100B Series
Central Wavelength¹	1310 nm ± 20nm 1550 nm ± 20nm filtered 1650 nm ± 20 nm	1310 nm ± 20nm 1550 nm ± 20nm	1310 ± 20nm 1550 ± 20nm filtered 1625 nm ± 20nm filtered 1650 nm ± 20nm
Cut Wavelength range on live port (filtered)	1290 - 1580 nm Isolation > 45 dB		E136FB Module 1290 - 1580 nm Isolation > 45 dB E138FB65 Module 1260 - 1620 nm Isolation > 45 dB
Typical RMS Dynamic Range²	37 / 35 / 32 dB	30 / 30 dB	40 / 40 / 41 dB
Distance Range	Up to 260 km		
Pulse width	5 ns to 20µs		3 ns to 20µs
Event Dead Zone³	1.35 m		0.90 m
Attenuation Dead Zone⁴	4 m		2.5 m
Splitter Attenuation Dead Zone	40 m after 12dB splitter loss ⁵	NA	45 m after 15dB splitter loss ⁶

1. Laser, at 25° C and measured at 10 µs
2. Typical value corresponding to the one-way difference (in dB) between the extrapolated backscattering level at the beginning of the fiber and the RMS (SNR = 1) noise level, after 3 minutes averaging and high dynamic resolution, using the largest pulse width.
3. EDZ measured at ± 1.5 dB below the peak of a unsaturated reflective event using the shortest pulse width.
4. ADZ measured at ± 0.5 dB from the linear regression, using a FC/UPC- type reflectance, at shortest pulse width.
5. At 1650 nm
6. At 1550 nm

Characteristics of the Source (standard) and Power Meter (optional)

Source

- Output Power Level¹: -3.5 dBm
- Stability long term (8h): $\pm 0.05 \text{ dB}^2$

Power meter (through OTDR port)

Specifications given for 25°C, after 20 minutes stabilization time and after zero setting.

- Calibrated wavelengths: 1310 / 1490 / 1550 / 1625 / 1650 nm
- Accuracy at calibrated wavelengths: $\pm 0.5 \text{ dB}$ (at -30 dBm)
- Input power range: -60 dBm to +10 dBm
- Maximum resolution: 0.01 dB / 0.01nW
- Measurement range: 0 to -55 dBm
- Linearity: $\pm 0.5 \text{ dB}^3$

PON/XG-PON Power Meter (E118FA65PPM version)

- Wavelengths: 1490/1550 nm; 1490/1578 nm
- Measurement ranges
 - 1490 nm: -35 to +5 dBm
 - 1550/1578 nm: -35 to +23 dBm
- Measurement accuracy: $\pm 0.5 \text{ dB}$
- Channels isolation from external source:
 - 1310/1490: > 40dB
 - 1550 to 1650: > 20dB

1. +/- 1 dB
2. After 20min light source stabilization time
3. from -5 dBm to -50 dBm

Options and accessories

This chapter shows the references the measurement modules, the references for the SmartOTDR and the connectors/adapters references.

The topics discussed in this chapter are as follows:

- [“Commercial References of measurement modules for T-BERD/MTS-2000/4000 V2” on page 108](#)
- [“Commercial References of the SmartOTDR” on page 110](#)

Commercial References of measurement modules for T-BERD/MTS-2000/4000 V2

Product marking is based on the commercial reference excluding the first letter. Example : Commercial reference E4146QUAD is identified 4146QUAD on the product

OTDR Modules¹

Multimode Module

Modules	Commercial Reference
Multimode 850 / 1300 nm OTDR Module	E4123MM

Singlemode Module

A Modules	Commercial References
Module A OTDR 1310/1550 nm - PC/APC	E4126A-PC/-APC
Module A OTDR 1310/1625 nm - PC/APC	E4106A-PC/-APC
Module A OTDR 1310/1550/1625 nm - APC	E4136A-PC/-APC

B Modules	Commercial References
Module B OTDR 1310/1550 nm - PC/APC	E4126B-PC/-APC
Module B OTDR 1310/1550/1625 nm - PC/APC	E4136B-PC/-APC
Module B OTDR 1310/1550/Filtered 1650 nm - APC	E4138FB65-APC
Module B OTDR Filtered 1650 nm - APC	E4118FB65-APC

1. Specify optical connector of each OTDR ports

C Modules	Commercial References
Module C OTDR 1310/1550 nm - PC/APC	E4126C-PC/-APC
Module C OTDR 1310/1550/1625 nm - PC/APC	E4136C-PC/-APC
Module C OTDR 1310/1550/Filtered 1650 nm - APC	E4138FC65-APC
Module C OTDR 1310/1550/Filtered 1625 nm - APC	E4136FC65-APC

Multimode/Singlemode Modules	Commercial Reference
Multimode/Singlemode 850/1300/1310/1550 nm OTDR Module	E4146QUAD
Multimode/Singlemode 850/1300/1310/1550 nm OTDR Module with Light Source - PC	E4146A-PC
Multimode/Singlemode 850/1300/1310/1550 nm OTDR Module with Light Source - APC	E4146A-APC

CWDM OTDR Modules¹

Modules	Commercial References
CWDM OTDR Module from 1471nm to 1611nm for T-BERD/MTS2000 and 4000 V2	E41CWDM8U
CWDM OTDR Module from 1431nm to 1611nm for T-BERD/MTS2000 and 4000 V2	E41CWDM10U
CWDM OTDR Module from 1271nm to 1451nm for T-BERD/MTS2000 and 4000 V2	E41CWDM10L

DWDM OTDR Modules²

Modules	Commercial References
Tunable DWDM APC OTDR Module - C Band, with Tunable Light Source included	E41DWDMC-APC

1. Specify optical connector of each OTDR ports

Modules	Commercial References
Tunable DWDM PC OTDR Module - C Band, with Tunable Light Source included	E41DWDMC-PC
Filtered Tunable DWDM APC OTDR Module - C-Band	E41FDWDMC-APC
Filtered Tunable DWDM PC OTDR Module - C Band	E41FDWDMC-PC

Options

Mode Conditioner for Multimode fiber	Commercial References
Encircled flux mode conditioner embedded in a patchcord for 50 μ m multimode fiber in FC/PC	EFJEF50CONFCPC
Encircled flux mode conditioner embedded in a patchcord for 50 μ m multimode fiber in SC/PC	EFJEF50CONSCPC

Non Reflective Terminator Packages	Commercial References
SC/PC and SC/APC non-reflective terminator package	ENRTERMSC
FC/PC and FC/APC non-reflective terminator package	ENRTERMFC

Commercial References of the SmartOTDR

OTDR Configurations¹	Commercial References
SmartOTDR 1550nm AS Range Handheld Tester With Continuous Light Source & PC/APC Connector	E100AS-PC/-APC
SmartOTDR 1550nm A-Range Handheld Tester with Continuous Light Source & APC Connector	E100A-APC

- Specify optical connector of each OTDR ports

OTDR Configurations¹	Commercial References
SmartOTDR filtered 1650 nm A-Range Handheld Tester with APC connector	E118FA65-APC
SmartOTDR filtered 1650 nm A-Range Handheld Tester with PON-XGPON (1490/1550/1578 nm) Power meter and APC connector	E118FA65PPM-APC
SmartOTDR 1310/1550nm A-Range Handheld Tester with Continuous Light Source & PC connector	E126A-PC
SmartOTDR 1310/1550nm A-Range Handheld Tester with Continuous Light Source & APC connector	E126A-APC
SmartOTDR 1310/1550nm & Filtered 1625nm B-Range Handheld Tester with Continuous Light Source & PC connector ²	E136FB-PC
SmartOTDR 1310/1550nm & Filtered 1625nm B-Range Handheld Tester with Continuous Light Source & APC connector	E136FB-APC
SmartOTDR 1310/1550nm & Filtered 1650nm A-Range Handheld Tester with PC or APC connector	E138FA65-PC/-APC

1. Comes with AC/DC converter/adapter, hands-free carrying case, stylus and getting started manual.
OTDR connector adapter and battery type (LiPo mandatory for E126A and E136FB) are not included.
2. Available with SC OTDR connector adapter (EUSCADS) only

Index

A

- Accessories [107](#)
- Adapters
 - cleaning [6](#)
- Assistant [21](#)
- Attenuation [24](#)
 - Specifications [92](#), [103](#)

B

- Bend [23](#), [46](#), [53](#)

C

- Connection indicator [13](#), [56](#)
- Connector
 - cleaning [2](#)
 - link end [37](#)
 - link start [37](#)
 - test (config.) [36](#)
 - types [3](#)
- Cursor
 - Resolution [92](#), [103](#)

D

- Dead zone [65](#)
- Distance
 - Specif. OTDR measurement [92](#), [102](#)

DWDM [37–39](#)

E

- End of fiber [23](#)
- Environment [91](#)
- Event Code [28](#), [63](#)
- Event Details [19](#)
- Event line [18](#)
- Event memorization [70](#)
- Event OTDR [22](#), [64](#)
 - Icons [23](#)
- Expert OTDR
 - Acq. Time [35](#)
 - Acquisition [33](#)
 - Alarms Level [40](#)
 - Connector test [36](#)
 - icon [32](#)
 - Laser [33](#)
 - Launch Cable [36](#)
 - load configuration [55](#)
 - Real Time [35](#)
 - Smart Acq [34](#)

F

- Fans [2](#)
- Fiber end [46](#)
- File
 - Loading [83](#)

Save [82](#)
Signature [81](#)
File setup menu [80](#)
Five Pt Loss [69](#)

G

Ghost [23](#), [50](#)
Ghosts [46](#)

I

IBYC [3](#)
Index Of Refraction (IOR) [42](#)
Info bar [18](#)
IOR
 Specifications [92](#), [103](#)

L

Laser classes [99](#)
Launch cable End [23](#)
Link End [37](#)
Link Start [37](#)

M

Measurement
 Distance (specif.) [92](#), [102](#)
 Reflectance (specif.) [92](#), [103](#)
Multi-wavelength acquisition [59](#)
Mux/Demux [23](#), [46](#)

O

ORL [65](#), [67](#)
 Saturated trace [67](#)
OTDR
 Attenuation unit [42](#)
 Configuration [9](#), [32](#)
 Manual measurement

 2 points [68](#)
 5 points [69](#)
 ORL [67](#)
 Slope [65](#)
 Splice & Reflectance [68](#)
 Manual measurements [65](#)
 Measurement parameters [41](#)
 Module references [108](#)
 Options references [110](#)
 Results parameters [49](#)
 Specif. measurement [92](#), [102](#)
OTDR Events
 Delete [65](#)
 Hints [65](#)
 Representation [64](#)
OTDR module
 Size [100](#)
OTDR ranges [97](#)
Overlay traces
 Add [72](#)
 Display [71](#)
 Remove [72](#)

P

Positioning Cursors [16](#), [60](#)
Power meter
 specifications [105](#)
Pulse [33](#), [34](#)

R

Range [34](#)
Real Time [56](#)
Real time [35](#)
Receive cable Start [23](#)
REF mark [73](#)
Reference trace [73](#)
References [107](#)
Reflectance [24](#), [45](#), [67](#)
 Specifications [92](#), [103](#)
Resolution [35](#)

S

Saturated trace [67](#)
Scatter coefficient [44](#)
Shift [17](#), [25](#), [60](#)
Shift function [25](#)
Slope [23](#), [65](#), [66](#)
Smart Acq [34](#)
SmarTEST
 parameters [10](#)
SmartTEST
 config file [10](#)
 icon [9](#)
 process [8](#)
Specifications [91](#)
Splice [45](#), [65](#), [68](#)
Splitter [23](#)

T

Test cable [36](#)
Traffic detection [13](#), [57](#)
Two Pt Loss [68](#)

U

Units [49](#)

V

VIAVI screwdriver [5](#)

Z

Zoom [16](#), [25](#), [60](#)



700MAN201
Rev. 006, 09-23
English

VIAVI Solutions

North America: 1.844.GO VIAVI / 1.844.468.4284

Latin America +52 55 5543 6644

EMEA +49 7121 862273

APAC +1 512 201 6534

All Other Regions: [viavisolutions.com/contacts](https://www.viavisolutions.com/contacts)

email TAC@viavisolutions.com

address 6001 America Center Drive, San Jose, CA, 95002, USA