



3900 Series
Radio Test Set
Operation Manual



3900 Series

Digital Radio Test Set

Operation Manual

PUBLISHED BY
VIAVI Solutions, Inc.

COPYRIGHT © VIAVI Solutions, Inc. 2020

All rights reserved. No part of this publication may be reproduced, stored in a retrieval system, or transmitted in any form or by any means, electronic, mechanical, photocopying, recording or otherwise without the prior permission of the publisher.

Re-Issued Jan 2020

Declaration of Conformity

The Declaration of Conformity Certificate included with the Unit should remain with the Unit.

VIAVI recommends the operator reproduce a copy of the Declaration of Conformity Certificate to be stored with the Operation Manual for future reference.

THIS PAGE INTENTIONALLY LEFT BLANK.

Warranty Information

Warranty information for this product is available on the VIAVI website at <https://www.viavisolutions.com/en-us/warranty-information>.

THIS PAGE INTENTIONALLY LEFT BLANK.

Preface

ABOUT THIS MANUAL

This manual explains how to use Test Sets found in the 3900 Digital Radio Test Set Series. This Series currently includes the 3901, 3902 and 3920"x" Models. Unless otherwise indicated, information in this manual applies to the 3901, 3902 and 3920"x" Digital Radio Test Sets.

ELECTROMAGNETIC COMPATIBILITY

Double shielded and properly terminated external interface cables must be used with this equipment when interfacing with the RS-232 and IEEE-488.

For continued EMC compliance, all external cables must be shielded and 3 meters or less in length.

NOMENCLATURE STATEMENT

The 3901, 3902, 3920 and 3920B Digital Radio Test Set is the official nomenclature for the test sets currently included in the 3900 Digital Radio Test Set Series. In this manual, 3900, unit or Test Set, refers to the 3901, 3902, 3920 and 3920B Digital Radio Test Sets unless otherwise indicated.

NOTE	Some screen shots may reference frequencies above 1 GHz which are only applicable to specific 3900 models/options. Refer to product specifications for model operational parameters.
-------------	--

INTENDED AUDIENCE

This manual is intended for personnel familiar with radio test systems and associated equipment.

THIS PAGE INTENTIONALLY LEFT BLANK.

Service Upon Receipt of Material

UNPACKING

Special design packing material inside the shipping container provides maximum protection for the Test Set. Avoid damaging the shipping container and packing material when unpacking equipment; if necessary the shipping container and packing material can be reused to ship the Test Set.

CAUTION

To prevent personal injury or damage to Test Set, VIAVI recommends two people unpack the Test Set.

Use the following steps to unpack the Test Set:

STEP	PROCEDURE
------	-----------

1. Cut and remove sealing tape on top of shipping container. Open shipping container and remove accessory items and product documentation.
2. Grasp Test Set firmly while restraining shipping container. Lift Test Set and packing material vertically out of shipping container.
3. Place Test Set on a flat, clean and dry surface.
4. Remove accessory box from foam inserts.

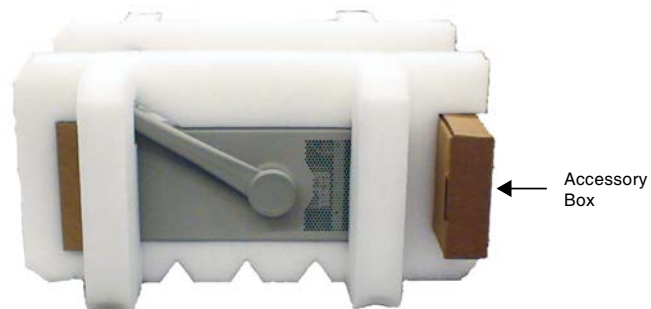

5. Remove foam inserts and cardboard insert from Test Set.

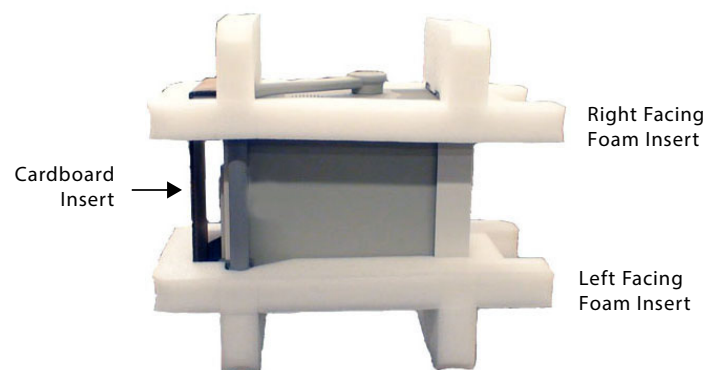

6. Store shipping container, accessory boxes and inserts for possible future use.

CHECKING UNPACKED EQUIPMENT

Inspect equipment for possible damage incurred during shipment. If Test Set had been damaged, report the damage to VIAVI Customer Service.

Review packing slip to verify shipment is complete. Packing slip identifies the following standard items as well as purchased options. Report all discrepancies to VIAVI.

Contact:

VIAVI
 Customer Service Department
 10200 West York Street
 Wichita, KS 67215
 Telephone: 800-835-2350
 Fax: 316-529-5330
 email: AvComm.Service@viavisolutions.com



Standard Items

Description	Part Number	QTY
Ship Unit (see Model Name)	Model Specific	1
3920	72412	
3920B	91164	
RTS Cord/Accessory Kit	63938	1

Description	Part Number	QTY
Ship Unit (see Model Name)	Model Specific	1
3901	72411	
3902	72410	
3900 Series Operation Manual (CD-ROM)	6047	1
3900 Series Getting Started Manual	6050	1
RTS Accessory Kit	63929	1
Power Cords Kit	63933	1

Precautions

SAFETY FIRST - TO ALL OPERATIONS PERSONNEL

GENERAL CONDITIONS OF USE

This product is designed and tested to comply with the requirements of IEC/EN61010-1 'Safety requirements for electrical equipment for measurement, control and laboratory use' for Class I portable equipment and is for use in a pollution degree 2 environment. The equipment is designed to operate from installation supply Category II.

Equipment should be protected from liquids such as spills, leaks, etc. and precipitation such as rain, snow, etc. When moving the equipment from a cold to hot environment, allow the temperature of the equipment to stabilize before it is connected to the supply to avoid condensation forming. The equipment must only be operated within the environmental conditions specified in the performance data.

This product is not approved for use in hazardous atmospheres or medical applications. If the equipment is to be used in a safety-related application, such as avionics or military applications, the suitability of the product must be assessed and approved for use by a competent person.

Refer all servicing of unit to Qualified Technical Personnel. This unit contains no operator serviceable parts.

WARNING	USING THIS EQUIPMENT IN A MANNER NOT SPECIFIED BY THE ACCOMPANYING DOCUMENTATION MAY IMPAIR THE SAFETY PROTECTION PROVIDED BY THE EQUIPMENT.
----------------	---

CASE, COVER OR PANEL REMOVAL

Opening the Case Assembly exposes the operator to electrical hazards that may result in electrical shock or equipment damage. Do not operate this Test Set with the Case Assembly open.

Precautions

SAFETY FIRST - TO ALL OPERATIONS PERSONNEL (cont)

SAFETY IDENTIFICATION IN TECHNICAL MANUAL

This manual uses the following terms to draw attention to possible safety hazards that may exist when operating or servicing this equipment.





CAUTION

IDENTIFIES CONDITIONS OR ACTIVITIES THAT, IF IGNORED, CAN RESULT IN EQUIPMENT OR PROPERTY DAMAGE, E.G., FIRE.

WARNING

IDENTIFIES CONDITIONS OR ACTIVITIES THAT, IF IGNORED, CAN RESULT IN PERSONAL INJURY OR DEATH.

Safety Symbols in Manuals and on Units

	CAUTION: Refer to accompanying documents. (This symbol refers to specific CAUTIONS represented on the unit and clarified in the text.)
	Indicates a Toxic hazard.
	Indicates item is static sensitive.
	AC TERMINAL: Terminal that may supply or be supplied with AC or alternating voltage.

EQUIPMENT GROUNDING PROTECTION

Improper grounding of equipment can result in electrical shock. Refer to [Chapter 2, Installation](#), for information on properly grounding the Test Set.

USE OF PROBES

Refer to [Appendix B, 3900 Platform Specifications](#), for the maximum voltage, current and power ratings of any connector on the Test Set before connecting it with a probe from a terminal device. Be sure the terminal device performs within these specifications before using it for measurement, to prevent electrical shock or damage to the equipment.

POWER CORDS

Power cords must be in good working condition. Power cords must not be frayed or broken, nor expose bare wiring when operating this equipment.

USE RECOMMENDED FUSES ONLY

Use only fuses specifically recommended for the equipment at the specified current and voltage ratings. Refer to [Chapter 2, Installation](#) and [Appendix B, 3900 Platform Specifications](#) for information on fuse requirements and specifications.

INTERNAL BATTERY

This unit contains a Lithium Ion Battery, serviceable only by a qualified technician.

SAFETY FIRST - TO ALL OPERATIONS PERSONNEL (cont)

EMI (ELECTROMAGNETIC INTERFERENCE

CAUTION

SIGNAL GENERATORS CAN BE A SOURCE OF ELECTROMAGNETIC INTERFERENCE (EMI) TO COMMUNICATION RECEIVERS. SOME TRANSMITTED SIGNALS CAN CAUSE DISRUPTION AND INTERFERENCE TO COMMUNICATION SERVICE OUT TO A DISTANCE OF SEVERAL MILES. USER OF THIS EQUIPMENT SHOULD SCRUTINIZE ANY OPERATION THAT RESULTS IN RADIATION OF A SIGNAL (DIRECTLY OR INDIRECTLY) AND SHOULD TAKE NECESSARY PRECAUTIONS TO AVOID POTENTIAL COMMUNICATION INTERFERENCE PROBLEMS.

ELECTRICAL HAZARDS (AC SUPPLY VOLTAGE)

WARNING

THIS EQUIPMENT IS PROVIDED WITH A PROTECTIVE GROUNDING LEAD THAT CONFORMS WITH IEC SAFETY CLASS I. TO MAINTAIN THIS PROTECTION THE SUPPLY LEAD MUST ALWAYS BE CONNECTED TO THE SOURCE OF SUPPLY VIA A SOCKET WITH A GROUNDED CONTACT.

BE AWARE THAT THE SUPPLY FILTER CONTAINS CAPACITORS THAT MAY REMAIN CHARGED AFTER THE EQUIPMENT IS DISCONNECTED FROM THE SUPPLY. ALTHOUGH THE STORED ENERGY IS WITHIN THE APPROVED SAFETY REQUIREMENTS, A SLIGHT SHOCK MAY BE FELT IF THE PLUG PINS ARE TOUCHED IMMEDIATELY AFTER REMOVAL.

DO NOT REMOVE INSTRUMENT COVERS AS THIS MAY RESULT IN PERSONAL INJURY. THERE ARE NO USER-SERVICEABLE PARTS INSIDE.

Refer all servicing to qualified personnel. See the list of VIAVI offices on the back of the manual.

Fuses

Note that the internal supply fuse is in series with the live conductor of the supply lead. If connection is made to a 2-pin unpolarized supply socket, it is possible for the fuse to become transposed to the neutral conductor, in which case, parts of the equipment could remain at supply potential even after the fuse has ruptured.

Definition of Installation Categories (ref IEC 664-1):

- | | |
|---------|--|
| CAT I | Circuits that are protected by devices limiting transient overvoltages to a low level, e.g., electronic circuits protected by filters. |
| CAT II | Circuits that are supply circuits for domestic or digital devices that may include transient overvoltages with an average value, e.g., power supply for household appliances and portable tools. |
| CAT III | Circuits that are supply circuits for power equipment that may include large transient overvoltages, e.g., power supply for industrial machines or equipment. |
| CAT IV | Circuits that may include very high transient overvoltages, e.g., supply distribution from power lines. |

SAFETY FIRST - TO ALL OPERATIONS PERSONNEL (cont)

FIRE HAZARD

WARNING

MAKE SURE THAT ONLY FUSES OF THE CORRECT RATING AND TYPE ARE USED FOR REPLACEMENT. IF AN INTEGRALLY FUSED PLUG IS USED ON THE SUPPLY LEAD, ENSURE THAT THE FUSE RATING IS COMMENSURATE WITH THE CURRENT REQUIREMENTS OF THIS EQUIPMENT.

Refer to [Appendix B, 3900 Platform Specifications](#) for power requirements.

TOXIC HAZARDS

WARNING

SOME OF THE COMPONENTS USED IN THIS EQUIPMENT MAY INCLUDE RESINS AND OTHER MATERIALS WHICH GIVE OFF TOXIC FUMES IF INCINERATED. TAKE APPROPRIATE PRECAUTIONS, THEREFORE, IN THE DISPOSAL OF THESE ITEMS.



Beryllia

WARNING

BERYLLIA (BERYLLIUM OXIDE) IS USED IN THE CONSTRUCTION OF SOME OF THE COMPONENTS IN THIS EQUIPMENT. THIS MATERIAL, WHEN IN THE FORM OF FINE DUST OR VAPOR AND INHALED INTO THE LUNGS, CAN CAUSE A RESPIRATORY DISEASE. IN ITS SOLID FORM, AS USED HERE, IT CAN BE HANDLED SAFELY, HOWEVER, AVOID HANDLING CONDITIONS WHICH PROMOTE DUST FORMATION BY SURFACE ABRASION. USE CARE WHEN REMOVING AND DISPOSING OF THESE COMPONENTS. DO NOT PUT THEM IN THE GENERAL INDUSTRIAL OR DOMESTIC WASTE OR DISPATCH THEM BY POST. THEY SHOULD BE SEPARATELY AND SECURELY PACKED AND CLEARLY IDENTIFIED TO SHOW THE NATURE OF THE HAZARD AND THEN DISPOSED OF IN A SAFE MANNER BY AN AUTHORIZED TOXIC WASTE CONTRACTOR.



Beryllium Copper

WARNING

SOME MECHANICAL COMPONENTS WITHIN THIS INSTRUMENT ARE MANUFACTURED FROM BERYLLIUM COPPER. THIS IS AN ALLOY WITH A BERYLLIUM CONTENT OF APPROXIMATELY 5%. IT REPRESENTS NO RISK IN NORMAL USE. THE MATERIAL SHOULD NOT BE MACHINED, WELDED OR SUBJECTED TO ANY PROCESS WHERE HEAT IS INVOLVED. IT MUST BE DISPOSED OF AS "SPECIAL WASTE." IT MUST NOT BE DISPOSED OF BY INCINERATION.

SAFETY FIRST - TO ALL OPERATIONS PERSONNEL (cont)

TOXIC HAZARDS (CONT)



Lithium

WARNING

A LITHIUM BATTERY IS USED IN THIS EQUIPMENT. LITHIUM IS A TOXIC SUBSTANCE SO THE BATTERY SHOULD IN NO CIRCUMSTANCES BE CRUSHED, INCINERATED OR DISPOSED OF IN NORMAL WASTE. DO NOT ATTEMPT TO RECHARGE THIS TYPE OF BATTERY. DO NOT SHORT CIRCUIT OR FORCE DISCHARGE SINCE THIS MIGHT CAUSE THE BATTERY TO VENT, OVERHEAT OR EXPLODE.

TILT FEATURE

WARNING

DO NOT STACK OTHER INSTRUMENTS ON TOP OF UNIT WHEN INSTRUMENT IS IN THE TILT POSITION.

INPUT OVERLOAD

CAUTION

DO NOT OVERLOAD THE TEST SET'S INPUT CONNECTORS. REFER TO THE PRODUCT SPECIFICATIONS FOR MAXIMUM INPUT RATING TO AVOID OVERLOADING INPUT CONNECTORS.

STATIC SENSITIVE COMPONENTS

CAUTION

THIS EQUIPMENT CONTAINS COMPONENTS SENSITIVE TO DAMAGE BY ELECTROSTATIC DISCHARGE (ESD). ALL PERSONNEL PERFORMING MAINTENANCE OR CALIBRATION PROCEDURES SHOULD HAVE KNOWLEDGE OF ACCEPTED ESD PRACTICES AND/OR BE ESD CERTIFIED.



CAUTION



THIS EQUIPMENT CONTAINS PARTS
SENSITIVE TO DAMAGE
BY ELECTROSTATIC DISCHARGE (ESD)

NOTE

To comply with EMC requirements, double shielded cables should be used for making connections to all input and output connectors.

SAFETY FIRST - TO ALL OPERATIONS PERSONNEL (cont)

SUITABILITY FOR USE

CAUTION

THIS EQUIPMENT HAS BEEN DESIGNED AND MANUFACTURED BY VIAVI TO GENERATE, RECEIVE AND ANALYZE RF/AUDIO SIGNALS.

IF THE EQUIPMENT IS NOT USED IN A MANNER SPECIFIED BY VIAVI, THE PROTECTION PROVIDED BY THE EQUIPMENT MAY BE IMPAIRED.

VIAVI HAS NO CONTROL OVER THE USE OF THIS EQUIPMENT AND CANNOT BE HELD RESPONSIBLE FOR EVENTS ARISING FROM ITS USE OTHER THAN FOR ITS INTENDED PURPOSE.

Table of Contents

General Information 1 - 1

1.1 . . . Introduction	1 - 1
1.2 . . . Test Set Features	1 - 1
1.3 . . . Test Set Usage	1 - 2
1.4 . . . Optional Test Systems and Functions	1 - 2
1.5 . . . Remote and Automatic Control	1 - 2

Installation 2 - 1

2.1 . . . Introduction	2 - 1
2.2 . . . Initial Visual Inspection	2 - 1
2.3 . . . Installation Requirements	2 - 1
2.3.1 Ventilation	2 - 1
2.3.2 Connecting to AC Power Supply	2 - 1
2.3.3 Disconnecting from AC Power Supply	2 - 1
2.3.4 AC Power Fuse	2 - 1
2.4 . . . Power Requirements	2 - 2
2.4.1 Class I Power Cords (3-core)	2 - 2
2.5 . . . Accessory Connectors	2 - 6
2.5.1 MIC/ACC Connector	2 - 6
2.5.2 GPIB Connector	2 - 7
2.5.3 RS-232 Serial Connector	2 - 8
2.5.4 Parallel Connector	2 - 8
2.5.5 Auxiliary IF Input	2 - 9
2.5.6 VGA Monitor Output	2 - 9
2.5.7 Ethernet and USB Connectors	2 - 10
2.5.8 PS/2 Interface Connectors	2 - 11
2.5.9 Test Connector	2 - 11
2.6 . . . Routine Safety Testing and Inspection	2 - 12
2.6.1 Earth Bonding Tests	2 - 12
2.6.2 Insulation Tests	2 - 12
2.6.3 Record Maintenance	2 - 12
2.6.4 External Cleaning	2 - 13
2.6.5 Visual Inspection	2 - 13
2.6.6 Carry Handle and Bench Support	2 - 13

Test Set Operation 3 - 1

- 3.1 . . . Introduction 3 - 1
- 3.2 . . . Front Panel Controls and Connectors 3 - 1
 - 3.2.1. Front Panel Connector Numerical Reference Guide 3 - 2
- 3.3 . . . Rear Panel Controls and Connectors 3 - 7
 - 3.3.1. Rear Panel Connector Numerical Reference Guide 3 - 7
- 3.4 . . . Turning Test Set On/Off 3 - 10
 - 3.4.1. Powering Test Set On 3 - 10
 - 3.4.2. Powering Test Set Down 3 - 12
- 3.5 . . . Test Set Factory Default Settings 3 - 13
 - 3.5.1. Initial Start-up in Factory Default State 3 - 13
 - 3.5.2. Reboot in Factory Default State 3 - 14
 - 3.5.3. Default Restore Options 3 - 15
- 3.6 . . . Modes of Operation 3 - 16
 - 3.6.1. TEST Mode 3 - 16
 - 3.6.2. CONFIG (Configuration) Mode 3 - 17
 - 3.6.3. UTILS (Utilities) Mode 3 - 18
- 3.7 . . . Display Layout 3 - 19
 - 3.7.1. Display Tile Status Bar 3 - 20
 - 3.7.2. Maximized and Minimized Views 3 - 22
 - 3.7.3. Navigating Display Tiles 3 - 23
 - 3.7.4. Floating Menus 3 - 23
- 3.8 . . . Display Components 3 - 24
 - 3.8.1. Drop-down Menus 3 - 24
 - 3.8.2. Data Entry Fields 3 - 24
 - 3.8.3. Tick Boxes 3 - 27
 - 3.8.4. Option Buttons 3 - 27
 - 3.8.5. Radio Buttons 3 - 27
 - 3.8.6. Soft Keys 3 - 28
- 3.9 . . . Limits 3 - 30
 - 3.9.1. Upper Limits 3 - 30
 - 3.9.2. Lower Limit 3 - 31
- 3.10 . . . Offsets 3 - 31
- 3.11 . . . Test Configurations and Setups 3 - 32
 - 3.11.1. Digital Radio System 3 - 32
 - 3.11.2. RF Input and Output Connectors 3 - 33
 - 3.11.3. One Port Duplex 3 - 33
 - 3.11.4. Two Port Duplex 3 - 34

Test Set Utility Tiles 4 - 1

- 4.1 . . .Introduction 4 - 1
- 4.2 . . .Accessing Utility Tiles 4 - 1
- 4.3 . . .Database Status Tile 4 - 2
 - 4.3.1. Soft Key Definitions 4 - 2
- 4.4 . . .Display Hold Tile 4 - 4
 - 4.4.1. Soft Key Definitions 4 - 4
- 4.5 . . .Error List Tile 4 - 5
 - 4.5.1. Query Errors 4 - 5
 - 4.5.2. Command Errors 4 - 5
 - 4.5.3. Device Errors 4 - 5
 - 4.5.4. Execution Errors 4 - 5
 - 4.5.5. Warnings Soft Key Definition 4 - 5
- 4.6 . . .File Management Tile 4 - 6
 - 4.6.1. File Management Types 4 - 6
 - 4.6.2. File Management Tile Layout and Navigation 4 - 7
 - 4.6.3. File Selection 4 - 7
 - 4.6.4. Samples 4 - 8
 - 4.6.5. Field/Soft Key Definitions 4 - 8
 - 4.6.6. Transferring Files 4 - 9
- 4.7 . . .Frequency Reference Tile 4 - 13
- 4.8 . . .Help System 4 - 14
 - 4.8.1. Soft Key Definitions 4 - 15
- 4.9 . . .Keyboard & Mouse Tile 4 - 16
 - 4.9.1. Field Definitions 4 - 16
- 4.10 . . .Language Select 4 - 17
- 4.11 . . .License Tile 4 - 18
 - 4.11.1. Test Set Options General Information 4 - 18
 - 4.11.2. Option Distribution 4 - 18
 - 4.11.3. New Option vs Option Update 4 - 18
 - 4.11.4. How to Install a New Software Option 4 - 19
- 4.12 . . .Operational Status Tile 4 - 20
 - 4.12.1. Field/Soft Key Definitions 4 - 20
- 4.13 . . .Printer Configuration Tile 4 - 21
 - 4.13.1. Field/Soft Key Definitions 4 - 21
 - 4.13.2. How to Install USB or Parallel Printer Connection 4 - 22
 - 4.13.3. How to Install Network Printer 4 - 23

Table of Contents

4.14 . . .Remote Tile	4 - 24
4.14.1. Field Definitions	4 - 24
4.14.2. Access Test Set via GPIB Connection (RCI Operation)	4 - 25
4.14.3. Access Test Set via Internet Browser (GUI Operation)	4 - 25
4.14.4. Access Test Set via VNC Connection (GUI Operation)	4 - 26
4.14.5. Access Test Set via Ethernet Connection (RCI Operation)	4 - 26
4.14.6. Access Test Set via WinSCP	4 - 27
4.15 . . .Software Upgrade Tile	4 - 29
4.15.1. Test Set Software General Information	4 - 30
4.15.2. Soft Key Definitions	4 - 31
4.15.3. How to Upgrade Software	4 - 31
4.16 . . .Store/Recall Tile	4 - 34
4.16.1. Soft Key Definitions	4 - 35
4.16.2. Managing Files	4 - 36
4.16.3. Numeric Indexing	4 - 38
4.17 . . .User Calibration Tile	4 - 39
4.17.1. Field/Soft Key Definitions	4 - 39
4.17.2. Run User Calibration Procedure	4 - 40

AutoTest II System Operation 5 - 1

5.1 . . .Introduction	5 - 1
5.2 . . .AutoTest II Command Structure	5 - 1
5.2.1. TCL Commands and Programming Structure	5 - 1
5.2.2. 3900 Remote Commands	5 - 1
5.3 . . .Selecting AutoTest II System	5 - 2
5.4 . . .Loading AutoTest II Scripts	5 - 2
5.5 . . .Exiting AutoTest II	5 - 3
5.6 . . .AutoTest II File Name Format	5 - 3
5.7 . . .AutoTest II Tile Components	5 - 3
5.7.1. Field/Soft Key Definitions	5 - 3
5.8 . . .AutoTest II Configuration Tile	5 - 5
5.8.1. Field Definitions	5 - 5
5.9 . . .Editor Mode	5 - 6
5.9.1. Accessing Editor Mode	5 - 6
5.10 . . .AutoTest II System Optional Test Scripts	5 - 8
5.10.1. Info Soft Key	5 - 8
5.10.2. Load System Soft Key	5 - 9
5.10.3. Instruments Soft Key	5 - 9
5.10.4. Store Recall Soft Key	5 - 9
5.10.5. Advanced Soft Key	5 - 9
5.10.6. Debug Soft Key	5 - 9
5.10.7. Return	5 - 9

Table of Contents

5.11	..AutoTest II Tutorials	5 - 10
5.11.1 tut1.tcl (Tutorial 1)	5 - 10
5.11.2 tut2.tcl (Tutorial 2)	5 - 10
5.11.3 tut3.tcl (Tutorial 3)	5 - 10
5.11.4 tut4.tcl (Tutorial 4)	5 - 10
5.11.5 tut5.tcl (Tutorial 5)	5 - 10
5.12	..Managing Results	5 - 10
5.12.1 Storing Results	5 - 10
5.12.2 Printing Results	5 - 10
5.13	..AutoTest II Commands	5 - 11
5.13.1 AX	5 - 11
5.13.2 delay "time - in milliseconds" "usrmsg - string"	5 - 11
5.13.3 print "string"	5 - 11
5.13.4 beep	5 - 11
5.13.5 rc "string"	5 - 12
5.13.6 clearresults	5 - 12
5.13.7 clearscreen	5 - 12
5.13.8 info1, info2, info3	5 - 12
5.13.9 abort	5 - 12
5.13.10 openprintfile	5 - 12
5.13.11 writeprintfile	5 - 12
5.13.12 closeprintfile	5 - 12
5.13.13 printfile	5 - 13
5.13.14 resettcpip	5 - 13
5.13.15 readch	5 - 13
5.13.16 showmain	5 - 13
5.13.17 showuser	5 - 13
5.13.18 setcustom	5 - 13
5.13.19 showcustom	5 - 13
5.13.20 clearcustom	5 - 13
5.13.21 pause	5 - 13
5.13.22 pauseFRA	5 - 14
5.13.23 pauseYN	5 - 14
5.13.24 addusermsg "string"	5 - 14
5.13.25 clearusermsg	5 - 14
5.13.26 displayusermsg	5 - 14
5.13.27 displayuserentry "string"	5 - 15
5.13.28 displaypicscreen "string" "file name"	5 - 15
5.13.29 debugstep "mode" "string"	5 - 15
5.13.30 AutoTest to Tcl Command	5 - 15
5.14	..Test Functions and Variables	5 - 16
5.14.1 Using Functions	5 - 16
5.14.2 Using Variables	5 - 19
5.15	..AutoTest II Command Conversion Chart	5 - 24

Radio Test Instruments 6 - 1

- 6.1 . . . Introduction 6 - 1
- 6.2 . . . Markers 6 - 1
 - 6.2.1 Enabling Markers 6 - 1
 - 6.2.2 Positioning Markers 6 - 1
 - 6.2.3 Marker Readings 6 - 2
 - 6.2.4 Marker Field Definitions 6 - 3
 - 6.2.5 Marker Soft Key Definitions 6 - 5
 - 6.2.6 Marker Configuration Tiles 6 - 8
- 6.3 . . . Channel Analyzer 6 - 9
 - 6.3.1 Basic Settings 6 - 9
 - 6.3.2 Field Definitions 6 - 9
 - 6.3.3 Soft Key Definitions 6 - 13
- 6.4 . . . Spectrum Analyzer 6 - 20
 - 6.4.1 Basic Settings 6 - 20
 - 6.4.2 Accessing the Spectrum Analyzer 6 - 20
 - 6.4.3 Spectrum Analyzer Tile Layout 6 - 21
 - 6.4.4 Field Definitions 6 - 21
 - 6.4.5 Soft Key Definitions 6 - 24
- 6.5 . . . Oscilloscope 6 - 31
 - 6.5.1 Basic Settings 6 - 31
 - 6.5.2 Accessing the Oscilloscope 6 - 31
 - 6.5.3 Oscilloscope Tile Layout 6 - 32
 - 6.5.4 Field Definitions 6 - 32
 - 6.5.5 Soft Key Definitions 6 - 34
- 6.6 . . . Digital Multimeter 6 - 38
 - 6.6.1 DMM Test Tile 6 - 38
 - 6.6.2 DMM Limits Configuration Tile 6 - 40
- 6.7 . . . Optional Instrument Functions 6 - 41
 - 6.7.1 Audio Analyzer (390XOPT055) 6 - 41
 - 6.7.2 Simulcast Analysis (390XOPT210) 6 - 48
 - 6.7.3 Analyzer OBW & Power Between Markers Option (390XOPT064) 6 - 50
 - 6.7.4 Spectrum Analyzer Tracking Generator Option (390XOPT061) 6 - 52

Analog Duplex System 7 - 1

- 7.1 . . . Introduction 7 - 1
- 7.2 . . . Accessing Analog Duplex System 7 - 2
- 7.3 . . . Analog Duplex Tile Layout 7 - 3
- 7.4 . . . Configuration Tiles 7 - 4
 - 7.4.1 AF Limits Configuration Tile 7 - 5
 - 7.4.2 AF Measurements Configuration Tile 7 - 6
 - 7.4.3 DMM Limits Configuration Tile 7 - 8
 - 7.4.4 DTMF Configuration Tile 7 - 9
 - 7.4.5 Frequency List Setup Configuration Tile 7 - 10
 - 7.4.6 Harmonics and Spurious Configuration Tile 7 - 16
 - 7.4.7 Modulation Limits Configuration Tile 7 - 17
 - 7.4.8 Modulation Measurements Configuration Tile 7 - 18
 - 7.4.9 Mod Noise Limits 7 - 20
 - 7.4.10 Offsets Configuration Tile 7 - 21
 - 7.4.11 Offsets Cable Loss Measurements 7 - 23
 - 7.4.12 Ports Configuration Tile 7 - 25
 - 7.4.13 RF Generator Configuration Tile 7 - 27
 - 7.4.14 RF Limits Configuration Tile 7 - 29
 - 7.4.15 RF Measurements Configuration Tile 7 - 30
 - 7.4.16 RF Modulation Configuration Tile 7 - 32
 - 7.4.17 Tone Sequential Configuration Tile 7 - 33
- 7.5 . . . Test Tiles 7 - 34
 - 7.5.1 Analyzers Tile 7 - 34
 - 7.5.2 Frequency List Test Tile 7 - 43
 - 7.5.3 Generators Tile 7 - 44
 - 7.5.4 Harmonics and Spurious Measurements (390XOPT060) 7 - 51
 - 7.5.5 IQ Gen Modulation (390XOPT054) 7 - 53
 - 7.5.6 Meters Tile 7 - 55
 - 7.5.7 Site Monitoring Application Test Option (390XOPT051) 7 - 61
 - 7.5.8 Tone Decoding Tile 7 - 67
 - 7.5.9 Tone Encoding Tile 7 - 68

3900 Optional Functions 8 - 1

8.1 . . . Introduction 8 - 1

8.2 . . . Optional Instrument Functions 8 - 1

8.2.1. Audio Analyzer (390XOPT055) 8 - 1

8.2.2. Simulcast Analysis (390XOPT210) 8 - 8

8.2.3. Spectrum Analyzer Tracking Generator Option (390XOPT061) 8 - 10

8.2.4. Analyzer OBW & Power Between Markers Option (390XOPT064) 8 - 11

8.3 . . . Optional Test and Measurement Functions 8 - 13

8.3.1. Harmonics and Spurious Measurements (390XOPT060) 8 - 13

8.3.2. Harmonics and Spurious Configuration Tile 8 - 14

8.3.3. IQ Gen Modulation (390XOPT054) 8 - 16

8.3.4. Site Monitoring Application Test Option (390XOPT051) 8 - 18

8.3.5. POCSAG Testing Option (390XOPT067) - Encoding 8 - 23

8.3.6. POCSAG Testing Option (390XOPT067) - Decoding 8 - 27

8.3.7. Selectivity Generator Tile 8 - 29

3900 Optional Test Scripts 9 - 1

9.1 . . . Introduction 9 - 1

9.2 . . . General Information 9 - 1

9.2.1 Loading Scripts 9 - 1

9.2.2 Enabling Tests 9 - 1

9.2.3 Main Tile Content 9 - 2

9.2.4 Common Script Functions 9 - 2

9.2.5 Common Soft Keys 9 - 2

9.2.6 Common Fields 9 - 8

9.3 . . . XTS™ 5000 Automatic Alignment System (390XOPT600) 9 - 10

9.3.1 Preliminary Procedures 9 - 10

9.3.2 Hardware Configuration 9 - 10

9.4 . . . XTS™ 3000 Automatic Alignment System (390XOPT601) 9 - 12

9.4.1 Preliminary Procedures 9 - 12

9.4.2 Hardware Configuration 9 - 12

9.5 . . . XTL Power Alignment Option (390XOPT602) 9 - 14

9.5.1 Enable XTL Power Alignment 9 - 14

9.5.2 Preliminary Procedures 9 - 14

9.5.3 Hardware Configuration 9 - 14

9.6 . . . TIA-603 LMR AutoTest Application (390XOPT603) 9 - 15

9.6.1 How to Use TIA-603 LMR AutoTest Application 9 - 15

9.7 . . . Motorola APX7000 Radio Alignment (390XOPT604) 9 - 16

9.7.1 Preliminary Procedures 9 - 16

9.7.2 Hardware Configuration 9 - 16

9.8 . . . EF Johnson 5100/5300 Radio Alignment (390XOPT606) 9 - 17

9.8.1 Preliminary Procedures 9 - 17

9.8.2 Hardware Configuration 9 - 17

9.9 . . . BK DPHx Radio Alignment (390XOPT607) 9 - 19

9.9.1 Preliminary Procedures 9 - 19

9.9.2 Hardware Configuration 9 - 19

9.10 . . . Kenwood P25 TK-5X10G Series Radio AutoTest/Alignment (390XOPT608) 9 - 20

9.10.1 Preliminary Procedures 9 - 20

9.10.2 Hardware Configuration 9 - 20

9.11 . . . MOTOTRBO Radio Series AutoTest/Alignment (390XOPT610) 9 - 23

9.11.1 Preliminary Procedures 9 - 23

9.11.2 Hardware Configuration 9 - 23

9.12 . . . Technisonics Type 1 Radio AutoTest/Alignment (390XOPT614) 9 - 24

9.13 . . . Technisonics Type 2 Radio AutoTest/Alignment (390XOPT615) 9 - 24

9.14 . . . DMR Repeater AutoTest (390XOPT626) 9 - 24

Shipping Test SetA - 1

A.1 . . . Repacking for Shipping A - 1
A.1.1 Return Authorization A - 1
A.2 . . . Tagging Test Sets A - 1
A.3 . . . Shipping Containers A - 1
A.4 . . . Freight Costs A - 1
A.5 . . . Repacking Procedure A - 2

3900 Platform SpecificationsB - 1

B.1 . . . RF Signal Generator B - 1
B.1.1 Frequency B - 1
B.1.2 Output Level B - 1
B.1.3 Spectral Purity B - 2
B.1.4 Modulation B - 3
B.2 . . . RF Receiver B - 6
B.2.1 Demodulation Selections B - 6
B.2.2 Frequency Range (Usable from 100 kHz) B - 6
B.2.3 Sensitivity B - 6
B.2.4 Selectivity B - 6
B.2.5 Demod Output Level B - 6
B.3 . . . RF Receive Measurements B - 7
B.3.1 AM Meter B - 7
B.3.2 FM Deviation Meter B - 8
B.3.3 RF Counter B - 8
B.3.4 RF Error Meter B - 9
B.3.5 Demodulation B - 9
B.3.6 RF Power Meter (Broad band) B - 10
B.3.7 RF Power Meter (In Band) B - 10
B.4 . . . Audio Function Generator(s) B - 11
B.4.1 Waveshape B - 11
B.4.2 Frequency B - 11
B.4.3 Level (Sine) B - 11
B.4.4 Impedance B - 11
B.4.5 Spectral Purity B - 11
B.5 . . . Audio & Modulation Measurements B - 12
B.5.1 AF Counter B - 12
B.5.2 AF Level Meter B - 13
B.5.3 SINAD Meter B - 14
B.5.4 Distortion Meter B - 15
B.5.5 Hum and Noise B - 16
B.5.6 Signal to Noise Ratio B - 17
B.5.7 Audio Filters (Characteristic Response) B - 18

Table of Contents

B.6 . . . Channel Analyzer	B - 19
B.6.1 Frequency	B - 19
B.6.2 Span	B - 19
B.6.3 Level	B - 19
B.6.4 Resolution Bandwidth	B - 19
B.6.5 Sweep	B - 19
B.7 . . . RF Spectrum Analyzer	B - 20
B.7.1 Frequency	B - 20
B.7.2 Span	B - 20
B.7.3 Display Accuracy	B - 20
B.7.4 Markers	B - 20
B.7.5 Level	B - 21
B.7.6 Resolution Bandwidth	B - 22
B.7.7 Video Bandwidth	B - 22
B.7.8 Sweep	B - 22
B.7.9 Function/Feature	B - 23
B.8 . . . Tracking Generator (Option)	B - 24
B.8.1 Tracking Generator Output	B - 24
B.8.2 Span and Sweep Time	B - 24
B.8.3 Tracking Generator Controls	B - 24
B.9 . . . Oscilloscope	B - 25
B.9.1 Display	B - 25
B.9.2 Vertical	B - 25
B.9.3 Horizontal	B - 26
B.9.4 Trigger	B - 26
B.10 . . . Frequency Standard I/O	B - 27
B.10.1 Internal Frequency Standard Output (OCXO)	B - 27
B.10.2 External Frequency Input	B - 27
B.11 . . . Audio Spectrum Analyzer (Option)	B - 28
B.11.1 Frequency Range	B - 28
B.11.2 Resolution	B - 28
B.11.3 Accuracy	B - 28
B.11.4 Span	B - 28
B.11.5 Level	B - 28
B.11.6 Markers	B - 28
B.12 . . . Digital Multimeter (3920 Only)	B - 29
B.12.1 AC/DC Voltmeter	B - 29
B.12.2 AC/DC AM Meter	B - 29
B.12.3 Ohm Meter	B - 29
B.12.4 External Shunt (Optional Accessory)	B - 30

Table of Contents

B.13 . . .Input/Output Connectors	B - 31
B.13.1 ANT (RF Input)	B - 31
B.13.2 T/R (RF Input/Output)	B - 31
B.13.3 GEN (RF Output)	B - 32
B.13.4 GPIB	B - 32
B.13.5 Ethernet	B - 32
B.13.6 RS-232	B - 32
B.13.7 Video	B - 33
B.13.8 IF Output	B - 33
B.13.9 MIC/Accessory	B - 33
B.13.10 Parallel Port	B - 33
B.13.11 USB	B - 33
B.13.12 PS/2 Interfaces (3901/3902 only)	B - 34
B.13.13 Test Port	B - 34
B.13.14 Auxiliary IF Input	B - 34
B.14 . . .Environmental	B - 35
B.14.1 Operating Temperature	B - 35
B.14.2 Warm-up Time	B - 35
B.14.3 Storage Temperature	B - 35
B.14.4 Relative Humidity	B - 35
B.14.5 Altitude	B - 35
B.14.6 Shock and Vibrations	B - 35
B.14.7 Use	B - 35
B.14.8 EMC	B - 35
B.14.9 Reliability	B - 35
B.15 . . .Safety Standards	B - 35
B.16 . . .Dimensions and Weight	B - 35
B.17 . . .AC Power Requirements	B - 36
B.17.1 Voltage	B - 36
B.17.2 Power Consumption	B - 36
B.17.3 Mains Supply Voltage Fluctuations	B - 36
B.17.4 Fuse Requirements	B - 36
B.18 . . .General Features	B - 36
B.18.1 LCD Display	B - 36
B.18.2 Disk Storage (3901/3902 only)	B - 36

Fuse Replacement InstructionsC - 1

AbbreviationsD - 1

Common Features Quick Reference GuideE - 1

Optional Test Systems and FunctionsF - 1

Error Messages G - 1

 G.1 . . . Command Errors G - 1

 G.2 . . . Device Specific Errors G - 3

 G.3 . . . Execution Errors G - 6

 G.4 . . . Query Errors G - 7

Tone Encoding/Decoding Frequency MappingH - 1

THIS PAGE INTENTIONALLY LEFT BLANK.

List of Figures

FIGURE	PAGE
Fig. 1-1 3920 Digital Radio Test Set	1 - 1
Fig. 2-1 Wire-Ended Class I Power Cord	2 - 2
Fig. 2-2 British Class I Power Cord	2 - 3
Fig. 2-3 North American Class I Power Cord	2 - 3
Fig. 2-4 Continental Europe Class I Power Cord	2 - 4
Fig. 2-5 MIC/ACC Pin Locations	2 - 6
Fig. 2-6 GPIB Connector Pin Locations	2 - 7
Fig. 2-7 Serial Connector Pin Locations	2 - 8
Fig. 2-8 Parallel Connector Pin Locations	2 - 8
Fig. 2-9 VGA Monitor Output Pin Locations	2 - 9
Fig. 2-10 Ethernet and USB Connector Pin Locations	2 - 10
Fig. 2-11 PS/2 Connector Pin Locations	2 - 11
Fig. 2-12 Test Connector Pin Locations	2 - 11
Fig. 3-1 3901/3902 Front Panel Connectors	3 - 1
Fig. 3-2 3920/3920B Front Panel Connectors	3 - 1
Fig. 3-3 3900 Series Rear Panel Connectors	3 - 7
Fig. 3-4 Factory Default Tile	3 - 11
Fig. 3-5 System Shut-Down Prompt Dialog Box	3 - 12
Fig. 3-6 Factory Default Display Tile	3 - 13
Fig. 3-7 Power On Blue Screen "X"	3 - 14
Fig. 3-8 Restore Factory Defaults - Restore Selections	3 - 15
Fig. 3-9 System/Configuration Floating Menu	3 - 16
Fig. 3-10 Analog Duplex Configuration Floating Menu	3 - 17
Fig. 3-11 UTILS Floating Menu - Hardware Settings Selected	3 - 18
Fig. 3-12 Analog Duplex System Display - Minimized View	3 - 19
Fig. 3-13 Status Bar Fields	3 - 20
Fig. 3-14 Status Bar Content Diagram	3 - 20
Fig. 3-15 P25 Optional System - Channel Plan Field	3 - 21
Fig. 3-16 Minimized - Maximized Viewing Options	3 - 22
Fig. 3-17 Channel Analyzer Maximized - TAB Floating Menu of Active Tiles	3 - 23
Fig. 3-18 Numeric Entry - Selected Edit States	3 - 24
Fig. 3-19 Data Field Background Colors	3 - 25
Fig. 3-20 Pass/Fail Indicators	3 - 25
Fig. 3-21 Numeric Output and Limit Settings Readouts	3 - 26
Fig. 3-22 Tick Buttons - Enable/Disable Mod Generators	3 - 27

List of Figures

FIGURE	PAGE
Fig. 3-23 Option (Toggle) Buttons	3 - 27
Fig. 3-24 Radio Buttons - Measurement Results Selection	3 - 27
Fig. 3-25 Analog Duplex - Limits Enabled	3 - 30
Fig. 3-26 Generator and Analyzer Offset Indicators	3 - 31
Fig. 3-27 Basic Test Setup	3 - 32
Fig. 3-28 One Port Duplex Test Setup	3 - 33
Fig. 3-29 GEN/ANT Two Port Duplex Test Setup	3 - 34
Fig. 3-30 GEN/TR Two Port Duplex Test Setup	3 - 34
Fig. 3-31 TR/ANT Two Port Duplex Test Setup	3 - 34
Fig. 4-2 Database Status Tile	4 - 2
Fig. 4-3 HOLD Display Tile	4 - 4
Fig. 4-5 File Management Tile	4 - 6
Fig. 4-6 File Management Tile Layout	4 - 7
Fig. 4-7 File Management - Multiple Files Selected	4 - 7
Fig. 4-8 File Management - File Delete Confirmation Prompt	4 - 8
Fig. 4-9 File Management - Selecting File	4 - 9
Fig. 4-10 File Management Tile - File Selected to Copy	4 - 10
Fig. 4-11 File Management Tile - Copy Complete	4 - 10
Fig. 4-12 Select Internal Drive	4 - 11
Fig. 4-13 Select External Drive	4 - 11
Fig. 4-14 File Management - File Selected	4 - 12
Fig. 4-15 UTILS Frequency Reference Tile	4 - 13
Fig. 4-16 Reference Unlocked Error Message	4 - 13
Fig. 4-17 Main Help Tile	4 - 14
Fig. 4-18 Example of Help File Contents	4 - 14
Fig. 4-19 UTILS Keyboard & Mouse Tile	4 - 16
Fig. 4-20 Language Select Tile	4 - 17
Fig. 4-21 Chinese Language Support	4 - 17
Fig. 4-22 UTILS Software License Tile	4 - 18
Fig. 4-23 Directory Format for License Installation	4 - 19
Fig. 4-24 Operational Status Tile	4 - 20
Fig. 4-25 UTILS Printer Configuration Tile - Main Tile	4 - 21
Fig. 4-26 USB Printer Installation Complete	4 - 22
Fig. 4-27 Network Printer Setup - Available Printers	4 - 23
Fig. 4-28 Network Printer Installation Complete	4 - 23
Fig. 4-29 UTILS Remote Tile	4 - 24
Fig. 4-30 GPIB Go To Local Soft Key	4 - 25
Fig. 4-31 Command Window Example	4 - 26
Fig. 4-32 WinSCP Login Window (Version 4.1.8.415)	4 - 27

List of Figures

FIGURE	PAGE
Fig. 4-33 WinSCP Window (Version 4.1.8.415)	4 - 27
Fig. 4-34 WinSCP Transfer Preferences - Disable Timestamp	4 - 28
Fig. 4-35 Accessing Software Upgrade Function	4 - 29
Fig. 4-36 System Software Information	4 - 30
Fig. 4-37 Defaults Tile	4 - 32
Fig. 4-38 Software Upgrade - Confirm Upgrade Process	4 - 33
Fig. 4-39 Accessing Store/Recall Tile	4 - 34
Fig. 4-40 Save/Recall Tile	4 - 34
Fig. 4-41 Creating a Settings File	4 - 36
Fig. 4-42 Store/Recall Dialog Box	4 - 37
Fig. 4-43 Creating New Directory	4 - 38
Fig. 4-44 UTILS User Calibration Tile	4 - 39
Fig. 4-45 User Calibration Tile	4 - 40
Fig. 5-1 Use of rc in AutoTest II Script	5 - 1
Fig. 5-2 AutoTest II Main Tile	5 - 2
Fig. 5-3 AutoTest II Tile Layout	5 - 3
Fig. 5-4 Remote Command Validation	5 - 4
Fig. 5-5 AutoTest II Configuration Tile	5 - 5
Fig. 5-6 Accessing AutoTest II Editor Tool	5 - 6
Fig. 5-7 Script File in Editor Mode	5 - 7
Fig. 5-8 AutoTest II - Script Option Buttons	5 - 8
Fig. 5-9 Information Tile Example - Motorola ASTRO P25 Autotest	5 - 8
Fig. 5-10 AutoTest II System - Advanced Tile	5 - 9
Fig. 6-1 Marker Readings	6 - 2
Fig. 6-2 Channel Analyzer Marker Field/Toggle Buttons	6 - 3
Fig. 6-3 Scope Marker Field/Toggle Buttons	6 - 3
Fig. 6-4 Markers Soft Key Sub-menus	6 - 5
Fig. 6-5 Markers 1 and 2 - LOCKED State	6 - 5
Fig. 6-6 LOCKED Markers - Repositioned While in LOCKED State	6 - 6
Fig. 6-7 Mkr 1/Mkr 2 Soft Key Sub-menu	6 - 6
Fig. 6-8 Toggle Marker Soft Key	6 - 7
Fig. 6-9 Audio Analyzer Markers Configuration Tile	6 - 8
Fig. 6-10 Spectrum Analyzer Markers Configuration Tile	6 - 8
Fig. 6-11 Channel Analyzer Start and Stop Frequency Setting	6 - 10
Fig. 6-12 Channel Analyzer Center Frequency and Span Setting	6 - 11
Fig. 6-13 Channel Analyzer Zero Span Example	6 - 11
Fig. 6-14 Channel Analyzer Absolute Setting	6 - 12
Fig. 6-15 Channel Analyzer Relative Setting	6 - 12
Fig. 6-16 Channel Analyzer - Ref Level and Scale Settings	6 - 13

List of Figures

FIGURE	PAGE
Fig. 6-17 Channel Analyzer Start and Stop Frequency Setting	6 - 14
Fig. 6-18 Channel Analyzer Coupling Soft Key Menu	6 - 15
Fig. 6-19 Channel Analyzer Sweep and Averaging Progress Bars	6 - 16
Fig. 6-20 Channel Analyzer Trace Soft Key	6 - 17
Fig. 6-21 Channel Analyzer with Trigger Soft Keys	6 - 19
Fig. 6-22 Accessing Spectrum Analyzer - TEST Floating Menu	6 - 20
Fig. 6-23 Spectrum Analyzer Tile	6 - 21
Fig. 6-24 Spectrum Analyzer Start and Stop Frequency Setting	6 - 22
Fig. 6-25 Spectrum Analyzer Center Frequency and Span Setting	6 - 23
Fig. 6-26 Spectrum Analyzer Zero Span Example	6 - 23
Fig. 6-27 Spectrum Analyzer Vertical Settings Tile	6 - 24
Fig. 6-28 Spectrum Analyzer Horizontal Settings Tile	6 - 25
Fig. 6-29 Spectrum Analyzer Coupling Soft Key Menu	6 - 26
Fig. 6-30 Spectrum Analyzer - All Markers Enabled	6 - 27
Fig. 6-31 Spectrum Analyzer with Live, Peak and Captured Traces	6 - 28
Fig. 6-32 Spectrum Analyzer with Live Trace	6 - 30
Fig. 6-33 Accessing the Oscilloscope	6 - 31
Fig. 6-34 Oscilloscope Tile - Maximized View	6 - 32
Fig. 6-35 Oscilloscope Tile - Vertical Settings	6 - 34
Fig. 6-36 Scope Expand/Contract Soft Keys	6 - 34
Fig. 6-37 Oscilloscope Trace Soft Keys	6 - 35
Fig. 6-38 Oscilloscope Captured Traces	6 - 36
Fig. 6-39 Oscilloscope Trigger Soft Keys	6 - 37
Fig. 6-40 DMM Tile - Maximized View	6 - 38
Fig. 6-41 DMM Shunt Installation Prompt Dialog Box	6 - 39
Fig. 6-42 Shunt Installed	6 - 39
Fig. 6-43 DMM Limits Configuration Tile	6 - 40
Fig. 6-44 Accessing Audio Analyzer	6 - 41
Fig. 6-45 Audio Analyzer Tile - Maximized View	6 - 42
Fig. 6-46 Log Scaling Selected	6 - 43
Fig. 6-47 Audio Analyzer - Ref Level and Scale Settings	6 - 44
Fig. 6-48 Audio Analyzer Start and Stop Frequency Setting	6 - 44
Fig. 6-49 Audio Analyzer Trace Soft Keys	6 - 45
Fig. 6-50 Audio Analyzer - Trace Limits Enabled	6 - 47
Fig. 6-51 Audio Analyzer - Rx Bandpass Sweep	6 - 48
Fig. 6-52 Audio Analyzer - Tx Bandpass Sweep	6 - 48
Fig. 6-53 Spectrum Analyzer - Power Between Markers Measurement	6 - 50
Fig. 6-54 Spectrum Analyzer - Occupied Bandwidth at 99%	6 - 50
Fig. 6-55 Spectrum Analyzer - Occupied Bandwidth at 75%	6 - 51

List of Figures

FIGURE	PAGE
Fig. 6-56 Spectrum Analyzer Tile - Tracking Generator Parameters	6 - 52
Fig. 7-1 Selecting Analog Duplex System	7 - 2
Fig. 7-2 Analog Duplex System - TEST Mode - Minimized Tiles	7 - 3
Fig. 7-3 AF Limits Configuration Tile	7 - 5
Fig. 7-4 AF Measurements Configuration Tile	7 - 6
Fig. 7-5 DMM Limits Configuration Tile	7 - 8
Fig. 7-6 DTMF Configuration Tile	7 - 9
Fig. 7-7 Frequency List Setup Configuration Tile	7 - 10
Fig. 7-8 Frequency List - Import/Export Soft Key Submenu	7 - 11
Fig. 7-9 Frequency List - Configure List	7 - 12
Fig. 7-10 Frequency List - Store File Dialog Window	7 - 13
Fig. 7-11 Frequency List - Store File Dialog Window	7 - 13
Fig. 7-12 Frequency List - Stored File Available	7 - 14
Fig. 7-13 Frequency List - Format Example	7 - 14
Fig. 7-14 Harm & Spur Limits Configuration Tile	7 - 16
Fig. 7-15 Analog Duplex - Mod Limits Configuration Tile	7 - 17
Fig. 7-16 Analog Duplex - Modulations Measurements Configuration Tile	7 - 18
Fig. 7-17 Mod Noise Limits Configuration Tile	7 - 20
Fig. 7-18 Offsets Configuration Tile	7 - 21
Fig. 7-19 Cable Loss Parameters Enabled	7 - 23
Fig. 7-20 Cable Loss Tables	7 - 24
Fig. 7-21 Ports Configuration Tile	7 - 25
Fig. 7-22 RF Generator Configuration Tile	7 - 27
Fig. 7-23 RF Limits Configuration Tile	7 - 29
Fig. 7-24 RF Measurements Configuration Tile	7 - 30
Fig. 7-25 Modulation Generator Configuration Tile	7 - 32
Fig. 7-26 Tone Sequential Configuration Tile	7 - 33
Fig. 7-27 Analyzers Tile - RF Analyzer Fields	7 - 34
Fig. 7-28 Analyzers Tile - Power Meter Fields	7 - 36
Fig. 7-29 Analyzers Tile - Modulation Fields	7 - 37
Fig. 7-30 Analyzers Tile - Audio Analyzer Fields	7 - 38
Fig. 7-31 Analyzers Tile - Noise Meters Soft Key Sub-menu	7 - 40
Fig. 7-32 Frequency List Test Tile	7 - 43
Fig. 7-33 Generators Tile - RF Generator Fields	7 - 44
Fig. 7-34 EMF and PD Indicators	7 - 45
Fig. 7-35 Modulation Generator Fields	7 - 46
Fig. 7-36 DTMF Waveform Enabled Fields	7 - 47
Fig. 7-37 AF Generator Fields	7 - 48
Fig. 7-38 DTMF Keypad Entry Soft Key Sub-menus	7 - 50

List of Figures

FIGURE	PAGE
Fig. 7-39 Harmonics and Spurious Measurements Tile	7 - 51
Fig. 7-40 Harmonics and Spurious Results	7 - 52
Fig. 7-41 IQ Gen Configuration Tile - File Data	7 - 53
Fig. 7-42 IQ Gen Selection	7 - 54
Fig. 7-43 Meters Tile - Maximized View	7 - 55
Fig. 7-44 Analog Duplex Meters Tile - SINAD Meters Selected	7 - 58
Fig. 7-45 Analog Duplex Meters Tile - Hum & Noise SNR Selected	7 - 59
Fig. 7-46 Analog Duplex Meters Tile - Zeroing Hum & Noise Meter	7 - 60
Fig. 7-47 Selecting Sensitivity Search Tile	7 - 61
Fig. 7-48 Main Sensitivity Search Tile - Maximized View	7 - 61
Fig. 7-49 Sensitivity Search Tile - Log Running	7 - 62
Fig. 7-50 View Live Data Soft Key Sub-menu	7 - 63
Fig. 7-51 Sensitivity Search - View/Post Data Tile	7 - 64
Fig. 7-52 Sensitivity Search - File Manager Tile	7 - 64
Fig. 7-53 Logged Data File	7 - 65
Fig. 7-54 Logged Data - Plot Log Soft Key Sub-menu	7 - 65
Fig. 7-55 Tone Decoding Tile	7 - 67
Fig. 7-56 Tone Type and Generator Selection	7 - 68
Fig. 7-57 Tone Remote - Modulation	7 - 69
Fig. 7-58 Tone Remote - Audio	7 - 70
Fig. 7-59 Tone Sequential - Modulation	7 - 71
Fig. 7-60 Tone Sequential - Audio	7 - 72
Fig. 7-61 Two Tone Sequential - Modulation	7 - 73
Fig. 7-62 Two Tone Sequential - Audio	7 - 74
Fig. 8-1 Accessing Audio Analyzer	8 - 1
Fig. 8-2 Audio Analyzer Tile - Maximized View	8 - 2
Fig. 8-3 Log Scaling Selected	8 - 3
Fig. 8-4 Audio Analyzer - Ref Level and Scale Settings	8 - 4
Fig. 8-5 Audio Analyzer Start and Stop Frequency Setting	8 - 4
Fig. 8-6 Audio Analyzer Trace Soft Keys	8 - 5
Fig. 8-7 Audio Analyzer - Trace Limits Enabled	8 - 7
Fig. 8-8 Audio Analyzer - Rx Bandpass Sweep	8 - 8
Fig. 8-9 Audio Analyzer - Tx Bandpass Sweep	8 - 8
Fig. 8-10 Spectrum Analyzer Tile - Tracking Generator Parameters	8 - 10
Fig. 8-11 Spectrum Analyzer - Power Between Markers Measurement	8 - 11
Fig. 8-12 Spectrum Analyzer - Occupied Bandwidth at 99%	8 - 11
Fig. 8-13 Spectrum Analyzer - Occupied Bandwidth at 75%	8 - 12
Fig. 8-14 Harmonics and Spurious Measurements Tile	8 - 13
Fig. 8-15 Harmonics and Spurious Results	8 - 14

List of Figures

FIGURE	PAGE
Fig. 8-16 Harm & Spur Limits Configuration Tile	8 - 14
Fig. 8-17 IQ Gen Configuration Tile - File Data	8 - 16
Fig. 8-18 IQ Gen Selection	8 - 17
Fig. 8-19 Selecting Sensitivity Search Tile	8 - 18
Fig. 8-20 Main Sensitivity Search Tile - Maximized View	8 - 18
Fig. 8-21 Sensitivity Search Tile - Log Running	8 - 19
Fig. 8-22 View Live Data Soft Key Sub-menu	8 - 20
Fig. 8-23 Sensitivity Search - View/Post Data Tile	8 - 21
Fig. 8-24 Sensitivity Search - File Manager Tile	8 - 21
Fig. 8-25 Logged Data File	8 - 22
Fig. 8-26 Logged Data - Plot Log Soft Key Sub-menu	8 - 22
Fig. 8-27 POCSAG Encoding Tile	8 - 24
Fig. 8-28 POCSAG Message Field States	8 - 25
Fig. 8-29 POCSAG Encoding - Sending Message	8 - 26
Fig. 8-30 POCSAG Decoding Tile	8 - 27
Fig. 8-31 Selectivity Generator Tile	8 - 29
Fig. 8-32 Selectivity Generator - Illustrated Waveform	8 - 30
Fig. 8-33 Selectivity Generator Test Setup Diagram	8 - 31
Fig. 9-1 Broadband Power, Reference Oscillator, Deviation Balance Selected	9 - 1
Fig. 9-2 Main Tile - Test Status Indicators	9 - 2
Fig. 9-3 Advanced Soft Key User Interface	9 - 3
Fig. 9-4 Cable Loss Tables Defined	9 - 4
Fig. 9-5 Specifications Tile Example	9 - 5
Fig. 9-6 Motorola ASTRO 25 Autotest Information	9 - 5
Fig. 9-7 Specification Save As Dialog Box	9 - 7
Fig. 9-8 Results Tile - Full Test Sequence	9 - 8
Fig. 9-9 Portable/Mobile UUT <50 Watts Test Setup	9 - 10
Fig. 9-10 Mobile >50 Watts Test Setup	9 - 11
Fig. 9-11 Portable UUT <50 Watts Test Setup	9 - 12
Fig. 9-12 Mobile >50 Watts Test Setup	9 - 13
Fig. 9-13 Power Alignment Test (Opt 602) Test Setup	9 - 14
Fig. 9-14 Motorola APX7000 AutoTest Test Setup	9 - 16
Fig. 9-15 EF Johnson Handheld Radio Alignment Test Setup	9 - 17
Fig. 9-16 EF Johnson Mobile Radio Alignment Test Setup	9 - 18
Fig. 9-17 BK DPHx Handheld Radio Alignment Test Setup	9 - 19
Fig. 9-18 Kenwood P25 TK-5X10G Handheld Series Radio Test/Alignment Test Setup	9 - 20
Fig. 9-19 Kenwood P25 TK-5X10G Mobile Series Low-Power Radio Test/Alignment Test Setup	9 - 21
Fig. 9-20 Kenwood P25 TK-5X10HG Mobile Series High-Power Radio Test/Alignment Test Setup	9 - 22

List of Figures

FIGURE	PAGE
Fig. 9-21 MOTOTRBO Series Handheld Radio AutoTest/Alignment Test Setup . .	9 - 23
Fig. 9-22 MOTOTRBO Series Mobile Radio AutoTest/Alignment Test Setup	9 - 24

Chapter 1 - General Information

1.1 INTRODUCTION

The 3900 Digital Radio Test Set is a portable test solution for advanced professional analog and digital radio communications.

The Test Set is designed to support field upgrades to install optional systems and features, allowing the user to expand the measurement and signaling capabilities of the unit to accommodate industry changes and advancements.

Standard instruments include a Spectrum Analyzer, Channel Analyzer and Oscilloscope.



Fig. 1-1 3920 Digital Radio Test Set

1.2 TEST SET FEATURES

The 3900 contains the following features:

- Frequency Reference input or output connection allows Test Set to use an external frequency standard or to serve as a frequency standard for other test equipment.
- Parallel measuring methods contribute to fast operation.
- Audible and visual warning system with automatic disconnection provides protection against RF input overload and RF Generator excessive reverse power.
- Full color display with a maximize - minimize tile display for customized screen configurations.
- Tone Signaling Test function to evaluate tone-activated pagers and control systems.
- Memory function to store instrument settings, test results and other data.
- USB version 1.1 memory stick/jump drive connector for transferring data to and from the Test Set's internal memory.
- Printer ports to enable screen captures and AutoTest results to be printed.
- Output from the signal analyzer at 10.7 MHz from the IF output BNC connection.
- 9 pin VGA video output connector which allows use of an external monitor.
- Bail Arm handle for multi-position bench support.

1.3 TEST SET USAGE

The Test Set can be used as free-standing test equipment or in a rack environment using one of the optional rack mount kits.

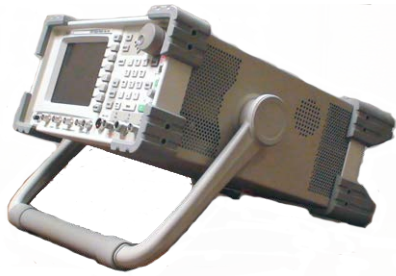

Tilted Position

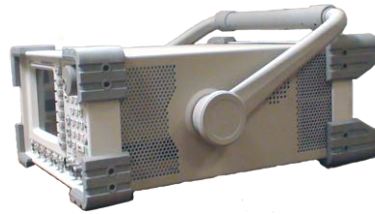

Shipping/Storage Position

1.4 OPTIONAL TEST SYSTEMS AND FUNCTIONS

The 3900 Series provides various optional test systems and functions that allow users to configure the Test Set to meet a variety of testing requirements.

Refer to Appendix F, Optional Test Systems and Functions for detailed description of options currently available for the 3900 Series.

1.5 REMOTE AND AUTOMATIC CONTROL

The Test Set may be operated remotely via an interface conforming to IEEE Std 488.1-1987. This standard defines the electrical, mechanical and low-level protocol characteristics of the bus structure, the GPIB (General Purpose Interface Bus).

Several SCPI features have been implemented in the Test Set to facilitate system integration. These features include the extended status reporting structure, the error numbering scheme, the command mnemonic derivation rules (long and short form) and many of the frequently used commands. Many of the SCPI features included in the Test Set are not defined by the SCPI standard, therefore, the Test Set is not fully compliant with SCPI (Standard Commands for Programmable Instruments) requirements. Refer to SCPI 1997 for details.

Refer to section titled Remote Tile in [Chapter 4, Test Set Utility Tiles](#) for information on configuring the Test Set for Remote Operation.

Refer to the 3900 Series Remote Programming Manual for list of valid remote commands.

Chapter 2 - Installation

2.1 INTRODUCTION

This chapter describes the following:

- Preparing the 3900 for first time use.
- Power requirements and routine safety tests and inspections.
- Interconnections to various control connectors, printer connectors and other input and output connectors.

2.2 INITIAL VISUAL INSPECTION

Visual inspections should be performed periodically depending on operating environment, maintenance and use.

2.3 INSTALLATION REQUIREMENTS

CAUTION

2.3.1 Ventilation

The 3900 is force air-cooled by three fans that draw air through vents in the sides of the case. Do not obstruct the air vents while the instrument is in use. Avoid standing the instrument on or close to other equipment that is hot.

2.3.2 Connecting to AC Power Supply

The 3900 is a Safety Class 1 test instrument which must be grounded before use. The power cord supplied with the Test Set, or an appropriate replacement, should be used to connect the Test Set to a grounded AC supply outlet. Ensure that the power cord is properly connected to the AC Power Connector on the rear panel of the Test Set prior to connecting unit to an AC supply outlet.

The 3900's PSU automatically selects the appropriate power supply range when the Test Set is connected to an AC power supply source which is within the ranges specified in Appendix B, 3900 Platform Specifications.

2.3.3 Disconnecting from AC Power Supply

The detachable AC power cord is the Test Set's disconnecting device. If the instrument is integrated into a rack or test system, an external power switch or circuit breaker may be required. The Test Set's AC Power Cord should be easily reached and accessible at all times.

2.3.4 AC Power Fuse

A 3 Amp, 250 V, Type F, 20 mm cartridge fuse (F3AL250V) is included in the unit's supply current path to the Power Supply Module. The AC Power Fuse is located in the fuse carrier located on the rear of the Test Set. Replace fuse only with fuses of the specified voltage and current ratings.

2.4 POWER REQUIREMENTS

2.4.1 Class I Power Cords (3-core)

2.4.1.A General

To connect the Test Set to a Class II (ungrounded) 2-terminal socket outlet, fit the power cord with either a 3-pin Class I plug used in conjunction with an adapter incorporating a ground wire, or fit the power cord with a Class II plug containing an integral ground wire. The ground wire must be securely fastened to ground; grounding one terminal on a 2-terminal socket does not provide adequate protection.

A 3-wire (grounded) power cord containing a molded IEC 320 connector is included with the 3900. The cable must be fitted with an approved plug which, when plugged into an appropriate 3-terminal socket outlet, grounds the case of the Test Set.

Failure to ground the Test Set or using a damaged power cord may expose the operator to hazardous voltage levels. Replacement power cords are available from VIAVI.

2.4.1.B Wire-Ended

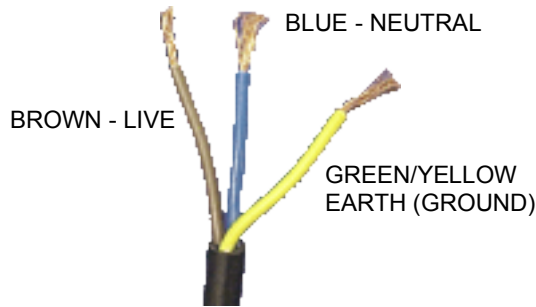

Fig. 2-1 Wire-Ended Class I Power Cord

Country	IEC 320 Plug Type
Universal	Straight through
Universal	Right angled

	North America
Line (live)	Black
Neutral	White
Ground (Earth)	Green

NOTE Color coding of the wires varies according to destination country.

2.4.1.C British

The UK lead is fitted with an ASTA approved molded plug conforming to BS 1363. A replaceable 13 A fuse conforming to BS 1362 is contained within the plug. This fuse is only designed to protect the lead assembly. Do not use the plug if the fuse cover is damaged or removed from the fuse holder.

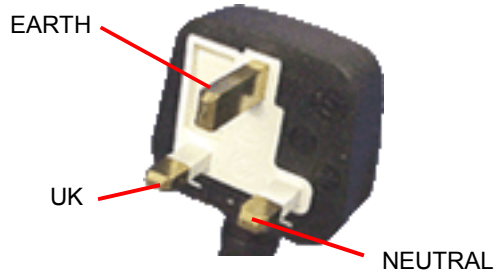

Fig. 2-2 British Class I Power Cord

Country	IEX 320 Plug Type
United Kingdom	Straight through
United Kingdom	Right angled

2.4.1.D North American

The North American lead is fitted with a NEMA 5-15P (Canadian CS22.2 No 42) plug and carries approvals from UL and CSA for use in the USA and Canada.

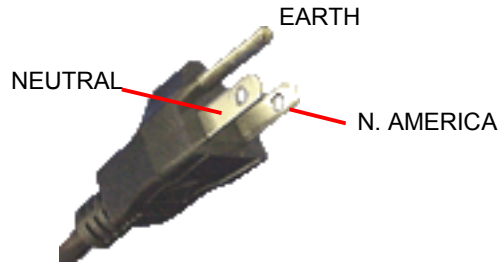

Fig. 2-3 North American Class I Power Cord

Country	IEX 320 Plug Type
North America	Straight through
North America	Right angled

2.4.1.E Continental Europe

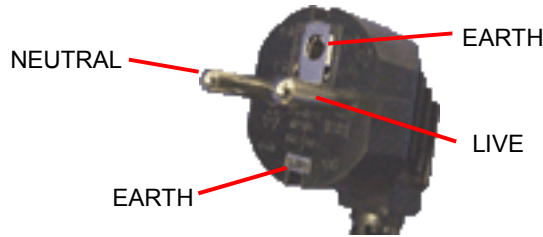

Fig. 2-4 Continental Europe Class I Power Cord

Country	IEX 320 Plug Type
Europe	Straight through
Europe	Right angled

2.4.1.E.1 English

The Continental European lead is fitted with a right angle IEC83 standard C4 plug (CEE 7/7) which allow the lead to be used in sockets with either a male earth pin (standard C 3b) or side earth clips (standard C 2b), which are commonly called the German ‘Schuko’ plug. This plug is not polarized when fitted into a Schuko socket. The lead carries approvals for use in Austria, Belgium, Finland, France, Germany, Holland, Italy, Norway and Sweden. This plug does not fit Italian standard CEI 23-16 outlets and should not be used in Denmark because a grounded connection is not established.

2.4.1.E.2 Français

Le câble d'alimentation d'Europe Continentale est muni d'un connecteur mâle à angle droit type CEI83, standard C4 (CEE 7/7), qui peut être utilisé dans une prise femelle à ergot de terre (standard C 3b) ou à clips latéraux (standard C 2b), cette dernière étant communément appelée prise “Schuko” allemande. De la même façon que les autres connecteurs de type Schuko, celui-ci n'est pas polarisé lorsqu'il s'adapte à une prise femelle Schuko. Ce câble d'alimentation est homologué en Allemagne, Autriche, Belgique, Finlande, France, Hollande, Italie, Norvège et Suède. A noter que ce connecteur n'est pas compatible avec les prises de courant italiennes au standard CEI 23-16. Ce câble ne doit pas être utilisé au Danemark à cause du défaut de connexion de masse.

2.4.1.E.3 Deutsch

Das kontinentaleuropäische Netzkabel ist mit einem rechtwinkligen Stecker nach IEC83 C4 (CEE7/7) Standard versehen, welcher sowohl in Steckdosen mit Erde-Stift (Standard C 3b) oder seitlichen Erdeklemmen, im allgemeinen “Schukosteckdose” genannt, paßt. Üblicherweise ist der Schukostecker bei Verwendung in Schukosteckdosen nicht gepolt. Dieses Netzkabel besitzt Zulassung für Österreich, Belgien, Finnland, Frankreich, Deutschland, Holland, Italien, Norwegen und Schweden.

Hinweis: Dieser Schukostecker paßt nicht in die italienischen Standardsteckdosen nach CEI 23-16 Norm. Dieses Netzkabel sollte nicht in Dänemark verwendet werden, da hier keine Erdeverbindung hergestellt wird.

2.4.1.E.4 Español

El cable de alimentación tipo Europeo Continental dispone de una clavija C4 normalizada IEC83 (CEE 7/7) que permite su utilización tanto en bases de enchufe con toma de tierra macho (tipo C 3b) o con toma de tierra mediante contactos laterales (tipo C 2b) que, en este último caso, suele denominarse "Schuko". Al igual que cualquier otra clavija tipo Schuko, las conexiones a red no están polarizadas cuando se conectan a una base tipo Schuko. El cable lleva autorización para su uso en Austria, Bélgica, Finlandia, Francia, Alemania, Holanda, Italia, Noruega y Suecia. Observe que este cable no se adapta a la norma italiana CEI 23-16. El cable no debe utilizarse en Dinamarca en el caso de no efectuarse conexión a tierra.

2.4.1.E.5 Italiano

I cavi d'alimentazione per l'Europa continentale vengono forniti terminati con una spina ad angolo retto del tipo C4 secondo lo standard IEC83 (CEE 7/7) che può essere usato in prese in cui la terra può essere fornita o tramite connettore maschio (C 3b) o tramite clips laterali (C 2b), quest'ultima comunemente detta di tipo tedesca "Schuko". Questa spina, quando collegata ad una presa Schuko, non è polarizzata.

Il cavo può essere usato in Austria, Belgio, Finlandia, Francia, Germania, Olanda, Norvegia, Svezia ed Italia. E' da notare che per l'Italia questo non risponde allo standard CEI 23-16.

Questa spina non dovrebbe invece essere usata in Danimarca in quanto non realizza il collegamento di terra.

2.5 ACCESSORY CONNECTORS

2.5.1 MIC/ACC Connector

The Microphone and Accessory connector allows a user to connect a microphone, headset, or speaker.

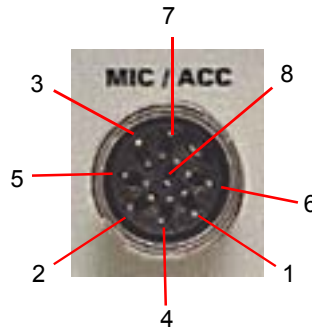

Fig. 2-5 MIC/ACC Pin Locations

MIC/ACC Connector pin functions are as follows:

Pin Number	Signal Name	Signal Type	I/O
1	MIC Switch (PTT)	TTL	Out
2	MIC Audio	Audio	In
3	Demod Audio	Audio	Out
4		No Connection	
5		2-13 Vdc	
6		No Connection	
7	MIC Switch (PTT)	TTL	In
8	GND	Instrument ground	

See also MIC/ACC Connector in Chapter 3, Test Set Operation.

See also Remote Tile in Chapter 4, Utility Tiles.

2.5.2 GPIB Connector

The GPIB/IEEE-488 Interface connector is provided for interconnection to a GPIB/IEEE-488 interface bus. Remote access is configured on the Test Set's Remote Tile.

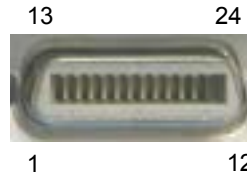

Fig. 2-6 GPIB Connector Pin Locations

GPIB Connector pin functions are as follows:

Pin Number	Function	Pin Number	Function
1	Data I/O 1	13	Data I/O 5
2	Data I/O 2	14	Data I/O 6
3	Data I/O 3	15	Data I/O 7
4	Data I/O 4	16	Data I/O 8
5	EOI	17	REN
6	DAV	18	Pair with 6
7	NRFD	19	Pair with 7
8	NDAC	20	Pair with 8
9	IFC	21	Pair with 9
10	SRQ	22	Pair with 10
11	ATN	23	Pair with 11
12	Ground Shield	24	Logic Ground

See also GPIB/IEEE-488 Interface Connection in Chapter 3, Test Set Operation.

See also Access Test Set via GPIB Connection (RCI Operation) in Chapter 4, Utility Tiles.

2.5.2.A Stacked Connectors

When stacking connectors to make multiple connections, ensure that excessive strain is not placed on the GPIB socket; strain can damage the GPIB Connector, resulting in intermittent or faulty connections.

2.5.3 RS-232 Serial Connector

The RS-232 Connector is a standard 9 way, D-type connection.

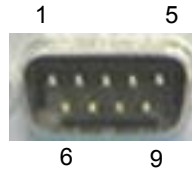

Fig. 2-7 Serial Connector Pin Locations

Serial Connector pin functions are as follows:

Pin Number	Function	Pin Number	Function
1	DCD	6	DSR
2	Rx Data In	7	RTS
3	Tx Data Out	8	CTS
4	DTR	9	RI
5	Ground		

Functions DTR on contact 4 and RTS on contact 7 are held at logic 1. When connecting the Test Set to another DTE device, such as a PC, a NULL MODEM cable is required. Hard handshaking is not implemented.

See also RS-232 Serial Connector in Chapter 3, Test Set Operation.

2.5.4 Parallel Connector

The Parallel Printer Output Connector is a standard 25 way, D-type printer connection. The Printer Configuration Tile is used to configure printer setup.



Fig. 2-8 Parallel Connector Pin Locations

Parallel Connector pin functions are as follows:

Pin Number	Function	Pin Number	Function
1	Strobe	10	ACK
2	Data 0	11	BUSY
3	Data 1	12	PE
4	Data 2	13	SLCT
5	Data 3	14	AUTOFD
6	Data 4	15	ERROR
7	Data 5	16	INIT
8	Data 6	17	SLCT IN
9	Data 7	18 to 25	Ground

See also Parallel Printer Output Connector in Chapter 3, Test Set Operation.

See also Printer Configuration Tile in Chapter 4, Utility Tiles.

2.5.5 Auxiliary IF Input

The Auxiliary IF Input Connector is reserved for future development. Do not make any connections to this connector.

2.5.6 VGA Monitor Output

The VGA Output Connector is a standard VGA style, 15 way, D-type connection that allows a VGA monitor or video projector to duplicate the Test Set's screen display.

To ensure proper operation, the VGA Monitor must be connected to the output connector before the Test Set is turned on.



Fig. 2-9 VGA Monitor Output Pin Locations

VGA Monitor Output pin functions are as follows:

Pin Number	Function	Pin Number	Function
1	Red Video	9	No Connection
2	Green Video	10	Sync Return
3	Blue Video	11	Monitor ID 0
4	Monitor ID 2	12	Monitor ID 1
5	Ground	13	Horizontal Sync
6	Red Return	14	Vertical Sync
7	Green Return	15	Monitor ID 3
8	Blue Return		

See also VGA Monitor Output Connector in Chapter 3, Test Set Operation.

See also Access Test Set via VNC Connection (GUI Operation) in Chapter 4, Utility Tiles.

2.5.7 Ethernet and USB Connectors

The Ethernet Connector is a standard Base T RJ45 connection. This connection can be used for software upgrades and for Remote operation.

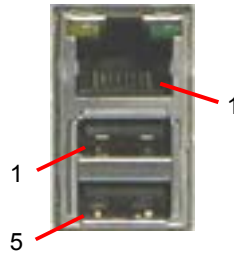

Fig. 2-10 Ethernet and USB Connector Pin Locations

Ethernet Connector pin functions are as follows:

Pin Number	Signal Type	Signal Name	I/O
1	DATA	Tx (+)	OUT
2	DATA	Tx (-)	OUT
3	DATA	Rx (+)	IN
4	DATA	Rx (-)	IN
5	GND	GND	GND
6	GND	GND	GND
7	GND	GND	GND
8	GND	GND	GND

See also Ethernet Connector in Chapter 3, Test Set Operation.

See also Access Test Set via Ethernet Connection (RCI Operation) in Chapter 4, Utility Tiles.

2.5.7.A USB Connector

The USB Connector is a twin USB standard connection. Recommended USB memory device is VIAVI PN 67325.

2.5.7.B USB Slave Connector

Connector is reserved for future development.

Pin Number	Signal Type	Signal Name	I/O
1	PWR	VCC	
2	DATA	(-) DATA	I/O
3	DATA	(+) DATA	I/O
4	PWR	GND	
5	PWR	VCC	
6	DATA	(-) DATA	I/O
7	DATA	(+) DATA	I/O
8	PWR	GND	

2.5.8 PS/2 Interface Connectors

The PS/2 Interface Connector is a standard PS/2 connection. PS/2 mouse support is not enabled at this time.

A USB mouse can be connected at the USB Connector and used as an alternative to the Front Panel Cursor Keys.

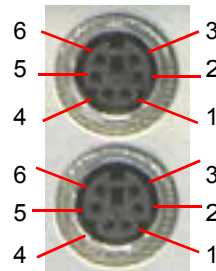

Fig. 2-11 PS/2 Connector Pin Locations

2.5.8.A PS/2 Pin-Out Connector

Pin Number	Signal Type	Signal Name	Description
1	Bi-directional	DATA	Data
2	No Connection		
3	Power	GND	GND
4	Power	+5 V	Supply Voltage
5	Bi-directional	CLK	Clock
6	No Connection		
Shell	Earth Ground		Chassis Ground

See also PS/2 Interface Connector in Chapter 3, Test Set Operation.

2.5.9 Test Connector

The Test Connector provides a 0 to 12 V, 50 mA, programmable source.

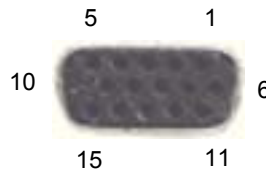

Fig. 2-12 Test Connector Pin Locations

Test Connector pin types are as follows:

Pin Number	Signal Type	Pin Number	Signal Type
1	Digital In 1	9	Serial Out
2	Digital In 2	10	Digital Out 1
3	Digital In 3	11	Digital Out 2
4	Digital In 4	12	Digital Out 3
5	Digital In 5	13	Digital Out 4
6	No Connection	14	No Connection
7	Ground	15	Ground

2.6 ROUTINE SAFETY TESTING AND INSPECTION

The following electrical tests and inspection information is provided for guidance purposes only. These tests involve the use of voltages and currents that can cause injury and should only be performed by qualified personnel familiar with ESD and electrical safety precautions.

Prior to carrying out any inspection or test procedure, disconnect all external equipment from the Test Set and disconnect the Test Set from the AC Power Supply. All tests should include the instrument's own supply lead, all covers must be fitted and the 3900 AC Power Supply Switch must be in the ON position.

Recommended tests and inspection should be carried out in the following sequence:

- Visual Inspection
- Earth (Ground) Bonding Tests
- Insulation Resistance Test

2.6.1 Earth Bonding Tests

Earth bonding tests should be performed using a 25 A (12 V maximum open circuit voltage) DC source. Tests should be limited to a maximum duration of 5 seconds and have a pass limit of 0.1 ohm after allowing for the resistance of the supply lead.

Exceeding the 5 second test duration can damage the Test Set. The tests should be carried out between the supply earth and exposed case metalwork. No attempt should be made to perform the tests on functional earths (e.g., signal carrying connector shells or screen connections) as this damages the Test Set.

2.6.2 Insulation Tests

A 500 V DC test should be applied between the protective earth connection and combined live and neutral supply connections while the 3900 AC Power Supply Switch is in the ON position. To avoid switching the live and neutral poles on the Test Set, establish the live/neutral links on the appliance tester or its connector. The test voltage should be applied for 5 seconds before taking the measurement.

VIAVI uses reinforced insulation in the construction of the 3900 and, therefore a minimum pass limit of 7 Mohm should be achieved during this test.

When a DC power adapter is provided with the equipment, the adapter must pass the 7 Mohm test limit.

VIAVI does not recommend dielectric flash testing during routine safety tests. Most portable appliance testers use AC for the dielectric strength test which can damage the supply input filter capacitors.

2.6.3 Record Maintenance

VIAVI recommends that test results be recorded and reviewed as part of each test inspection. Significant differences between previous readings and measured values should be investigated.

If any failure is detected during visual inspection or electrical tests, the equipment should be disabled and evaluated by a qualified service technician.

Safety critical components should only be replaced with comparable parts, using techniques and procedures recommended by VIAVI.

The above information is provided for guidance purposes only. VIAVI designs and manufactures its products in accordance with International Safety Standards so that when used in accordance with recommend guidelines, they represent no hazard to the operator. VIAVI reserves the right to amend the above information in the course of its continuing commitment to product safety.

2.6.4 External Cleaning

The following procedure contains routine instructions for cleaning the outside of the 3900.

- Clean front panel buttons and display face with soft lint-free cloth. If dirt is difficult to remove, dampen cloth with water and a mild liquid detergent.
- Remove grease, fungus and ground-in dirt from surfaces with soft lint-free cloth dampened (not soaked) with isopropyl alcohol.
- Remove dust and dirt from connectors with soft-bristled brush.
- Cover connectors, not in use, with suitable dust cover to prevent tarnishing of connector contacts.
- Clean cables with soft lint-free cloth.
- Paint exposed metal surface to avoid corrosion.

2.6.5 Visual Inspection

Visual inspections should be performed periodically depending on operating environment, maintenance and use.

- Verify Test Set has been installed in accordance with the instructions provided (e.g., that ventilation is adequate, supply isolators are accessible, supply wiring is adequate and properly routed).
- Ensure that AC Power Cord and supply connector(s) are in good condition.
- Verify the correct rating and type of supply fuses are used.
- Examine the stability and condition of covers and handles.
- Check the presence and condition of all warning labels and markings and supplied safety information.
- Check the wiring in re-wireable plugs and appliance connectors.
- Check the cleanliness and condition of any ventilation fan filters.
- Ensure that the AC Power Supply Switch isolates the equipment from the AC Power Supply.
- Check the supply indicator functions (if fitted).
- Any noted defects should be corrected before proceeding with the following electrical tests.

2.6.6 Carry Handle and Bench Support

The Test Set is fitted with a Bail Arm carry handle and bench support. The handle is attached to the Test Set with hubs that allow full handle rotation with 12 locking positions. To rotate the Bail Arm, stand the Test Set on the rear feet and pull both handle hubs outward, away from the case assembly. Rotate the handle and release hubs to lock handle position.

THIS PAGE INTENTIONALLY LEFT BLANK.

Chapter 3 - Test Set Operation

3.1 INTRODUCTION

New Test Sets are configured to start in the factory default setting. Unless specifically mentioned, this chapter refers to local operation of a 3900 configured with factory default settings. Before using Test Set, review power requirements and initial setup described in Chapter 2, Installation.

3.2 FRONT PANEL CONTROLS AND CONNECTORS

Refer to Numerical Reference Charts for connector cross-reference.

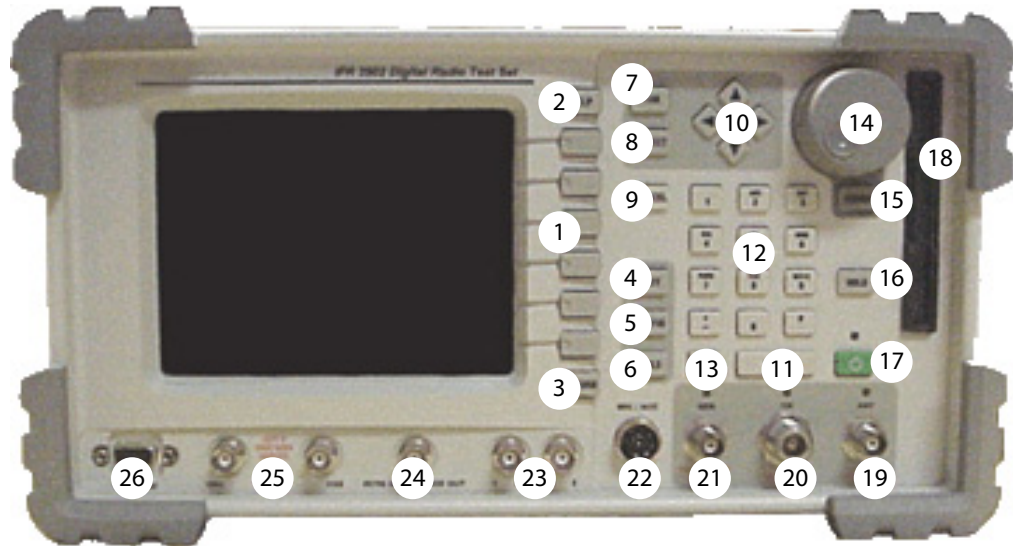

Fig. 3-1 3901/3902 Front Panel Connectors



Fig. 3-2 3920/3920B Front Panel Connectors

3.2.1. Front Panel Connector Numerical Reference Guide

Numerical Reference	Front Panel Connectors	Page
1	Soft Keys	3 - 2
2	HELP Key	3 - 2
3	Return Key	3 - 3
4	TEST Key	3 - 3
5	CONFIG Key	3 - 3
6	UTILS Key	3 - 3
7	TAB Key	3 - 3
8	SELECT Key	3 - 3
9	CANCEL Key	3 - 3
10	Cursor Keys	3 - 3
11	ENTER Key	3 - 3
12	Data Entry Input Keys	3 - 4
13	BKSP (Backspace) Key	3 - 4
14	Rotary Control Knob	3 - 4
15	ASSIGN Key	3 - 5
16	Display HOLD Key	3 - 5
17	On/Standby Key	3 - 5
18	3.5 inch Floppy Disk Drive (3901/3902)	3 - 5
18	DMM (Digital Multimeter) (3920)	3 - 5
19	ANT (Antenna) Connector	3 - 5
20	T/R Connector	3 - 6
21	GEN (Generator) Connector	3 - 6
22	MIC/ACC Connector	3 - 6
23	Audio 1/2 In Connectors	3 - 6
24	FCTN GEN/DEMODO Connector	3 - 6
25	Scope CH1/CH2 Connectors	3 - 6
26	Test Connector	3 - 6
27	USB Connector	3 - 6

3.2.1.A Soft Keys

The 3900 contains six soft keys that are active when a label is displayed on the screen to the left of the soft key. The text on the label identifies the key, the outline and background color provide information about the purpose, state and type of action the key initiates.

3.2.1.B HELP Key

The HELP Key accesses operational description for Test Set fields and functions.

3.2.1.C RETURN Key

The Return Key closes the displayed soft key sub-menu, which is indicated by a “return” indicator at the bottom of the soft key area.

The Return Key also changes the display to minimized view when one of the tiles is maximized. This feature is available when any Test tile other than the Spectrum Analyzer is maximized.

3.2.1.D TEST Key

The TEST Key selects the 3900 TEST mode of operation and accesses the TEST floating menu.

Refer to the Modes of Operation section in this chapter for additional information.

3.2.1.E CONFIG Key

The CONFIG Key accesses the Test Set’s System and Configuration menu.

Refer to the Modes of Operation section in this chapter for additional information.

3.2.1.F UTILS Key

The UTILS Key accesses the 3900 UTILS (Utilities) functions.

Refer to the Modes of Operation section in this chapter for additional information.

3.2.1.F.1 Mouse Option

When a mouse is connected to the Test Set USB Connector, pressing the right mouse button displays a pop-up menu that contains entries for the TEST, CONFIG (Configuration) and UTILS (Utilities) functions. Selecting the function from the menu has the same effect as pressing the key on the front panel.

3.2.1.G TAB Key

The TAB Key is used to navigate display tiles and to activate the TAB floating menu when operating in Test Mode.

3.2.1.H SELECT Key

The SELECT Key selects highlighted data fields and menus and also activates entered data.

3.2.1.I CANCEL Key

The CANCEL Key voids any un-entered changes made using the data entry keys.

3.2.1.J Cursor Keys

The Cursor Keys are used to navigate display tiles, data fields and drop-down menus. Cursor Keys can also be used to enter data.

3.2.1.K ENTER Key

The ENTER Key enables the values that have been entered using the data input keys. New values are not effective until they have been enabled.

3.2.1.L Data Entry Input Keys

3.2.1.L.1 Numeric/Alphabetic Keys

Data entry fields are used for setting numeric and text values. Numeric values are changed by entering the data using the Data Entry Input Keys or by adjusting the value using the Cursor Keys or Rotary Control Knob. Text is entered using the Data Entry Input Keys or an external keyboard.

3.2.1.L.2 Signage Keys

- (minus)
- . (decimal point)
- * (star/asterik)
- # (hash)

3.2.1.M BKSP (BACKSPACE) Key

BKSP (Backspace) deletes the character or digit to the left of the position indicator when a numeric entry box or a text box is selected for editing.

The characters assigned to each Numeric/Alphabetic key are as follows: repeating sequences are shaded gray.

Key	1st	2nd	3rd	4th	5th	6th	7th	8th	9th
1	-	'	()	1	-	'	()
ABC/2	a	b	c	A	B	C	2	a	b
DEF/3	d	e	f	D	E	F	3	d	e
GHI/4	g	h	i	G	H	I	4	g	h
JKL/5	j	k	l	J	K	L	5	j	k
MNO/6	m	n	o	M	N	O	6	m	n
PQRS/7	p	q	r	s	P	Q	R	S	7
TUV/8	t	u	v	T	U	V	8	t	u
WXYZ/9	w	x	y	z	W	X	Y	Z	9
+/-	-	+	=	-	&	!	-	+	=
0	(space)	O	(space)	O	(space)	O	(space)	0	(space)
#/.	(.)	#	@	&	[]	(.)	#	@

3.2.1.N Rotary Control Knob

The Rotary Control Knob can be used to navigate between fields of a selected Tile, select data from drop-down menus, edit numerical content in data fields, select a data field or menu item and to adjust various Test Set settings.

3.2.1.N.1 Navigating Fields

The Rotary Control Knob can be used to move from field to field on a selected display tile. When the desired field is reached, press the SELECT Key to edit the field.

3.2.1.N.2 Editing Numeric Entry Boxes

When a numeric entry box is selected for editing, turning the rotary control increases or decreases the numeric setting. Adjusting the level of significant digits accelerates the response of the Rotary Control Knob. Pressing the Rotary Control Knob activates a defined value.

3.2.1.N.3 Menu Item Selection

When a floating menu or a drop-down menu from a combination settings box is displayed, turning the Rotary Control Knob scrolls through the active list. Pressing the Rotary Control Knob activates a value and selects a menu item.

3.2.1.N.4 Assigned Functions

The Rotary Control Knob changes settings of functions that are enabled when the ASSIGN Key is pressed.

3.2.1.O ASSIGN Key

The ASSIGN Key allows functions such as loudspeaker volume and audio routing, squelch level, and display brightness to be adjusted using the Rotary Control Knob.

3.2.1.P Display HOLD Key

The HOLD Key freezes the display to allow the user to capture, print and save the current screen display.

3.2.1.Q On/Standby Key

The Power Supply On/Standby key is referred to as the On/Standby key. The Power Supply On/Standby Key is used to power the Test Set on and off.

- The On/Standby Key LED is not illuminated when the AC Power Supply Switch is OFF.
- The On/Standby LED is ORANGE when the AC Power Supply Switch is in the ON position and the Test Set is in STANDBY mode.
- The On/Standby LED turns BLUE when the Test Set is booting up.
- The On/Standby LED is GREEN when the Test Set is ready for operation.

3.2.1.R 3.5 inch Floppy Disk Drive

The 3901/3902 3.5 inch Floppy Disk Drive provides an interface for transferring data, settings and captured display files to and from the test set. Data transfers are managed through the UTILS, File Management Tile.

3.2.1.R.1 Powering Up

Before powering up the Test Set, check that the floppy disk drive does not contain a disk. If there is a disk in the drive at power up the Test Set may display irrelevant error messages. If this occurs, remove the disk and restart the Test Set.

3.2.1.S Digital Multimeter

The Digital Multimeter (DMM) Option (390XOPT035) provides users with the ability to perform resistance measurements and AC and DC current and voltage measurements.

3.2.1.T ANT (Antenna) Connector

The ANT Connector is a 50 ohm TNC input, providing maximum sensitivity input to the Test Set RF Analyzer.

CAUTION

THE RATED MAXIMUM INPUT LEVEL FOR THE ANT CONNECTOR IS +10 DBM.

REFER TO 3900 PLATFORM SPECIFICATIONS FOR ADDITIONAL INFORMATION.

3.2.1.U T/R Connector

The T/R Connector is a 50 ohm N type, combined (Duplexed) connector that provides an RF Gen output connection and an RF analyzer input and broadband power meter connection.

CAUTION

THE MAXIMUM RATED INPUT POWER LEVEL FOR THE T/R CONNECTOR IS 125 W.

REFER TO 3900 PLATFORM SPECIFICATIONS FOR ADDITIONAL INFORMATION.

3.2.1.V GEN (Generator) Connector

The RF Gen output is a 50 ohm TNC output, providing the maximum RF output level from the RF Gen.

The RF GEN Connector is reverse power protected to a level of +10 dBm.

3.2.1.W MIC/ACC Connector

The Microphone and Accessory connector allows a user to connect a microphone, headset, or speaker.

See also MIC/ACC Connector Pin Out in Chapter 2.

3.2.1.X Audio 1 and 2 IN Connectors

AUDIO IN 1 and 2 are the primary AF input and external modulation input connectors. The Connectors can be configured as high impedance, unbalanced or 600 ohm balanced.

3.2.1.Y FCTN GEN/DEMODO Connector

(Function Generator and Demodulated Signal Output)

The FCTN/GEN Demod Connector is the primary AF GEN output.

3.2.1.Z Scope CH1/CH2 Connectors

The Scope CH1 and CH2 connectors are the dedicated inputs to the dual-trace oscilloscope, providing a maximum input rating of 100 V_{peak}.

3.2.1.AA Test Connector

The Test Connector provides a 0 to 12 V, 50 mA, programmable source.

CAUTION

DO NOT CONNECT A VGA MONITOR TO THIS CONNECTOR.

See also Test Connector Pin Out in Chapter 2.

3.2.1.AB USB Connector

The Front Panel USB Connector is a USB standard connection that allows connection of USB 1.1 devices (e.g. a USB memory stick or Network connectors). Recommended USB memory device is VIAVI PN 7110-1100-400. The Front Panel USB Connector is only found on the 3920 Test Set.

3.3 REAR PANEL CONTROLS AND CONNECTORS

Refer to Numerical Reference Charts for connector cross-reference.

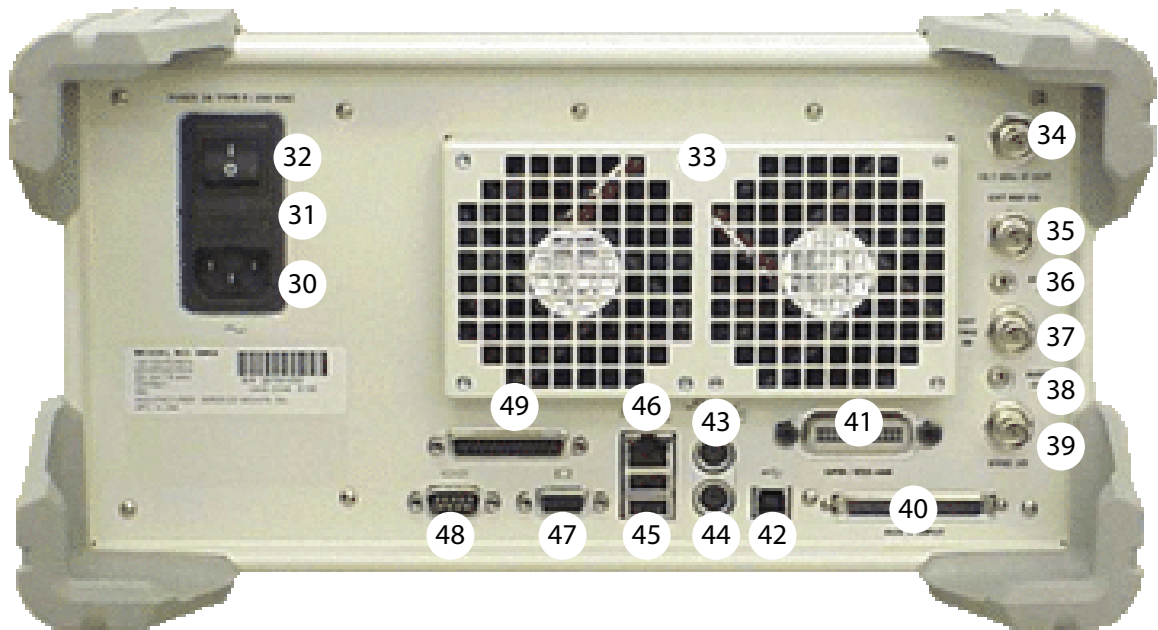

Fig. 3-3 3900 Series Rear Panel Connectors

3.3.1. Rear Panel Connector Numerical Reference Guide

Numerical Reference	Rear Panel Connectors	Page
30	AC Power Connector	3 - 8
31	AC Power Fuse	3 - 8
32	AC Power Supply Switch	3 - 8
33	Rear Cooling Outlets	3 - 8
34	IF Output Signal Connector	3 - 8
35	Ext Ref I/O External Interface	3 - 8
36	Audio Input Connector	3 - 8
37	External Trigger Source Input	3 - 9
38	Audio Output Connector	3 - 9
39	Sync Signal I/O Connector	3 - 9
40	Auxiliary IF Input Connector	3 - 9
41	GPIB/IEEE-488 Interface Connector	3 - 9
42	Standard USB Client Connector	3 - 9
43	PS/2 Mouse Interface Connector	3 - 9
44	Keyboard Interface Connector	3 - 9
45	USB Connector	3 - 9
46	Ethernet Connector	3 - 10
47	VGA Monitor Output Connector	3 - 10
48	RS-232 Serial Connector	3 - 10
49	Parallel Printer Output Connector	3 - 10

3.3.1.A AC Power Connector

The AC Power Connector accepts an IEC 320 connector. Refer to 3900 Platform Specifications for the required supply voltage, frequency and power consumption specifications.

3.3.1.B AC Power Fuse

The AC Fuses are accessed from the rear panel by removing the fuse cover located above the AC Power.

Refer to Appendix C, Fuse Replacement Procedure for instructions on replacing AC Power Fuse.

3.3.1.C AC Power Supply Switch

The AC Power Supply Switch isolates the 3900 from the AC power supply.

The AC Power Supply Switch should not be used for powering down the Test Set because all settings and test results are lost.

The On/Standby Key should be used for routine power down of unit because it initiates a power-down procedure, saving all current settings and test results.

Refer to sections titled Powering Test Set On and Powering Test Set Down in Chapter 3 for additional information.

3.3.1.D Rear Cooling Outlets

The Rear Fan Vents provide air circulation to the Test Set. Improper ventilation may cause the Test Set to overheat and may damage internal components.

3.3.1.E IF Output Signal Connector

The IF Output Signal is available at this BNC connector. The 10.7 MHz IF Output is the RF signal received and down-converted by the Test Set RF Analyzer.

The output level is -10 dBm typical at 10.7 MHz (50 Ohm nominal).

NOTE

The 10.7 MHz IF OUT signal is spectrally inverted. An RF signal received by the Test Set, down-converted to 10.7 MHz, then output on this socket has the property that a frequency increase or a phase advance at RF is output as a frequency reduction or phase retardation at IF. Take this into account if using this output for work with any type of FSK/PSK signaling.

3.3.1.F Ext Ref I/O External Interface

The External Reference I/O Connector is a BNC connection used to connect the Test Set to an external frequency standard, or to output the internal frequency standard from the Test Set to other equipment.

Refer to section titled Frequency Reference Tile in Chapter 4 for information on proper Test Set configuration.

3.3.1.G Audio Input Connector

The Audio Input Connector is internally connected and ready for future development. Do not make any external connection to this connector.

3.3.1.H External Trigger Signal Input Connector

The External Trigger Signal Input is the external trigger input for the Oscilloscope. This BNC connection has an Input impedance 10 k ohm.

3.3.1.I Audio Output Connector

The Audio Output Connector is internally connected and ready for future development. Do not make any external connection to this connector.

3.3.1.J Synchronization Signal Input or Output Connector

The Synchronization Signal Input/Output Connector is a BNC connection that is used with the TETRA Base Station Test System for base station receivers generating a sync output signal.

3.3.1.K Auxiliary IF Input Connector

The Auxiliary IF Input Connector is reserved for future development. Do not make any connections to this connector.

Refer to Auxiliary IF Input Pin Out in Chapter 2 for additional information.

3.3.1.L GPIB/IEEE-488 Interface Connection

The GPIB/IEEE-488 Interface connector is provided for interconnection to a GPIB/IEEE-488 interface bus. Remote access is configured on the Test Set's Remote Tile.

Refer to section titled Remote Tile in Chapter 4 for information on configuring the Test Set for GPIB operation.

Refer to GPIB Connector Pin Out in Chapter 2 for additional information.

3.3.1.M Standard USB Client Connector

The Standard USB connector is reserved for future development.

3.3.1.N PS/2 Interface Connector

The PS/2 Interface Connector is a standard PS/2 connection. PS/2 mouse support is not enabled at this time.

A USB mouse can be connected at the USB Connector and used as an alternative to the Front Panel Cursor Keys.

Refer to PS/2 Interface Connectors Pin Out in Chapter 2 for additional information.

3.3.1.O Keyboard Interface Connector

The Keyboard Interface Connector is a standard PS/2 connection that supports use of a standard PS/2 keyboard. This connector is only on the 3901/3902 models.

Refer to section titled Keyboard & Mouse Tile in Chapter 4 for keyboard configuration information.

3.3.1.P USB Connector

The Rear Panel USB connector is a double USB standard connection that allows connection of USB 1.1 devices (e.g. a USB memory stick or USB Mouse or Keyboard).

Refer to Ethernet and USB Connectors Pin Out in Chapter 2 for additional information.

3.3.1.Q Ethernet Connector

The Ethernet Connector is a standard Base T RJ45 connection. This connection can be used for software upgrades and for Remote operation.

Refer to section titled Remote Tile in Chapter 4 for information on configuring the Test Set for Ethernet operation.

Refer to Ethernet and USB Connectors Pin Out in Chapter 2 for additional information.

3.3.1.R VGA Monitor Output Connector

The VGA Output Connector is a standard VGA style, 15 way, D-type connection that allows a VGA monitor or video projector to duplicate the Test Set's screen display.

To ensure proper operation, the VGA Monitor must be connected to the output connector before the Test Set is turned on.

Refer to VGA Monitor Output Pin Out in Chapter 2 for additional information.

3.3.1.S RS-232 Serial Connector

The RS-232 Connector is a standard 9 way, D-type connection. Refer to RS-232 Serial Connector Pin Out in Chapter 2 for additional information.

3.3.1.T Parallel Printer Output Connector

The Parallel Printer Output Connector is a standard 25 way, D-type printer connection.

The Printer Configuration Tile is used to configure printer setup.

Refer to section titled Printer Configuration Tile in Chapter 4 for additional information.

Refer to Parallel Connector Pin Out in Chapter 2 for additional information.

3.4 TURNING TEST SET ON/OFF

3.4.1. Powering Test Set On

To power on the Test Set:

STEP	PROCEDURE
------	-----------

1. Connect AC Power Cord to rear panel AC Power Supply Connector.
2. Connect AC Power Cord to grounded AC Power Supply.
3. Turn AC Power Switch to ON position.
4. Press On/Standby Power Key to power on Test Set.

The default screen shown below is displayed when the unit is first powered on or after Factory Defaults have been restored. If the Test Set has been used, the unit loads content based to the selected Startup Option (refer to Startup Options Tile).

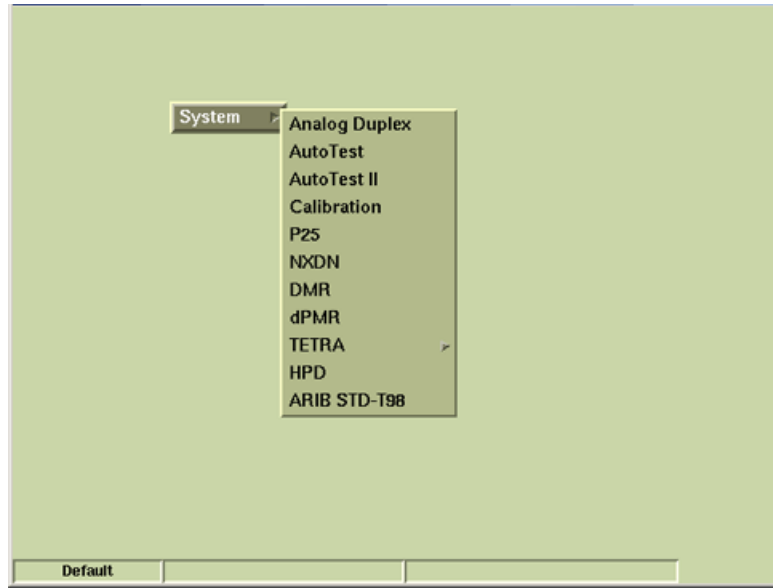

Fig. 3-4 Factory Default Tile

NOTE

System menu contents vary according to the options installed in the Test Set.

3.4.2. Powering Test Set Down

The Test Set should always be powered down using the On/Standby Key. The On/Standby Key initiates a power-down sequence that stores all current settings and results in the Test Set's internal memory. When the Test Set is powered down using the AC Power Supply Switch ("hard shutdown"), all current settings are lost and unit reverts to last saved state the next time it is powered on.

If the Test Set is to be left in an unused state for an extended period of time, press the On/Standby Key to power down the Test Set. After the unit has stored settings and is in the OFF state, isolate the Test Set by switching the AC Power Supply Switch to the OFF position. When the Test Set is next powered on it is restored to the selected Startup state (refer to Startup Options Tile).

3.4.2.A Power Down Test Set:

STEP	PROCEDURE
1.	Press the On-Standby Key to power down Test Set.
2.	At prompt, select Yes to continue power down process.

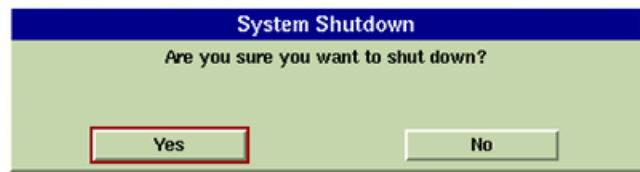

Fig. 3-5 System Shut-Down Prompt Dialog Box

3. Wait while Test Set stores settings.
4. When unit shuts down, turn AC Power Switch to OFF to disconnect from AC Power Supply.

3.4.2.B Floppy Disk Drive

When powering down, check that the floppy disk drive does not contain a disk. If there is a disk in the drive at power up the Test Set may display irrelevant error messages. If this occurs remove the disk and restart the Test Set.

3.5 TEST SET FACTORY DEFAULT SETTINGS

3.5.1. Initial Start-up in Factory Default State

STEP	PROCEDURE
1.	Connect the Test Set to the AC Power Supply.
2.	Turn the AC Power Supply Switch on the rear panel to the ON position. The LED above the On/Standby Key should change to RED.
3.	Press the On/Standby Key. Verify that no error messages appear on the display when the Test Set powers on. After a few seconds, the Factory Default Tile is displayed.
4.	Using the Cursor Keys (or a mouse), select one of the systems from the System menu.
5.	Verify no error messages appear while the selected system loads.
6.	Test Set should now operate in accordance with the 3900 Series Operation Manual and applicable option manual(s).

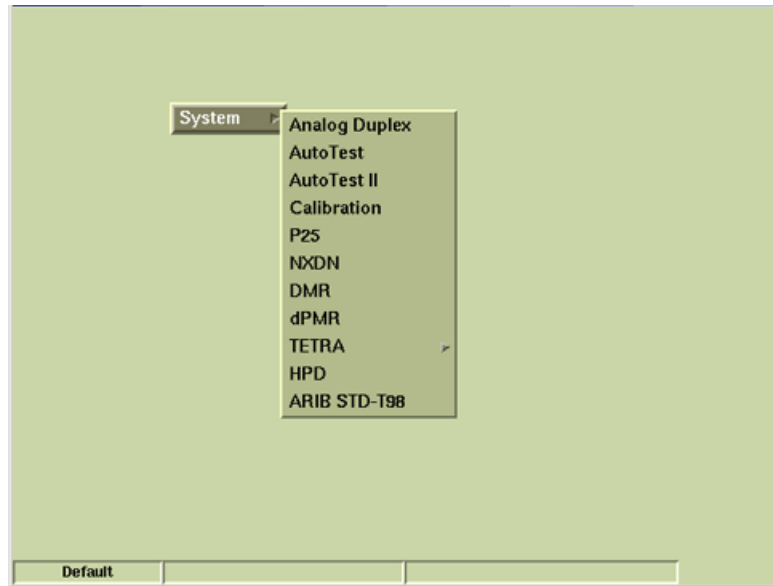

Fig. 3-6 Factory Default Display Tile

3.5.2. Reboot in Factory Default State

Read complete procedure before proceeding. This procedure applies to Test Sets running Software Version 1.7.2 or later.

To Reboot Test Set in Factory Default State:

STEP	PROCEDURE
1.	Connect the Test Set to the AC Power Supply.
2.	Turn the AC Power Supply Switch on the rear panel to the ON position. The LED above the On/Standby Key should change to RED.
3.	Press the On/Standby Key. Test Set proceeds through power on sequence.
4.	A blue screen with a white "X" is displayed as shown in Fig. 3-7.



Fig. 3-7 Power On Blue Screen "X"

5. Press the CANCEL Key immediately when the screen background changes from blue to a gray-green color.
6. Wait while Test Set prepares to load the System Default configuration files. This process takes 15-30 seconds.
7. A "Loading Defaults" message is displayed during remainder of power-on sequence. Test Set displays the Factory Default Tile when the power-on sequence is completed.

3.5.3. Default Restore Options

The Test Set provides the user with several options for restoring factory defaults.

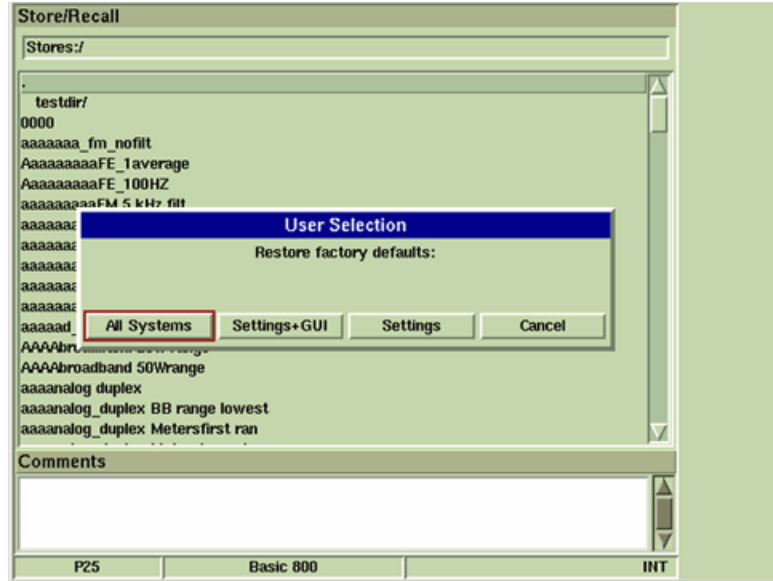

Fig. 3-8 Restore Factory Defaults - Restore Selections

3.5.3.A All Systems

Restores GUI and data fields in all Test Systems to factory default settings. Test Set reloads the last selected operating system after default settings have been restored.

3.5.3.B Settings + GUI

Restores GUI and data fields of current operating system to factory default state. Last selected operating system does not need to be reloaded.

3.5.3.C Settings

Restores data fields of current operating system to factory default state. Last selected operating system does not need to be reloaded.

3.6 MODES OF OPERATION

The Test Set has three modes of operation: TEST Mode, CONFIG (Configuration) Mode and UTILS (Utilities) Mode.

- TEST Mode accesses system measurement tiles, which are referred to as Test Tiles;
- CONFIG (Configuration) Mode accesses Configuration (Config) Tiles which are used to define test parameters for the selected system;
- UTILS (Utilities) Mode accesses Utility (Utils) Tiles which configure platform operating parameters and functions.

3.6.1. TEST Mode

The Test Set must be in TEST Mode to access TEST Tiles via the user interface. Available Test functions varies based on the selected operating system and the options installed in the Test Set. Test Tile functions are described in detail under Tile headings.

3.6.1.A Accessing Test Systems

An operating system is selected from the System/Configuration menu. The operating systems that are available depend on the options (if any) that are installed in the Test Set.

STEP	PROCEDURE
------	-----------

1. Press CONFIG Key once or twice to display System/Configuration floating menu.
2. Select System from floating menu to open System sub-menu.
3. Select desired operating system and press ENTER Soft Key.

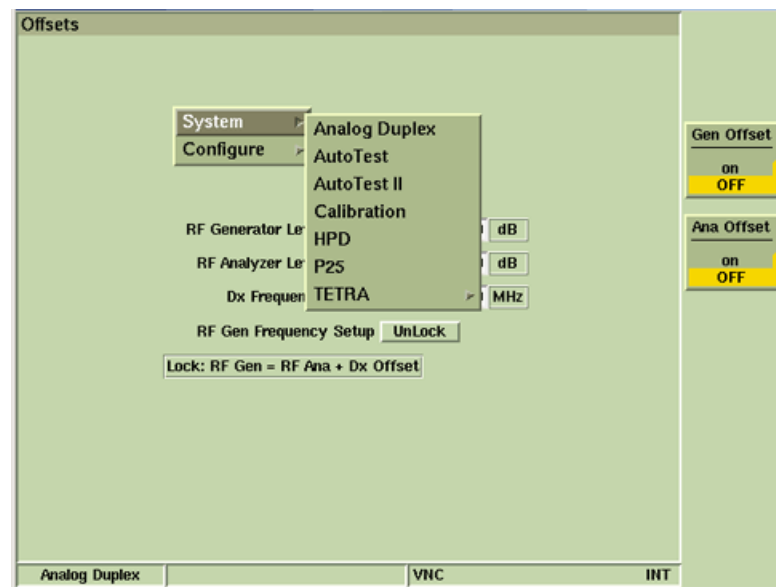

Fig. 3-9 System/Configuration Floating Menu

3.6.2. CONFIG (Configuration) Mode

Configuration Tiles contain parameters that must be configured for test operation, but also contain optional parameters that allow the user to customize test measurements. The type of Configuration Tiles available depends on the selected operating system and the options installed in the Test Set. Configuration Tile functionality is consistent from system to system for similar Configuration Tiles.

Fig. 3-10 shows the Configuration menu for the Analog Duplex System, with the Offsets Configuration Tile highlighted. When the SELECT Key is pressed, the Analog Duplex Offsets Configuration Tile is displayed.

3.6.2.A Accessing Configuration Tiles

Configuration Tiles contain parameters that must be configured for test operation, but also contain optional parameters that allow the user to customize test measurements. The Configuration Tile menu is accessed by pressing the CONFIG Key twice when operating in TEST or UTILS Mode, and once, if CONFIG Mode is already selected.

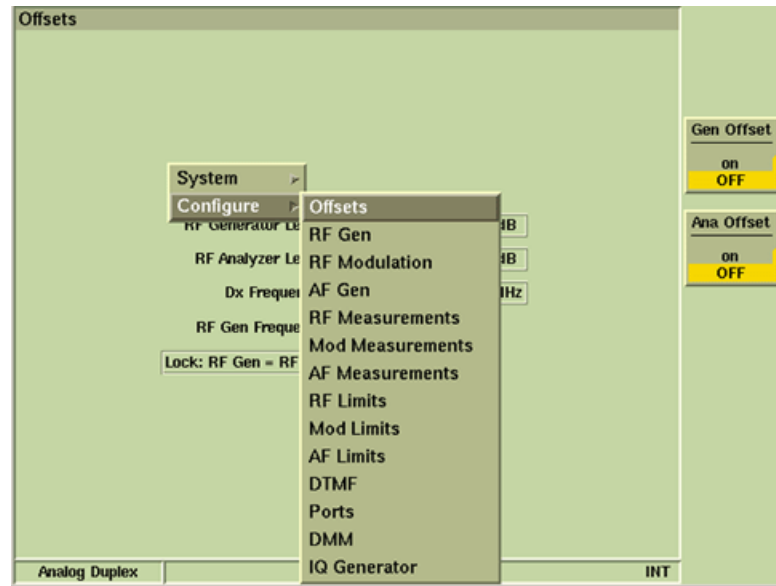

Fig. 3-10 Analog Duplex Configuration Floating Menu

3.6.3. UTILS (Utilities) Mode

The Utilities function provides access to general Test Set functions. The parameters defined on the Utility Tiles apply to all operating systems.

3.6.3.A Accessing Utility Tiles

The Utility Tile Menu is accessed by pressing the UTILS Key twice when operating in TEST or CONFIG Mode. If Utilities Mode is already selected, press the UTILS Key once to open the Utilities Menu. The Utility Tiles are described in detail in Chapter 4, Test Set Utility Tiles.

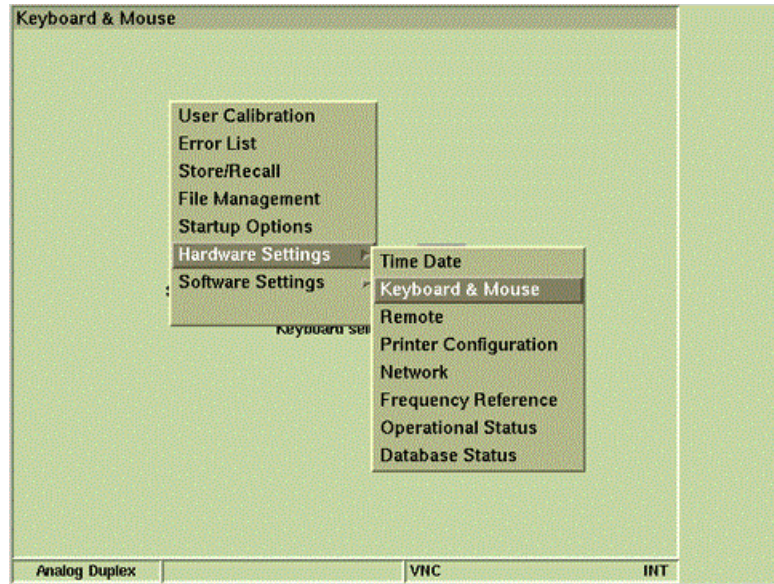

Fig. 3-11 UTILS Floating Menu - Hardware Settings Selected

3.7 DISPLAY LAYOUT

Display layout is defined by the current operating system and shows either a single tile of fixed size, or a tile or group of tiles that can be minimized or maximized. The area on the right of the display shows any soft keys applicable to the active tile. Analog Duplex System Tiles are provided as examples.

System Tiles consist of the title bar, which identifies the selected tile, a view icon which indicates maximized/minimized view and a drop-down menu to select from available tiles. The type of tiles that can be enabled depend on the selected operating system, the tile location, and the options installed in the Test Set.

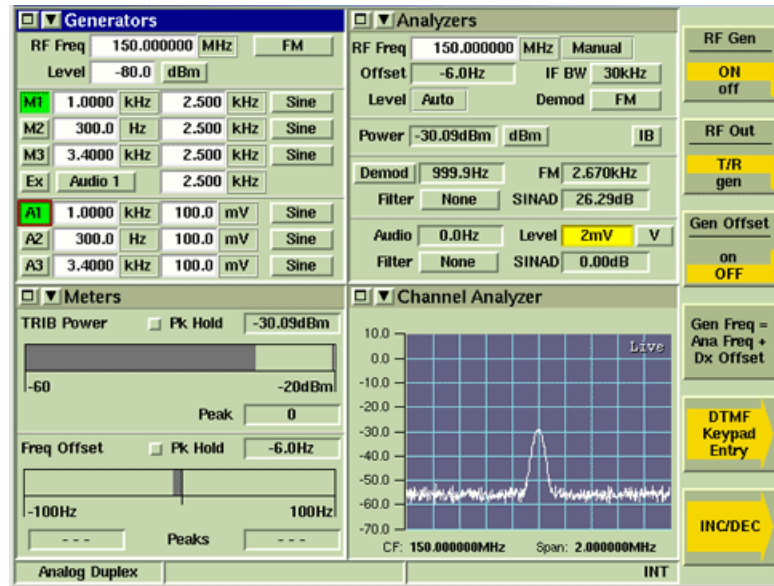

Fig. 3-12 Analog Duplex System Display - Minimized View

3.7.1. Display Tile Status Bar

All 3900 display tiles have a Status Bar located at the bottom. The Status Bar displays various information depending on the operational state of the unit.

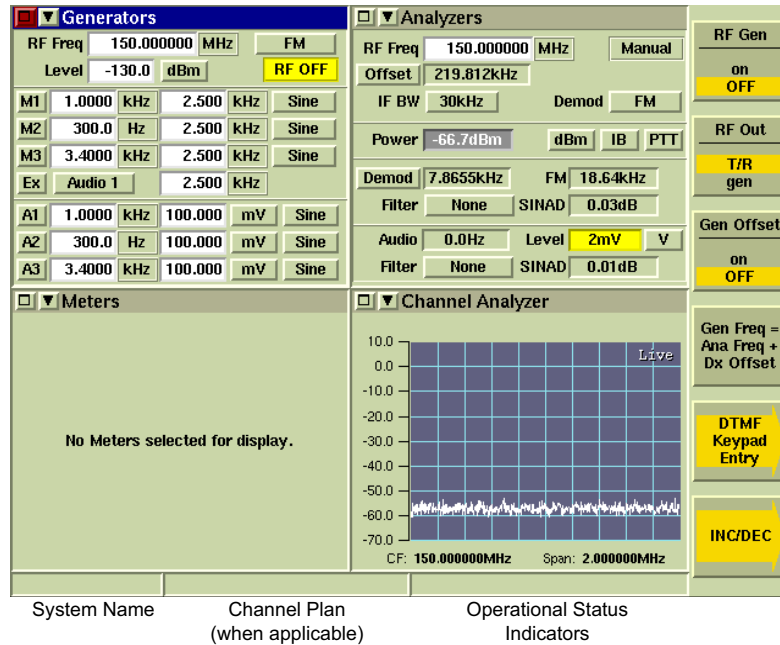

Fig. 3-13 Status Bar Fields

The example in Fig. 3-14 shows the Test Set operating with the Analog Duplex System loaded, the RF Generator is OFF and the Frequency Reference set to Internal.

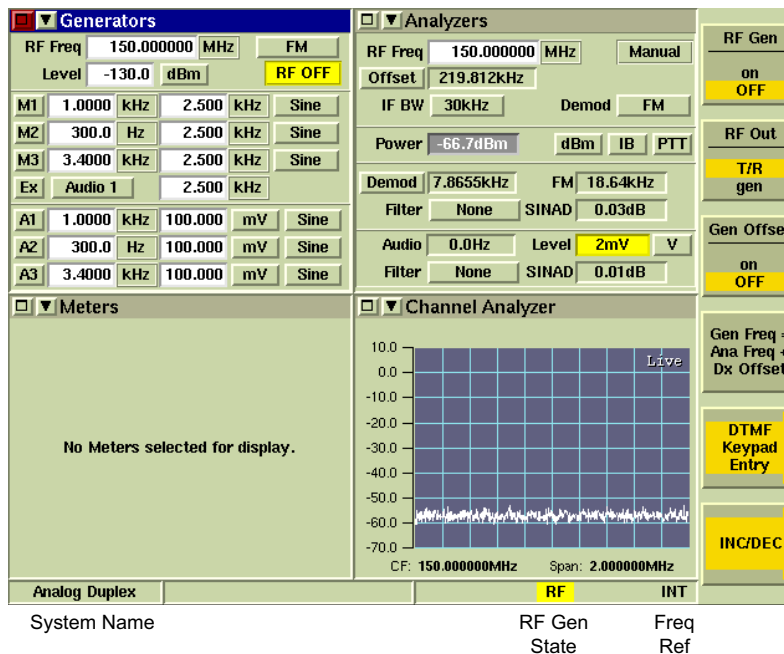

Fig. 3-14 Status Bar Content Diagram

3.7.1.A Status Bar Content

3.7.1.A.1 System Name

The System Name identifies the operating system currently selected.

3.7.1.A.2 Channel/System Plan

Some of the optional 3900 Systems support the use of Channel Plans or System Plans. In these cases the selected Channel Plan or System Plan name is displayed in this area. Fig. 3-15 shows an example in which the P25 System is loaded and a Basic 800 Channel Plan is selected.

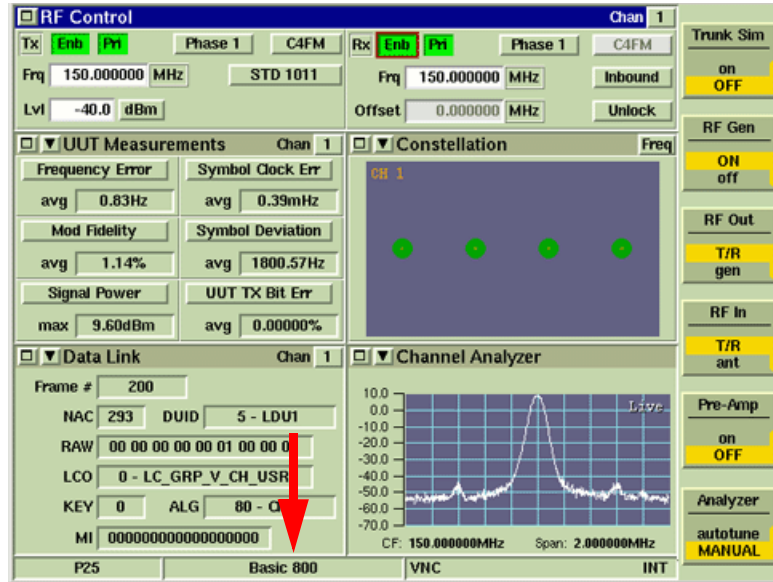

Fig. 3-15 P25 Optional System - Channel Plan Field

3.7.1.A.3 Operational Status Indicators

The following indicators notify the user of different conditions or operational settings.

AUT	Indicates the Test Set is operating in AutoTest II mode.
LCK	Indicates the Test Set is currently being controlled remotely by a GPIB connection.
EXT	Indicates the Test Set 10 MHz Frequency Reference is set to External and the Test Set is connected to a valid external reference.
EXT	Indicates the Test Set 10 MHz Frequency Reference is set to External and the Test Set is not connected (locked) to a valid external reference.
INT	Indicates the Test Set is set to use the Internal 10 MHz Frequency Reference.
RF	Indicates RF Generator is OFF.
CAL	Indicates User Calibration is required.
VNC	Indicates the Test Set is being accessed via a VNC Viewer application.
HOT	HOT with a red background indicates the Test Set's internal temperature has exceeded 75° C and needs to be reduced immediately.
HOT	HOT with a yellow background indicates the Test Set's internal temperature has exceeded 70° C and needs to be reduced immediately.

3.7.2. Maximized and Minimized Views

Selecting the Maximize/Minimize icon on a Tile title bar maximizes and minimizes the selected Tile. Test Tiles can be displayed in maximized or minimized view. The Spectrum Analyzer, Utils and Config Tiles always occupy the entire display.

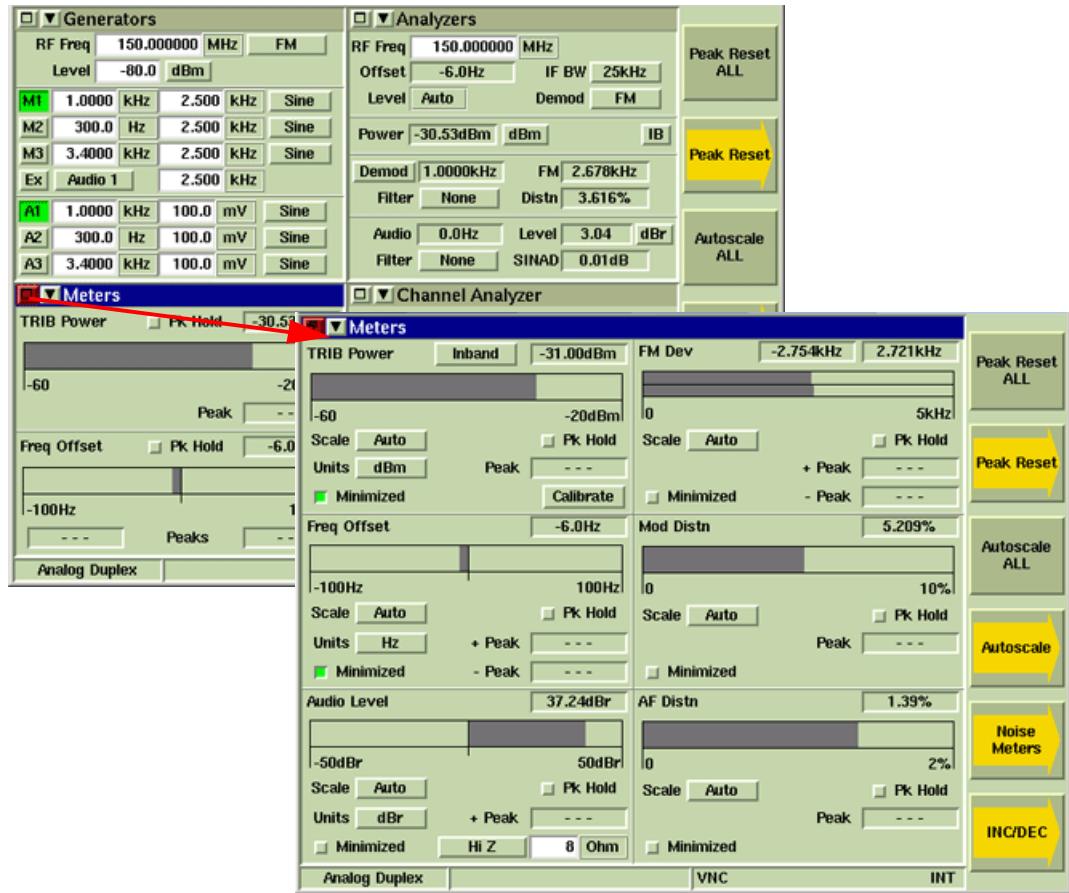

Fig. 3-16 Minimized - Maximized Viewing Options

NOTE When a display Tile is maximized, pressing the TAB Key opens a floating menu that lists the Test Tiles that are currently active in minimized view. Selecting a function from the TAB floating menu displays the Tile in maximized view. This is a quick access tool that eliminates the need to minimize the current tile in order to maximize one of the other selected tiles.

3.7.3. Navigating Display Tiles

The TAB Key on the front panel keyboard is used to navigate display tiles when in minimized view. Each key press moves focus to the next minimized display tile. The title bar changes blue to indicate focus.

When a tile is selected, fields are navigated using the directional Cursor Keys or the Rotary Control Knob.

The 3900 supports the use of an external USB Keyboard and Mouse. The Keyboard and Mouse can also be used to navigate and select tiles and display fields. Refer to section titled Keyboard and Mouse Tile in Chapter 4 for information on Keyboard and Mouse configuration.

3.7.4. Floating Menus

Floating menus are displayed by using the TEST, CONFIG, TAB and UTILS Key, or by right clicking with a mouse on the display field. The floating menu associated with the current function opens when one of these actions is performed. For example, if the CONFIG Key is pressed while the Test Tiles are displayed, the last viewed Configuration Tile opens.

When a display Tile is maximized, pressing the TAB Key opens a floating menu that lists the Test Tiles that are currently active in minimized view. Selecting a function from the TAB floating menu displays the Tile in maximized view. The first example below shows a maximized view of the Channel Analyzer Tile with the TAB floating menu that lists the Tiles that are active when the Tile is minimized.

The Cursor Keys are used to navigate menu items, both vertically and horizontally. The Rotary Control Knob can be used to navigate menus vertically. When a menu is highlighted, press the SELECT Key or Rotary Control Knob to enable the selected item.

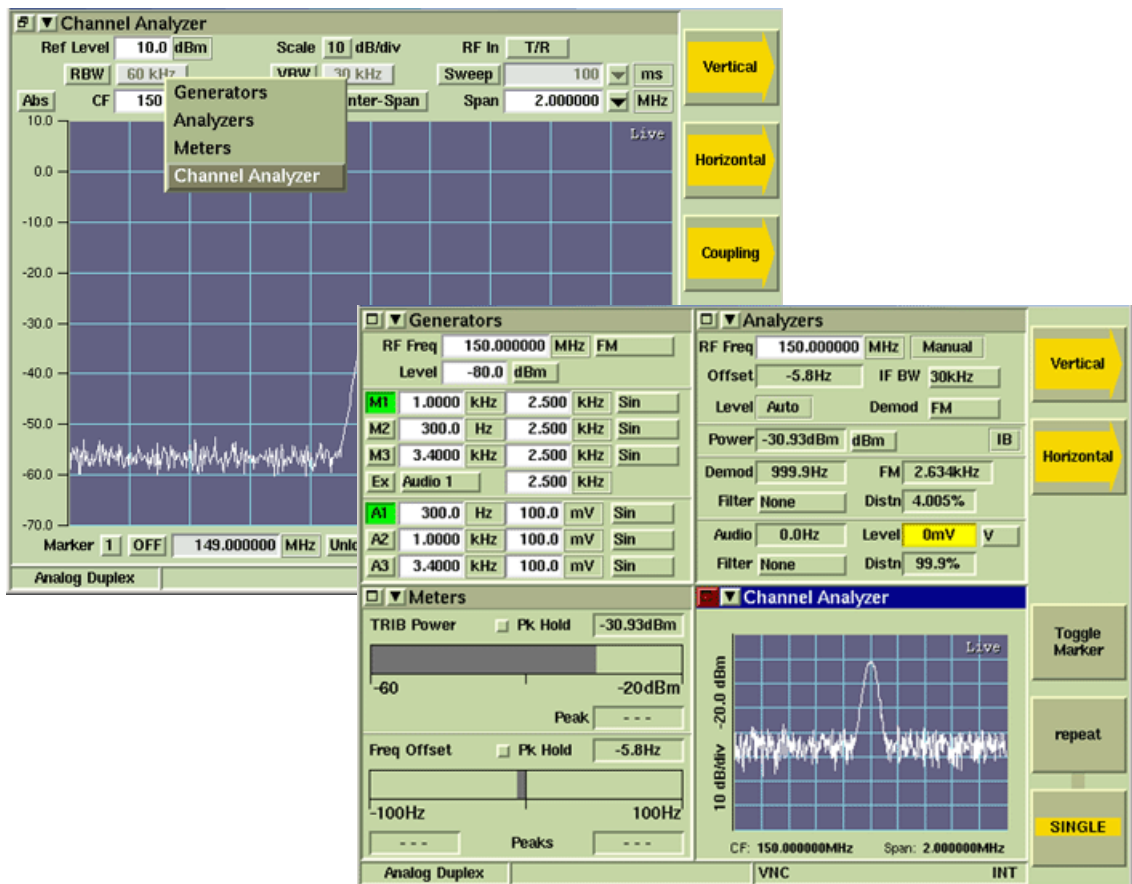

Fig. 3-17 Channel Analyzer Maximized - TAB Floating Menu of Active Tiles

3.8 DISPLAY COMPONENTS

3900 display tiles consist of the following types of interface components:

3.8.1. Drop-down Menus





The Cursor Keys or Rotary Control Knob are used to navigate to drop-down menus. The ENTER Key, SELECT Key and Rotary Control Knob are used to enable a highlighted menu item.

3.8.2. Data Entry Fields

Data entry fields are used for setting fluctuating values. The value is changed using any of the following methods:

- Data entry fields are used for setting numeric and text values. Numeric values are changed by entering the data using the Data Entry Input Keys or by adjusting the value using the Cursor Keys or Rotary Control Knob. Text is entered using the Data Entry Input Keys or an external keyboard.

To change the displayed value:

1.	Navigate to the box to be edited.	
2.	Select field. Box background changes from white to gold and text changes to black on a white background.	
3.	Enter new value using keypad or rotary knob.	
4.	Press ENTER, or if applicable, a soft key terminator (i.e., unit of measurement) to enter the value.	

3.8.2.A Selecting and Adjusting Digits

The number of significant digits to be incremented or decremented can be selected by user. Pressing the < or > key increases or decreases the number of digits selected, one digit per press. Only selected digits are changed. When the new value is correct, press the ENTER Key.



All digits selected will be changed



Only highlighted digits will be changed

Fig. 3-18 Numeric Entry - Selected Edit States

3.8.2.B Data Fields Background Color

The background color of the data field provides information relating to the state of the measurement and whether or not limits have been enabled.

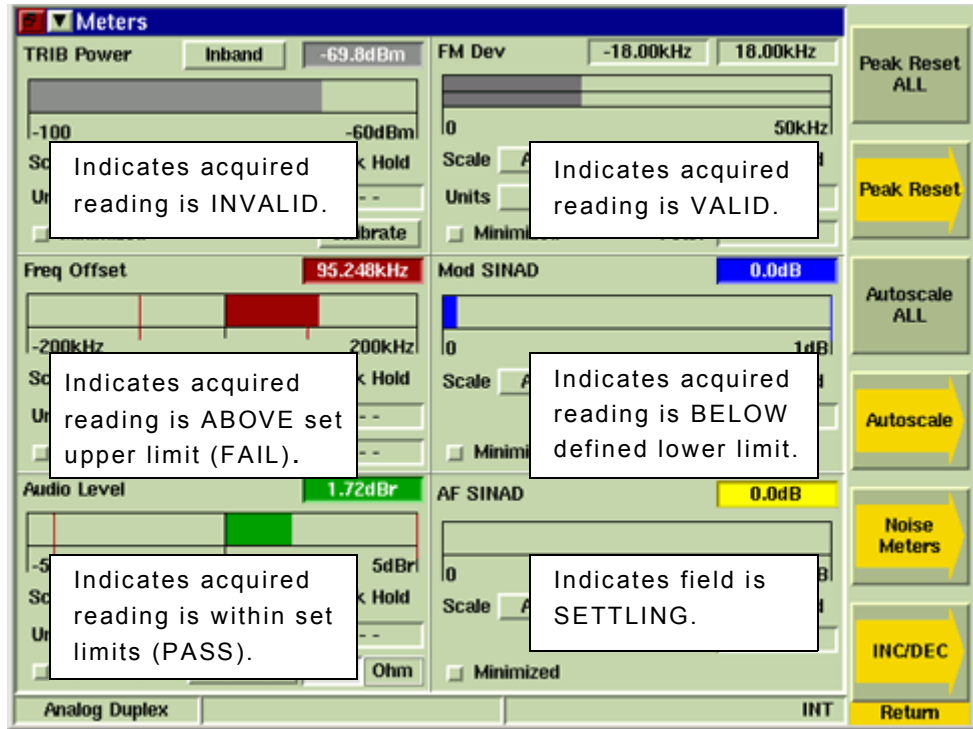

Fig. 3-19 Data Field Background Colors

3.8.2.C Pass or Fail Indicators

When the results of a test have no single value, such as Digital Radio burst profiles, the result is shown simply as Pass or Fail with a GREEN or RED background respectively.



Fig. 3-20 Pass/Fail Indicators

3.8.2.D Numeric Output Field

The annotated illustration below provides an example of a numeric output field on a TETRA MS System Tile. In this example, the measurement title is shown to the left of the numeric output field. The measurement value and the units of measurement are displayed inside the field.

When test limits have been set, an alarm symbol '!' appears to the right of the field when a measurement is outside the set limits.

A measurement value that is within specified limits is shown in white on a GREEN ground.

A measurement value that is above an upper set limit is shown in white on a RED ground, with an alarm symbol '!' shown to the right of the field.

A measurement value that is below a set lower limit is shown in white on a BLUE ground, with an alarm symbol '!' shown to the right of the field.

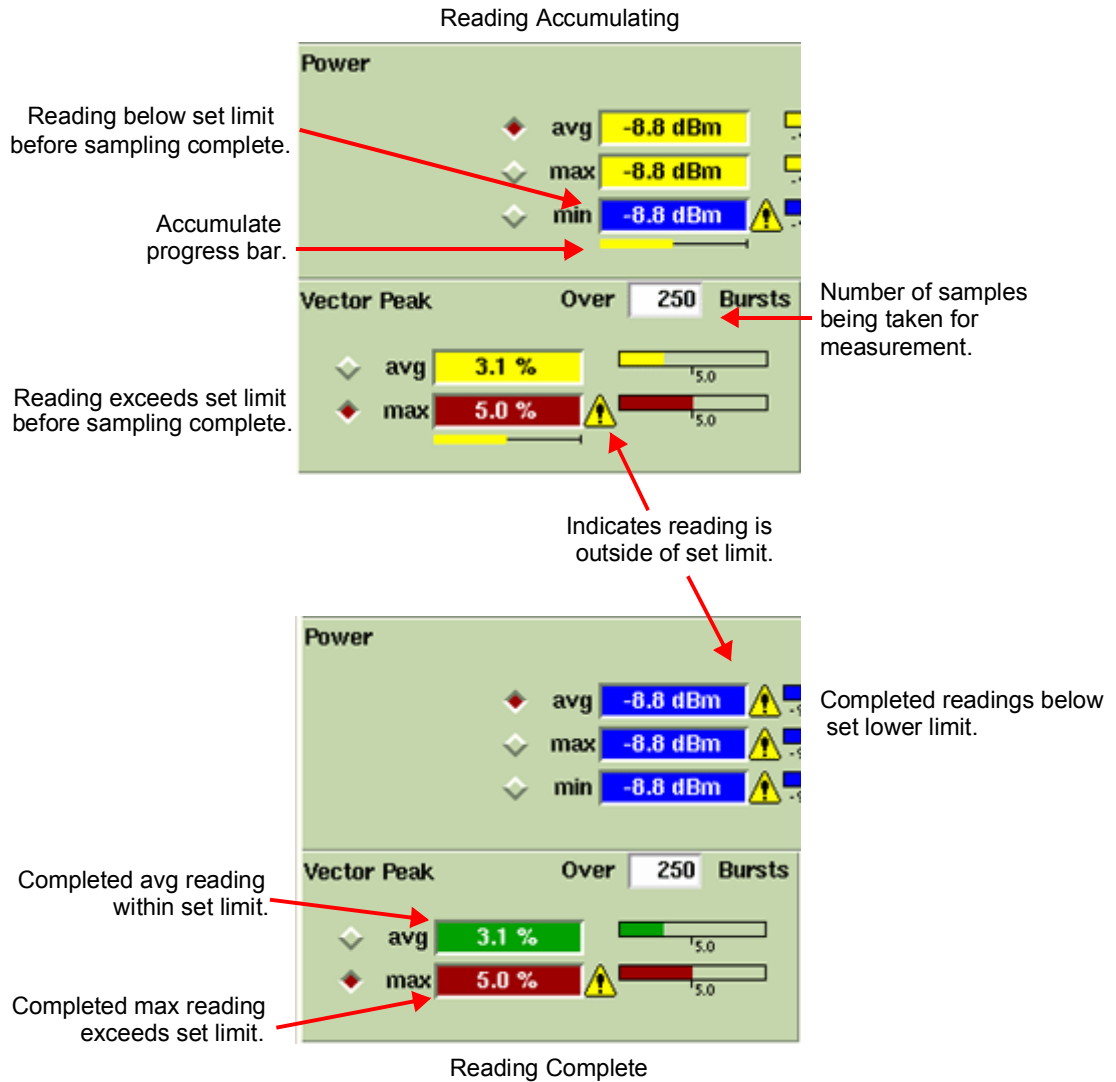

Fig. 3-21 Numeric Output and Limit Settings Readouts

A progress bar is shown below the results during data accumulation. For some measurements a bar graph also shows the result relative to the pass or fail limit or to the upper and lower limits as appropriate. A radio button is displayed next to some measurements so the measurement can be selected for display when the Tile is minimized.

3.8.3. Tick Boxes

Tick boxes are used to enable or disable various parametric options. When a tick appears in the box the option is enabled, if the box is empty it is disabled. The state is changed by focusing on the box and pressing the SELECT Key, or by clicking on the tick box with a mouse.

An example is the Analog Duplex Generators Tile, where Tick boxes are used to enable the required Modulation and Audio Generators. The options are Mod Generators 1, 2 and 3, the External Modulation Input and AF 1, 2 and 3. The selection is made by focusing on the button and pressing the SELECT Key.

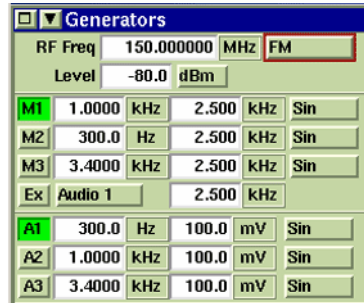

Fig. 3-22 Tick Buttons - Enable/Disable Mod Generators

3.8.4. Option Buttons

Option buttons select from a one of two possible states. For example, the Analog Duplex Meters Tile, contains an option button to set the Power measurement function to Inband or Broadband. To change the current state set of an option button, focus on the button and press the SELECT Key.

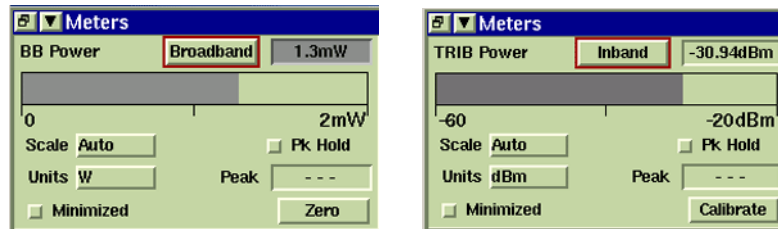

Fig. 3-23 Option (Toggle) Buttons

3.8.5. Radio Buttons

Radio buttons select one option from two or more available options, such as measurement results on a Tile. The examples below show where Radio Buttons are used to select the result (e.g. Average, Max, Min) that is to be displayed when the Tile is minimized.

The selection is made by highlighting the button and pressing the SELECT Key or clicking on the button if using the Mouse Option.



Fig. 3-24 Radio Buttons - Measurement Results Selection

3.8.6. Soft Keys

There are six soft keys located on the front panel of the 3900. A soft key is active only when a label is shown adjacent to it. The text on the label identifies the soft key, while the outline and background color of the key provide information about the purpose, state and type of action the soft key initiates.

3.8.6.A Action Soft Keys

Action keys initiate immediate actions when pressed.

	<p>For example, the Peak Reset ALL Soft Key resets peak values for all measurements on the associated screen.</p>
---	---

3.8.6.B Next Level Soft Keys

Next Level soft keys have an arrow shaped gold background. Pressing one of these types of soft keys leads to a soft key sub-menu. In some cases there is more than one sub-menu level.

	<p>Pressing this soft key displays a sub-menu of related soft keys. In this example, the soft key sub-menu relates to the RF Output Frequency incremental change value.</p>
---	---

3.8.6.C Return Soft Key

	<p>The RETURN prompt appears at the bottom of the soft key area when a sub-menu choice of soft keys is displayed. This prompt is to remind users to use the RETURN Soft Key to move back to the previous menu level.</p>
---	--

3.8.6.D Toggle Soft Keys

Toggle Soft Keys offer a choice of two, three or four options.

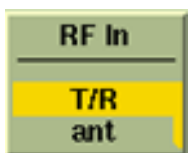
	<p>For example, the RF Gen Soft Key offers the option of ON or OFF. In this example the RF Gen is OFF; pressing the RF Gen Soft Key turns the RF Gen ON.</p>
---	--

3.8.6.E Grouped Soft Keys

Some soft keys are grouped together and function interdependently. A dark vertical bar between two soft keys indicates that they are linked. When one of a pair of linked soft keys is selected the text on the selected soft key appears capitalized and the text background of the selected key changes to a gold bar.

The soft keys in the following are linked:

3.8.6.E.1 Example A

	<p>As shown here, the SINGLE Soft Key is active, indicated by the title shown in upper case with a gold background stripe. In the particular application, the action to make a single measurement for the selected function.</p>
---	--

3.8.6.E.2 Example B

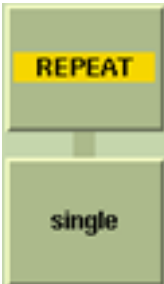
	<p>As shown here, the REPEAT Soft Key is active, indicated by the title shown in upper case with a gold background stripe. In the particular application, the action to repeat a measurement continues until terminated by pressing the Single soft key. The REPEAT Soft Key then reverts to the inactive, standby state as shown in Example A.</p>
--	---

3.9 LIMITS

3900 Test Systems contain a variety of Configuration Tiles to allow the user to define and enable upper and lower limit pass/fail parameters. The display is configured to color-code meter results to easily identify whether or not measurements are within an expected range.

- **RED** indicates a measurement has exceeded the defined upper limit value.
- **GREEN** indicates a measurement is within defined upper and lower limit values.
- **BLUE** indicates a measurement is below the defined lower limit value.

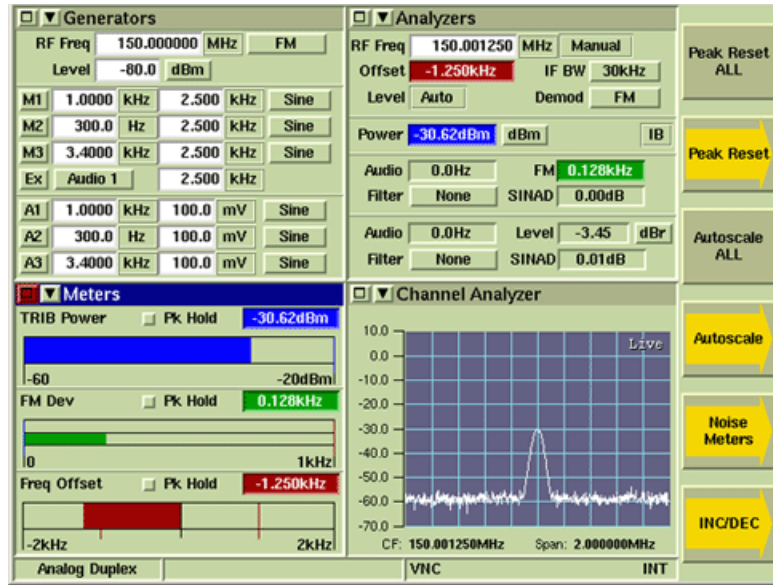

Fig. 3-25 Analog Duplex - Limits Enabled

3.9.1. Upper Limits

The UPPER LIMIT function sets a maximum acceptable reading for a specific measurement. When a measured level exceeds the enabled UPPER LIMIT, the Meter Bar and reading background on the Measurement Tiles turns RED.

When readings are within enabled Upper and Lower limits, the Meter Bar and reading background on the Measurement Tiles turns GREEN.

An Upper Limit value must be greater than the value defined in the Lower Limit field, even if the Lower Limit is not enabled.

For example, if the T/R Inband Power Upper and Lower Limit values on the RF Limits Configuration Tile are both 0.0 dBm (default values), to set T/R Inband Power Upper Limit value to -75 dBm:

STEP	PROCEDURE
1.	Set T/R Inband Lower Limit Value to a value less than -75 dBm, for this example use -100 dBm.
2.	Set T/R Inband Upper Limit Value to -75 dBm.

3.9.2. Lower Limit

When a measured level drops below the enabled LOWER LIMIT, the Meter Bar and reading background of the Measurement Tiles turns BLUE.

When readings are within enabled Upper and Lower limits, the Meter Bar and reading background on the Measurement Tiles turns GREEN.

A Lower Limit value must be less than the value defined in the Upper Limit field, even if the Upper Limit is not enabled.

For example, if the T/R Inband Power Upper and Lower Limit values on the RF Limits Configuration Tile are both 0.0 dBm (default values), to set T/R Inband Power Lower Limit value to 5.0 dBm:

STEP	PROCEDURE
1.	Set T/R Inband Upper Limit Value to a value greater than 5.0 dBm, for this example use 10.0 dBm.
2.	Set T/R Inband Lower Limit Value to 5.0 dBm.

3.10 OFFSETS

3900 Test Systems contain various Offsets that allow the user to compensate for the use of external equipment such as an attenuator. When an Offset is enabled, an indicator is displayed next to the corresponding field on various test tiles.

This symbol indicates when an offset is enabled for a particular parameter.

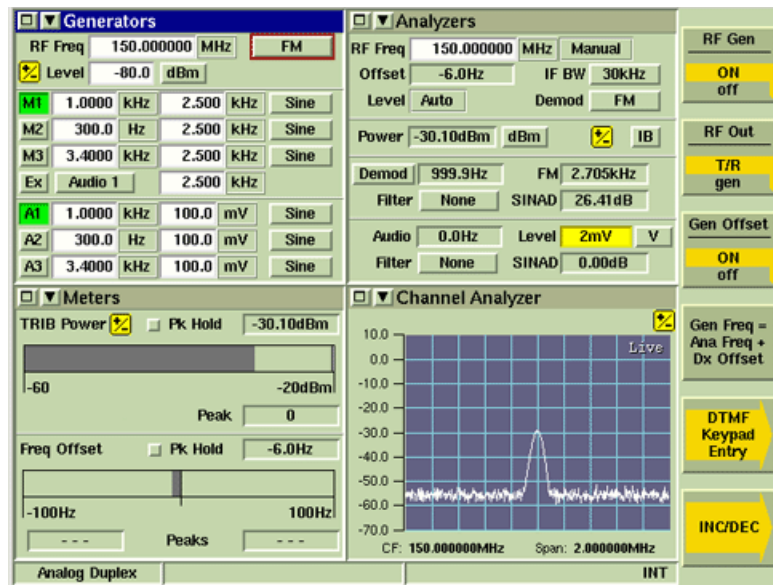

Fig. 3-26 Generator and Analyzer Offset Indicators

3.11 TEST CONFIGURATIONS AND SETUPS

The 3900 is suitable for performing radio system measurements on high performance equipment in research and development environments as well as in production and maintenance facilities. The Test Set supports one and two port duplex test configurations. The illustration below shows equipment setup for basic test scenarios. Refer to [Installation](#), for power requirements and control system information and peripheral equipment connections. The picture below shows an example of a typical test setup.

3.11.1. Digital Radio System

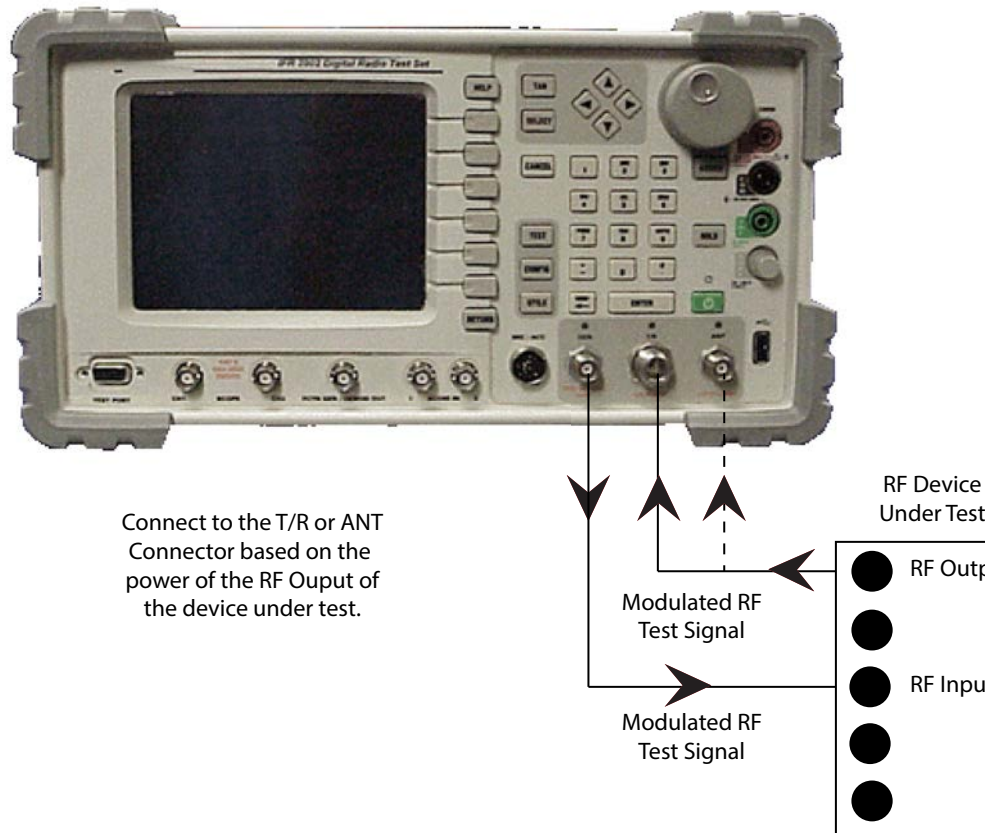

Fig. 3-27 Basic Test Setup

To test a 'Stand alone' receiver or transmitter, use the RF IN/OUT soft key(s) to select the Connector best suited to the specification of the equipment under test. The desired RF input and output connectors are selected from the Test System. For transmitter testing, the RF Gen output may need to be disabled.

There are four possible arrangements described in this section.

3.11.2. RF Input and Output Connectors

The routing of signals within the Test Set to and from the RF input and output connectors is controlled from the selected Test System. There is an LED above each connector that indicates when a connector has been selected; the LED does not indicate when the connector is ON.

Good quality, correctly fitted cables should be used to establish RF output connections. Worn connectors and damaged or kinked cables may cause high levels of reflected power, resulting in misleading results and possible damage to the transmitter.

Refer to 3900 Platform Specifications for additional information.

3.11.2.A Audible and Visual Overload Warning

If the RF Signal applied to the ANT (Antenna) Connector exceeds the safe maximum level, an audible and visual warning is triggered. The overload warning is also triggered if excessive reverse power is applied to the GEN (Generator) Connector. The Overload Warning is reset on the User Calibration Tile and Operational Status Tile .

CAUTION

IF THE AUDIBLE WARNING TRIGGERS, REDUCE POWER IMMEDIATELY. DO NOT POWER DOWN THE TEST SET AS THIS DOES NOT REMOVE THE OVERLOAD POWER FROM THE CONNECTION.

WARNING

DO NOT DISCONNECT THE RF CABLE FROM THE TEST SET AS THIS MAY CAUSE BURNS TO THE HANDS.

3.11.3. One Port Duplex

The One Port Duplex arrangement uses the T/R Connector for RF input and RF output. This arrangement is typically used for testing mobile radios using a single direct connection to the unit under test.

This arrangement can also be used for over-the-air testing when only a single antenna is available, or for testing Base stations that use a combined Rx/Tx antenna system.

RF Out = T/R
RF In = T/R



Fig. 3-28 One Port Duplex Test Setup

3.11.4. Two Port Duplex

There are three types of Two Port Duplex setups which can be used for measuring RF Gen output and RF Analyzer input.

3.11.4.A GEN/ANT

Selecting the GEN Connector for RF Out and the ANT Connector for RF Input provides the highest level of RF Gen Output and the most sensitive RF Analyzer input.

The ANT Connector is typically used as the Input connector for “over-the-air” testing with separate antennas.



Fig. 3-29 GEN/ANT Two Port Duplex Test Setup

3.11.4.B GEN/TR

Selecting the GEN Connector for RF Out and T/R Connector for RF Input provides the highest level of RF Gen Output and accepts the highest level of RF Analyzer Input.

The T/R Connector should be selected as the RF Input connector when connecting the Test Set directly to UUT via RF Cable.

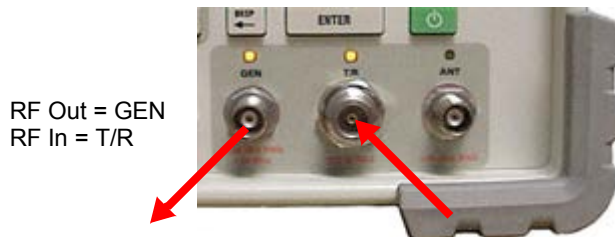

Fig. 3-30 GEN/TR Two Port Duplex Test Setup

3.11.4.C TR/ANT

Selecting the T/R Connector for RF Output and the ANT Connector for RF Input provides the lowest level of RF Gen output and the most sensitive RF Analyzer Input.

The ANT Connector is typically used as the Input connector for “over-the-air” testing.



Fig. 3-31 TR/ANT Two Port Duplex Test Setup

Chapter 4 - Test Set Utility Tiles

4.1 INTRODUCTION

The Utilities function provides access to general Test Set functions. The parameters defined on the Utility Tiles apply to all operating systems.

This section provides a functional description of the Utility Tiles and also provides information on their use and application.

4.2 ACCESSING UTILITY TILES

The Utility Tile Menu is accessed by pressing the UTILS Key twice when operating in TEST or CONFIG Mode. If Utilities Mode is already selected, press the UTILS Key once to open the Utilities Menu.

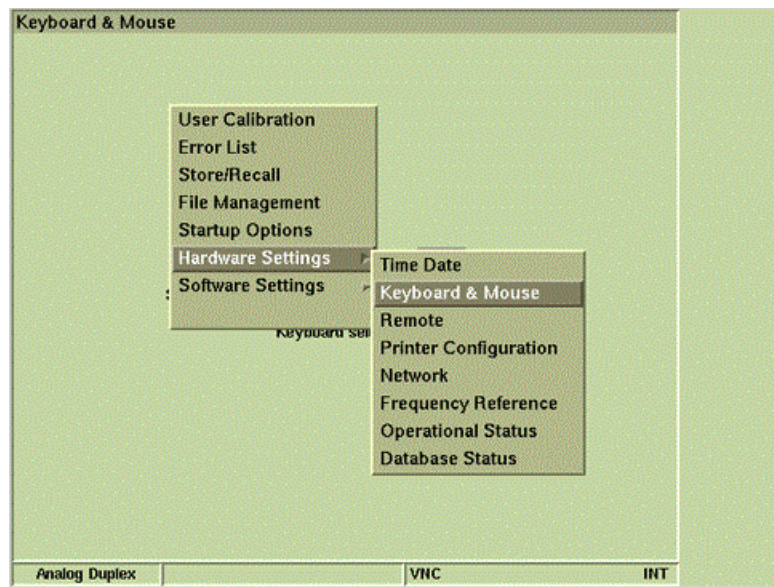

Figure 4 - 1 Utility Tile Menu

4.3 DATABASE STATUS TILE

The Database Status Tile provides users with the ability to maintain 3900 database files. The Test Set runs a pass/fail status check when the Database Status Tile is selected and when the Check Data Base Soft Key is pressed. The Database Status Tile also displays the most recent calibration date.



Fig. 4-2 Database Status Tile

4.3.1. Soft Key Definitions

4.3.1.A Check Data Base Soft Key

The Check Database Soft Key compares the calibration database to the hard drive image and flash image. PASS/FAIL status is indicated in the Database Image, Internal Harddisk Image and Internal Flash Image fields. If Database Image FAIL(s), press the Restore Soft Key to restore calibration. If Internal Harddisk Image and/or Internal Flash Image FAIL, press Backup Database Soft Key.

4.3.1.B RPM Soft Key

Pressing the RPM Soft Key opens soft key sub-menu that contains additional soft keys.

4.3.1.C Clear RPM Soft Key

The Clear RPM Drive Soft Key deletes rpm files from the 3900's hard drive. Soft key is accessed by pressing the RPM Soft Key.

4.3.1.D Rebuild RPM Database Soft Key

The Rebuild RPM Database Soft Key rebuilds the 3900's version database for rpm package. Soft key is accessed by pressing the RPM Soft Key.

4.3.1.E Restore Soft Key

Pressing the Restore Soft Key opens soft key sub-menu that contains additional soft keys.

4.3.1.F Restore from Harddisk Soft Key

The Restore From Harddisk Soft Key restores calibration from data stored on 3900's hard drive. Soft key is accessed by pressing the Restore Soft Key.

4.3.1.G Restore from USB Soft Key

The Restore From USB Soft Key restores calibration from data on USB flash drive. Soft key is accessed by pressing the Restore Soft Key.

4.3.1.H Backup Database Soft Key

Pressing the Backup Database Soft Key backs up 3900 database to the Test Set's internal hard drive.

4.3.1.I Backup to USB Soft Key

Pressing the Backup to USB Soft Key backs up the 3900 database to a USB device. The USB device must be attached to USB connector before pressing soft key.

4.4 DISPLAY HOLD TILE

Pressing the HOLD Key freezes the current display to allow the image to be saved as a full color graphics file or to be printed to a suitable printer. The example shows a screen from the Channel Analyzer when the HOLD Key has been pressed. After the HOLD Key is pressed, the soft key menu changes to show the Print Screen and Save Screen As Soft Keys.

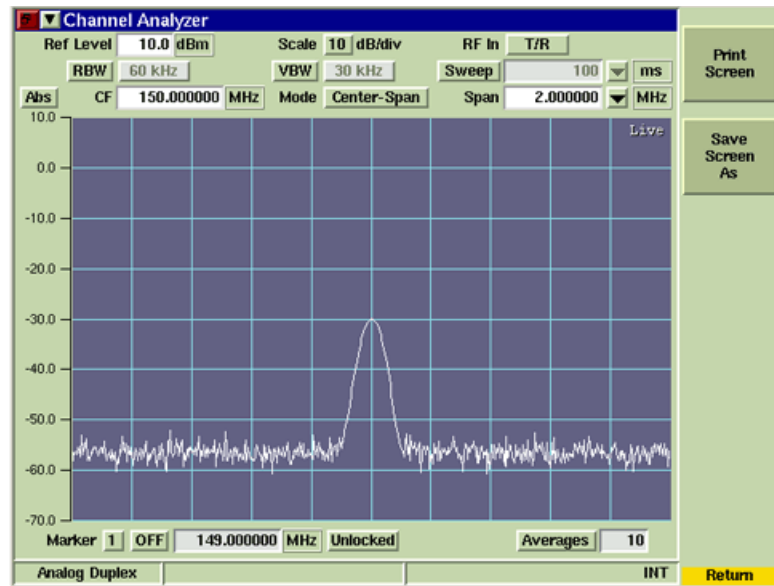

Fig. 4-3 HOLD Display Tile

4.4.1. Soft Key Definitions

4.4.1.A Print Screen Soft Key

The Print Screen Soft Key sends a captured screen display to a printer. A printer must be configured using the Test Set Printer Utility Tile to use this function.

4.4.1.B Save Screen As Soft Key

The Save Screen As Soft Key is displayed when the HOLD Soft Key has been pressed. It allows users to save the captured display to the Test Set's internal Screen Database. The File Management and Store/Recall Utility functions can then be used to retrieve and export the saved screen capture from the Test Set.

To save the screen image as a file:

STEP	PROCEDURE
------	-----------

1. Select the Save Screen As soft key.
2. Select the desired graphic format from the Filter drop-down menu. Graphic format options are JPEG files (*.jpg), bmp files (*.bmp) and png files (*.png).
3. Saved files are organized using the File Management Tile function to move them to different directories within the Test Set or to be exported to a floppy disk or USB memory stick.

4.5 ERROR LIST TILE

The Error List Tile displays a list of any recent error messages generated by the Test Set. The Test Set displays pop-up warning messages to notify users of an error condition when the Warning Soft Key is set to ON.

Refer to [Appendix G, Error Messages](#) or the Test Set's internal Help system for a description of error messages.

4.5.1. Query Errors

Query Errors generate an immediate error message that warns users when the Test Set can not process an issued remote command.

4.5.2. Command Errors

Command Error messages generate an immediate error message to warn users that they have attempted to perform an invalid operation. Command Error Messages are displayed for 3 seconds before they disappear.

4.5.3. Device Errors

Device Specific Errors generate an immediate error message to warn users when the Test Set experiences an internal fault that results in operational failure or causes the Test Set to operate outside of product specifications. Persistent Device Specific Error messages are displayed until the cause of the error is resolved.

4.5.4. Execution Errors

Execution Errors are generated immediately to warn users when the Test Set is unable to perform a requested action. Execution Error messages are displayed for 3 seconds before they disappear.

4.5.5. Warnings Soft Key Definition

The Warnings Soft Key allows the user to turn off the pop-up warning messages that are generated by the Test Set when the user attempts to enter an invalid value or parameter. When the warning messages are deactivated (OFF) the Test Set does not indicate when the user is attempting to enter an invalid value or parameter: the Test Set simply does not process the operation.



Figure 4 - 4 UTILS Error List Tile

4.6 FILE MANAGEMENT TILE

The File Management Tile allows users to transfer files to and from the Test Set. The functionality can be used to transfer files to an external device such as a computer in order to create a backup set of calibration files, stored setup files or stored autotest results. The File Management Tile can also be used to transfer test scripts to the Test Set from an external device. External files must be imported to the proper directory Test Set before they can be accessed on the unit.

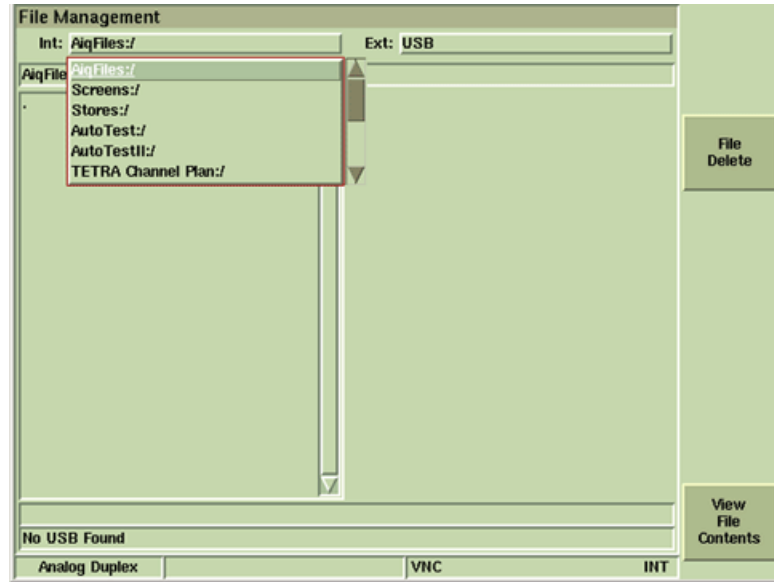

Fig. 4-5 File Management Tile

4.6.1. File Management Types

File Management categorizes saved files into the following groups:

4.6.1.A AutoTest and AutoTest II

Selecting AutoTest or AutoTest II accesses any Script files that are available for use on the Test Set and to any test results that have been stored in the unit. The AutoTest and AutoTest II drive locations are only available when the options have been installed in the Test Set.

4.6.1.B Screens

Selecting Screens accesses any files that may have been saved by using the screen capture function associated with the Display Hold Key.

4.6.1.C Stores

Stores accesses any Settings files that may have been saved by using the Store/Recall File.

4.6.1.D TETRA Channel Plan

Selecting TETRA Channel Plan accesses Channel Plan files that are common to all TETRA Systems.

4.6.1.E TETRA MS/MST1/BS/BST1/DM Data Display

Selecting TETRA Data Display provides access to saved Data Display files that have been saved within the selected TETRA System.

4.6.1.F AiqFiles

Selecting AiqFiles accesses IQCreator waveform files that have been down-loaded and stored in the Test Set. This drive location is only available when the IQ Gen Modulation Option (390XOPT054) has been installed in Test Set.

4.6.2. File Management Tile Layout and Navigation

The File Management Tile is divided into two sections: the left side displays Internal Drive data; the right side displays External Drive data. Navigate using the Cursor Keys or Rotary Control Knob. Press the SELECT Key to focus on a field or section of the tile.

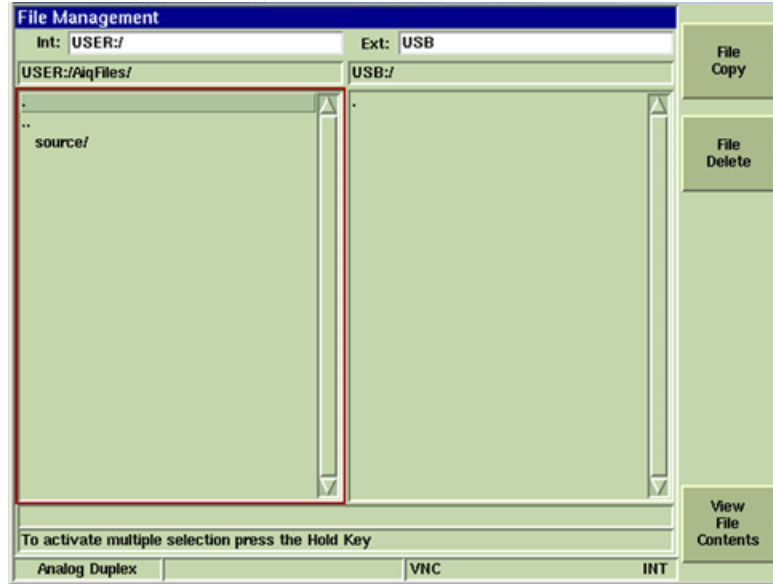

Fig. 4-6 File Management Tile Layout

4.6.3. File Selection

To select a file, open the Directory and highlight the desired file. Multiple files can be selected by pressing the HOLD Key and selecting the desired files.

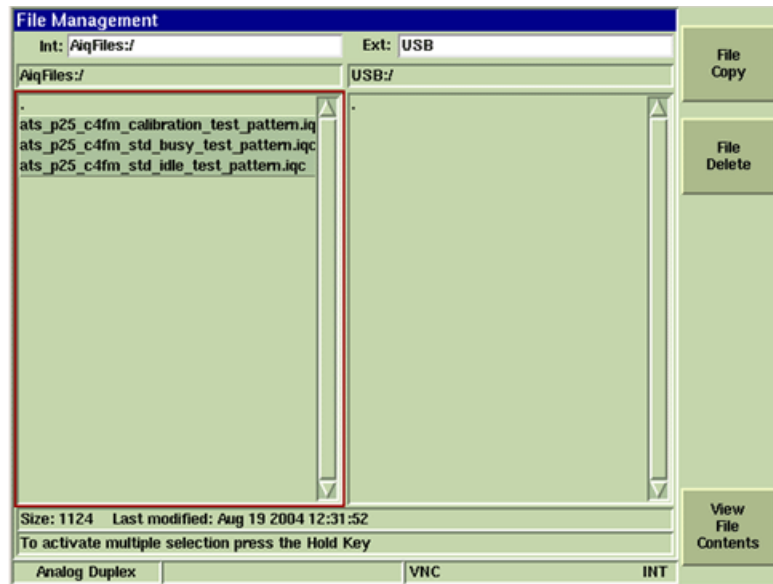

Fig. 4-7 File Management - Multiple Files Selected

4.6.4. Samples

The Samples directory contains saved setup files that have been configured for performing common test operations. The sample test setups can be customized and saved as different files or they can be used in their default configurations. Sample files are reconfigured to factory default parameters when the Restore Factory Defaults procedure is performed.

4.6.5. Field/Soft Key Definitions

4.6.5.A Internal/External Data Field

The Int: drop down menu selects the internal source of the file. Menu content depends on the options installed in the Test Set.

The Ext: drop down menu selects the external source where files are to be copied from or to.

4.6.5.B File Copy Soft Key

Copies selected file(s) from USB device to Test Set and vice versa.

4.6.5.C File Delete Soft Key

Pressing this key deletes selected file(s). A prompt dialog box as shown below requests that the user confirms file deletion.

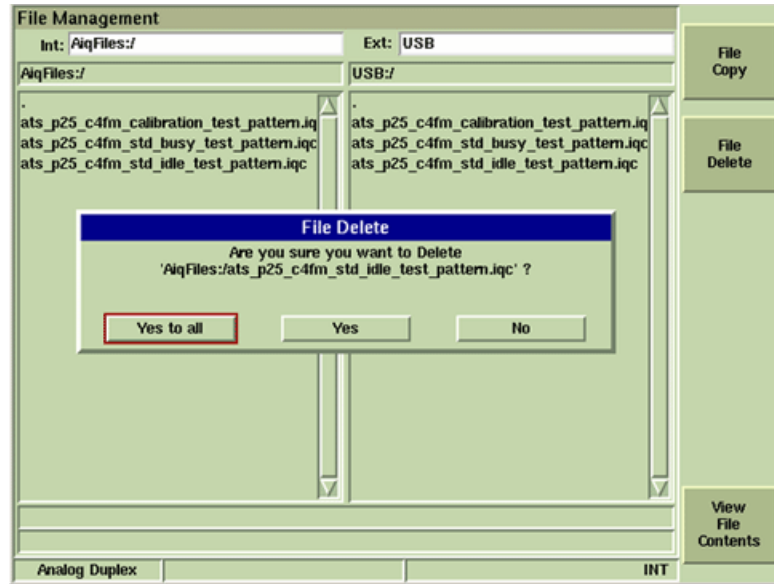

Fig. 4-8 File Management - File Delete Confirmation Prompt

4.6.5.D Make Directory Soft Key

Creates a directory on USB device. This soft key is only visible when a USB device is attached to Test Set.

4.6.5.E View File Contents Soft Key

Displays contents of selected file. Only one file can be selected for viewing. Valid file types are Autotest and AutoTest II script files and test results, Stored Screen captures and IQCreator waveform files.

4.6.6. Transferring Files

NOTE	Verify files are placed in the proper directory structure when transferring files to and from the Test Set. Failure to place files in the proper directory may result in system errors.
-------------	---

4.6.6.A Copying Files to Test Set

To import a file to the Test Set while operating in Test Mode:

STEP	PROCEDURE
1.	Press UTILS Key twice to access the UTILS Floating Menu.
2.	Select File Management from the UTILS Floating Menu
3.	Connect memory device (example uses USB device) to Test Set USB Connector.
4.	Select internal drive to copy file(s) to (example uses AiqFiles).
5.	Select external drive to copy file(s) from (example uses USB).
6.	The File Management Tile opens for the selected file type. The data field on the left is empty if no files have been imported to this drive directory. The field to the right displays the file to be copied from the USB to the Test set.

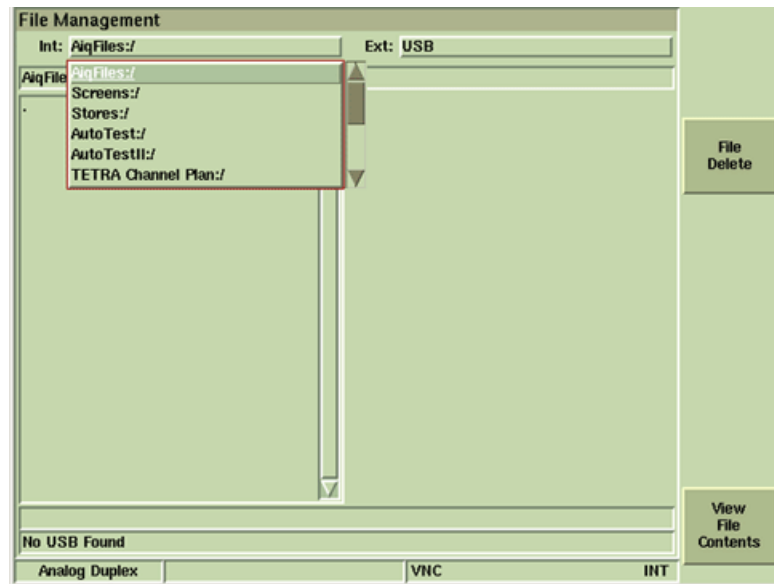

Fig. 4-9 File Management - Selecting File

STEP

PROCEDURE

- 7. Select file(s) to be copied from USB and press File Copy Soft Key.

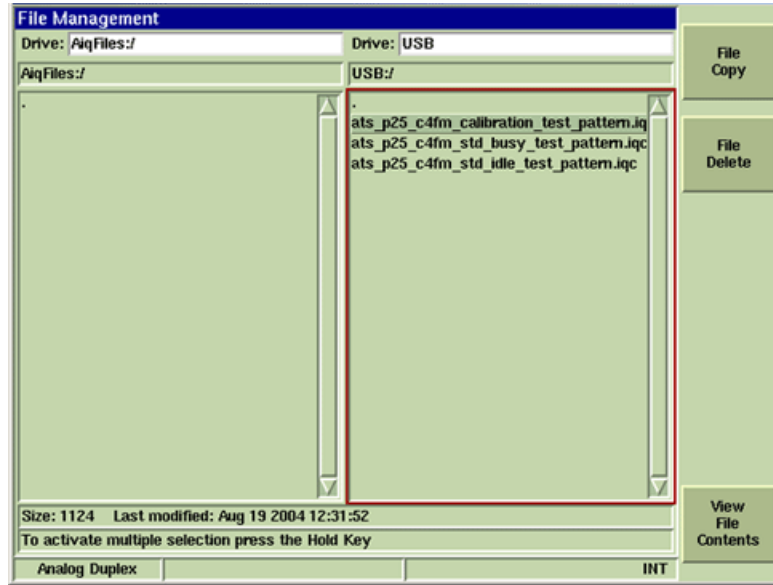

Fig. 4-10 File Management Tile - File Selected to Copy

- 8. Imported file(s) now appears in data field.

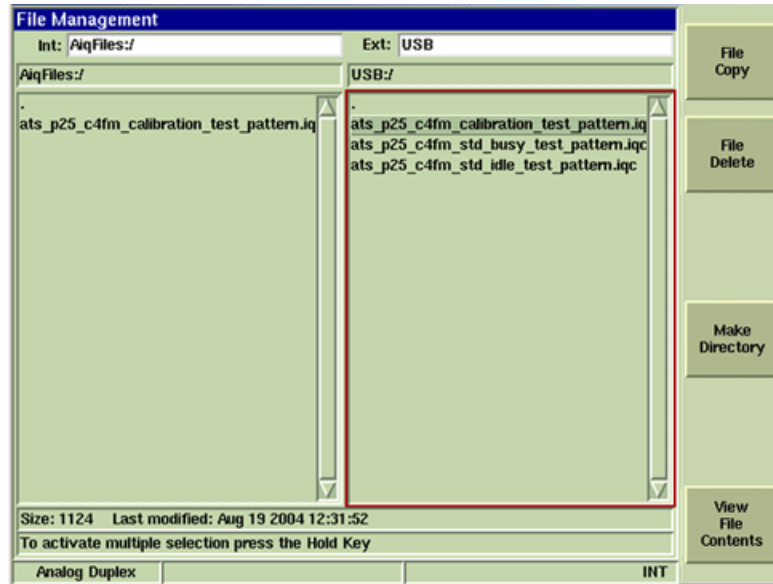

Fig. 4-11 File Management Tile - Copy Complete

4.6.6.B Copying Files from Test Set

To copy files from Test Set while operating in Test Mode:

STEP PROCEDURE

1. Press UTILS Key to access the UTILS Menu.
2. Select File Management from the UTILS Menu.
3. Connect memory device (example uses USB device) to Test Set USB Connector.
4. Select internal drive to copy file(s) from (example uses AiqFiles).

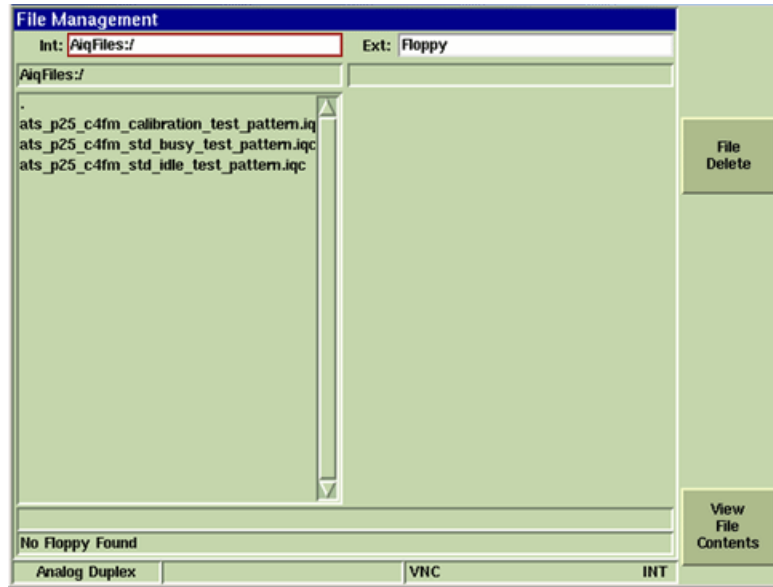

Fig. 4-12 Select Internal Drive

5. Select External drive to copy file(s) from (example uses USB).

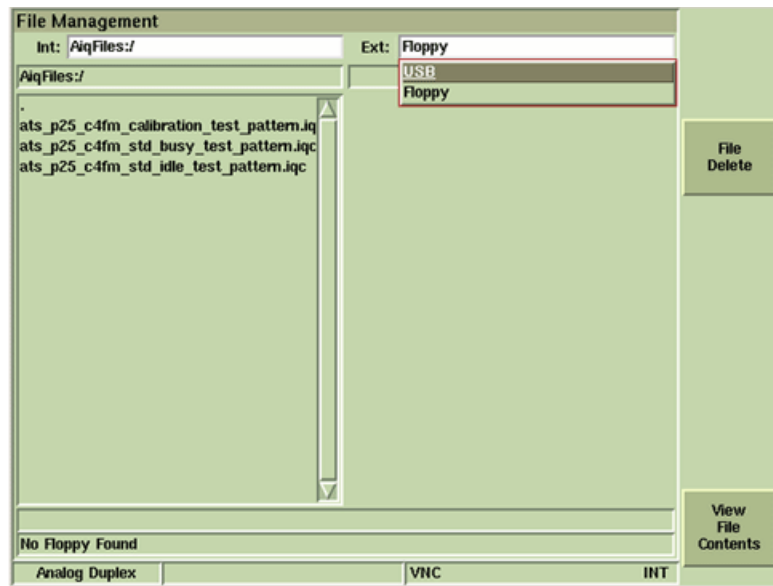

Fig. 4-13 Select External Drive

STEP

PROCEDURE

6. Select file to be copied from Test Set to USB device and press the File Copy Soft Key. File appears under the USB:/ Directory when copy is complete.

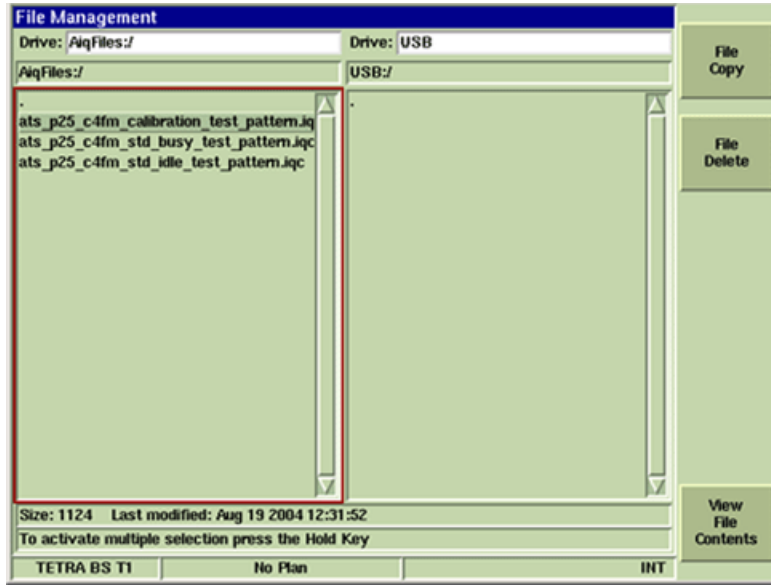

Fig. 4-14 File Management - File Selected

4.7 FREQUENCY REFERENCE TILE

The Frequency Reference Tile locks the Test Set to the internal frequency standard or to an external signal from the Ext Ref I/O connection.

The Reference (Internal/External) drop-down menu defines the reference source as internal or external. When external is selected an external source must be connected to the Ext Ref I/O Connector on the Rear Panel. Incorrect Reference setting results in error message shown below.

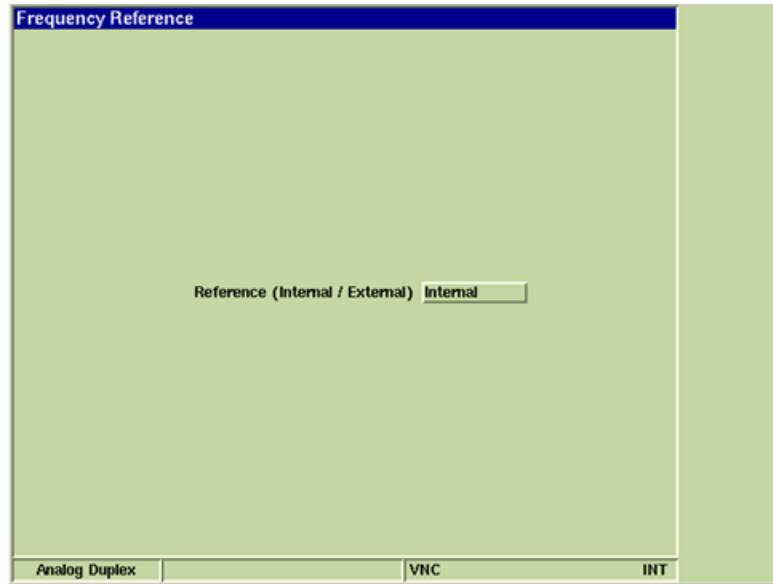

Fig. 4-15 UTILS Frequency Reference Tile

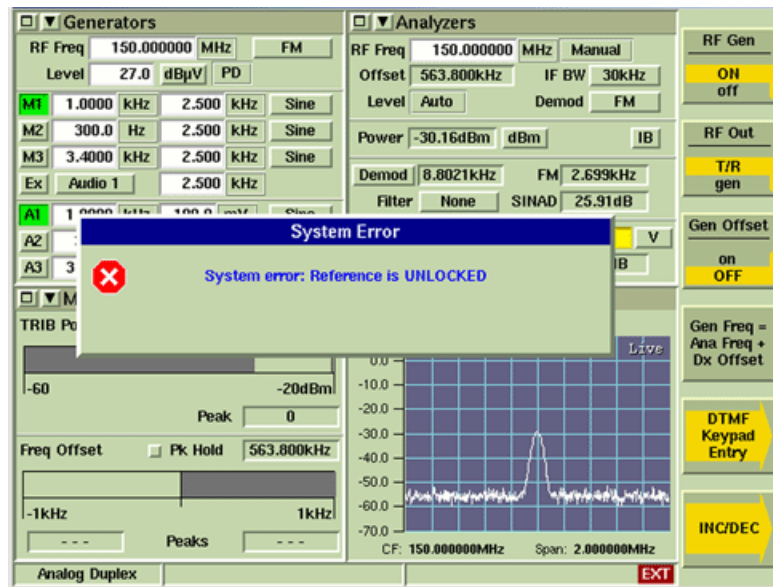

Fig. 4-16 Reference Unlocked Error Message

4.8 HELP SYSTEM

The 3900 contains an html based internal Help System that provides quick access to Test Set information, specifications and demonstration video clips. The Main Help Tile contains links associated with Test Set systems, operation, data and specifications. There is also an alphabetical index which lists information by subject.

The Help System is designed to open information pertaining directly to the function being performed when the HELP Key is pressed. For example, if the Analog Duplex Generators Tile is selected, and the HELP Key is pressed, the Help System opens at the section describing the Generators Tile.

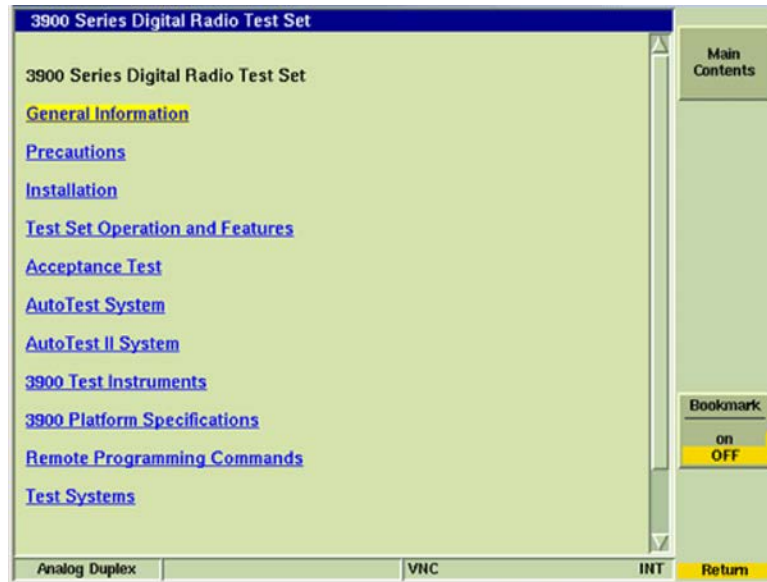

Fig. 4-17 Main Help Tile



Fig. 4-18 Example of Help File Contents

4.8.1. Soft Key Definitions

4.8.1.A Main Contents Soft Key

Opens the main tile in the Help System.

4.8.1.B Back Soft Key

Goes to previous Help Tile.

4.8.1.C Bookmark Soft Key

This soft key sets a marker within the Help System that allows the user to return to a specific location within Help the next time the HELP Key is pressed. When a Help 'page' is bookmarked, a <Bookmark> indicator appears in the Tile title bar. The user can then return to TEST mode, CONFIG mode or UTILS mode and continue with testing. The next time the HELP Key is pressed, the Spectrum Analyzer Help Tile opens.

NOTE

HELP continues to open to the Bookmarked Tile until the Bookmark is turned OFF. Bookmarks are maintained when Operating System is changed.

4.8.1.D Return Soft Key

Exits Help System, returning to last used operating system (i.e., TEST Mode or CONFIG Mode). Can also press the TEST Key, CONFIG Key or UTILS Key to exit Help System.

4.9 KEYBOARD & MOUSE TILE

The Keyboard & Mouse Tile allows users to customize performance of a USB keyboard and/or mouse that is connected to the Test Set.

Settings made to this tile do not affect functionality of the Test Set's Front Panel keypad. Refer to section titled USB Connector and Keyboard Interface Connector in Chapter 3 for information on using a Mouse with the Test Set.



Fig. 4-19 UTILS Keyboard & Mouse Tile

4.9.1. Field Definitions

4.9.1.A Cursor Hide Delay

The Cursor Hide Delay field sets how long (in seconds) mouse can remain inactive before cursor disappears. Moving the mouse reactivates cursor.

4.9.1.B Sensitivity

The Sensitivity field sets how fast the cursor moves across display tile when a mouse is connected to the Test Set.

4.9.1.C Keyboard Selection

The Keyboard Select drop-down menu selects the manner in which an external keyboard operates when connected to the Test Set.

Internal setting uses multi-press alpha/numeric functionality on the Test Set and USB keyboard numeric keypad.

External setting de-activates the multi-press alpha/numeric functionality of the Test Set and the USB numeric keyboard.

4.10 LANGUAGE SELECT

The Language Select Utility Tile is enabled when a language option is installed in the Test Set. The tile allows the user to select the language used to label Analog Duplex display tiles.

The Test Set currently offers Chinese as a language option (390XOPT090) as shown in Fig. 4-21. English is the default language when an optional language option is installed in the Test Set. Product documentation is only supported in English.

NOTE Saved file setups must be saved and recalled in the same language. For example, a setup file save in English can not be recalled in Chinese.



Fig. 4-20 Language Select Tile

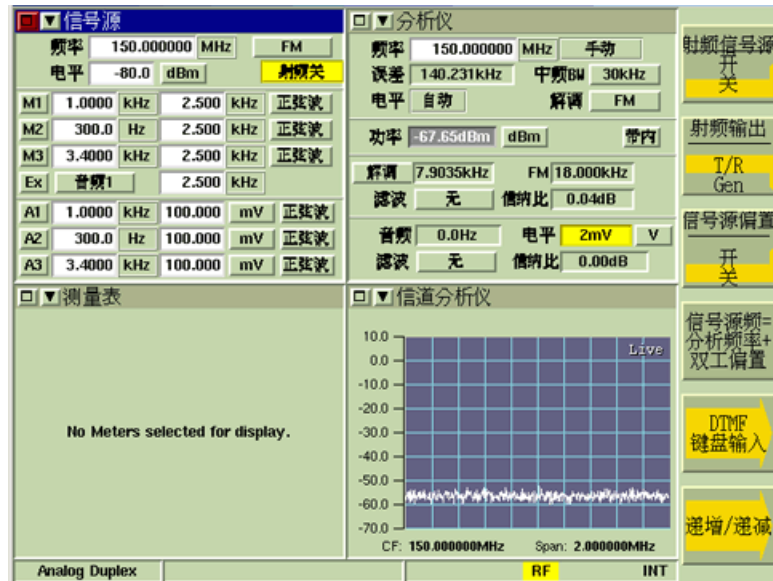

Fig. 4-21 Chinese Language Support

4.11 LICENSE TILE

The License Tile displays the unit’s serial number, lists the options currently installed in the Test Set and allows users to install new options in the Test Set.

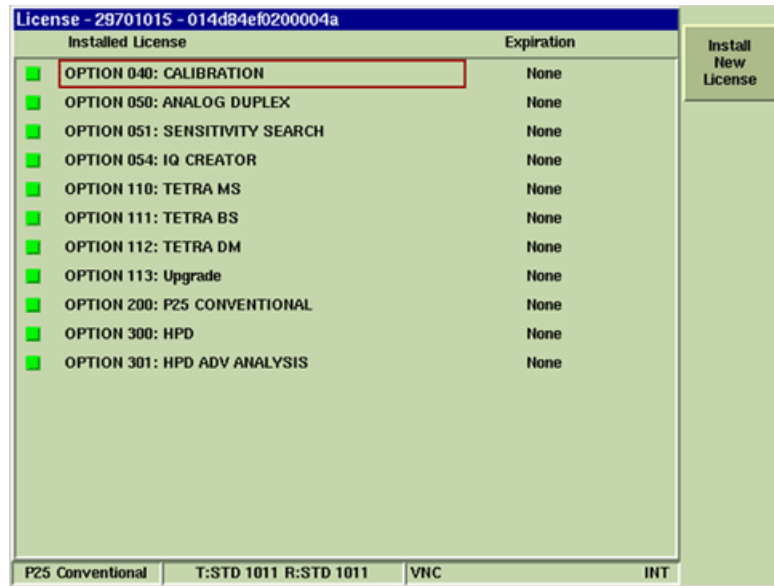

Fig. 4-22 UTILS Software License Tile

4.11.1. Test Set Options General Information

Test Set options consist of two components: an option software file(s) and an option license file. The option software file(s) contains software specific to option functionality. The option license file is used to activate the option software files.

4.11.2. Option Distribution

VIAVI distributes option license files in a .zip file. The .zip file contains an option license file (options.new) and in some cases a software file (file with .rpm extension).

NOTE	The contents of the .zip file are binary files which will not be recognized on a computer. Do not attempt to open any of the files.
-------------	---

4.11.3. New Option vs Option Update

4.11.3.A New Option

A “new Option” is an option which is not yet installed in the Test Set. Installing a new option in the Test Set requires installing an option license file (options.new) and in some cases installing software files (.rpm file[s]).

If the contents of the .zip file include any files with a .rpm extension, the option installation requires two steps. The first step is to install the option license file (options.new) in the Test Set. The second step is to install the option software .rpm file(s) in the Test Set.

4.11.3.B Option Update

An “option update” is a software update to an option already installed in the Test Set. Option updates are completed by loading option software .rpm file(s) in the Test Set. If the .zip file only contains a file(s) with a .rpm extension, proceed to the How to Upgrade Software to update the option.

4.11.4. How to Install a New Software Option

4.11.4.A Preliminary Steps

Perform the following before proceeding:

- Verify the file(s) is being installed in the Test Set for which it was issued. An option license file is serial number specific and can only be installed in the Test Set for which it was issued. An attempt to install a license file in a Test Set other than the one for which the license was issued generates an error message and causes the installation to fail.
- Copy the .zip file to a USB memory device and extract the .zip file contents to the top level of a USB memory device. Verify the extracted file(s) is placed in the directory structure DRIVE:\Instrument\3900 directory (refer to Fig. 4-23).

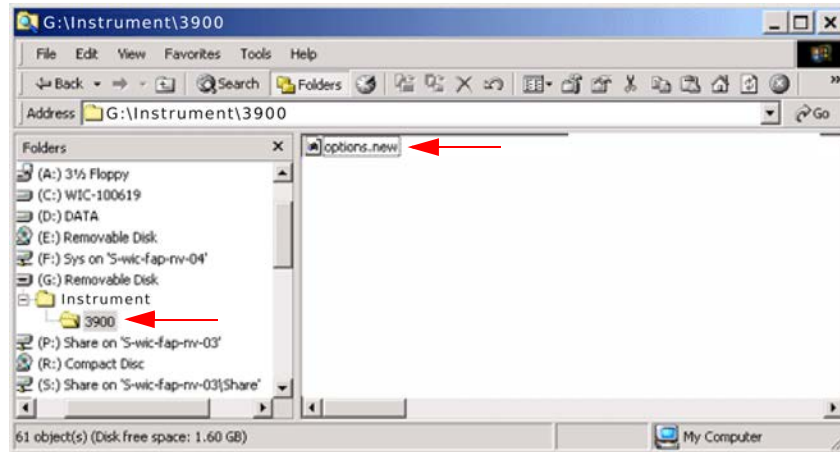

Fig. 4-23 Directory Format for License Installation

- Determine if the option includes software files. If the .zip file contains any file(s) with a .rpm extension, the Software Upgrade Procedure must be performed to complete the option installation process (refer to How to Upgrade Software).

4.11.4.B Install New Option License File (options.new file)

STEP	PROCEDURE
1.	Power on the Test Set.
2.	Connect the USB memory device containing the option file(s) to one of the Test Set's USB Connectors.
3.	Press the UTILS Key to access the Utilities floating menu.
4.	Select Store/Recall.
5.	Press Restore Factory Defaults Soft Key. At prompt select All Systems.
6.	From the Default Tile, press the UTILS Key twice to access the Utilities floating menu.
7.	Select Software Settings, License from the Utilities floating menu.
8.	Press the Install New License Soft Key on the License Tile.
9.	Press the USB Memory Update Soft Key.
10.	Wait while the Test Set performs a sequence of automated processes. Status messages are displayed throughout the automated processes. Do not interrupt this process or the installation will fail.
11.	At prompt, confirm shutdown and reboot the Test Set.
12.	If the .zip file contained any files with a .rpm extension, proceed to section titled How to Upgrade Software to complete option installation.

4.12 OPERATIONAL STATUS TILE

The Operational Status Tile displays the Test Set’s operational parameters. The Fan Control and AC Power Control are the only parameters that can be manually configured. All other data is system generated. Refer to 3900 Platform Specifications for maximum input levels.

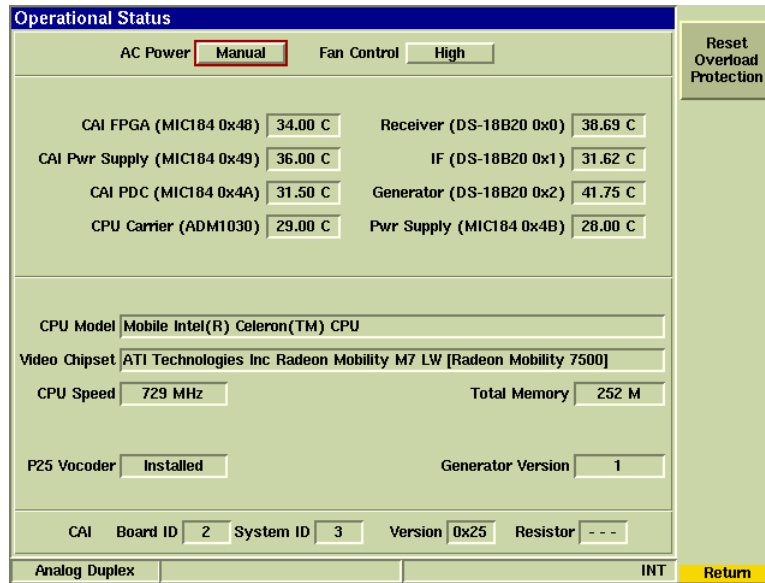

Fig. 4-24 Operational Status Tile

4.12.1. Field/Soft Key Definitions

4.12.1.A Fan Control

This setting controls the fan speed of the 3900’s internal cooling fans. Fan speed should be set to correspond to the external environment in which the Test Set is being used. For example, a High fan setting is recommended if the equipment is used in a rack system environment where it is surrounded by other heat-generating equipment.

The RPM field varies according to how fast the fan needs to spin in order to maintain the Test Set’s current internal temperature.

NOTE If fan speed is set too low for the current operating conditions, the Test Set auto adjusts the fan speed to higher setting.

4.12.1.B Reset Overload Protection

Resets the Test Set’s input overload relay. When input exceeds maximum levels, the Test Set generates an audible alarm tone. The alarm tone stops when the overload input is disconnected from the Test Set, however, this soft key must be pressed to reset the Test Set’s overload warning system.

Refer to 3900 Platform Specifications for maximum input levels.

4.12.1.C AC Power

The AC Power setting defines the manner in which the unit reboots following a power outage. When set to Auto, the Test Set automatically reboots when power is restored following a power outage. When set to Manual, the unit must be manually powered on when power is restored following a power outage. This feature is currently only supported in the 3920.

4.13 PRINTER CONFIGURATION TILE

The 3900 Test Set supports a large selection of laser, ink jet and dot matrix printers. Use the Printer Configuration Tile drop-down menus to select the make and model of printer.



Fig. 4-25 UTILS Printer Configuration Tile - Main Tile

4.13.1. Field/Soft Key Definitions

4.13.1.A Manufacturer

Selects printer make to be configured for use. Drop-down menu lists manufacturers supported by Test Set. This field is enabled by pressing the Select New Printer Soft Key.

4.13.1.B Model

The Model drop-down menu selects printer models the Test Set supports for selected Manufacturer. This field is enabled by pressing the Select New Printer Soft Key.

4.13.1.C Connection

The Connection drop-down menu selects the type of printer port to be used. The printer can be connected to either the Parallel Printer Connector, to one of the USB ports or to a Common Unix Printing System (CUPS) server. This field is enabled by pressing the Select New Printer Soft Key.

4.13.1.D Select New Printer Soft Key

The Select New Printer Soft Key allows the user to configure the Test Set for use with a specific printer.

4.13.1.E Install Soft Key

Pressing the Install Soft Key configures Test Set to print to a selected printer based on data selected from drop-down menus. This field is enabled by pressing the Select New Printer Soft Key. Refer to printer installation procedures for information about how to configure printers.

4.13.1.F Remove Current Printer Soft Key

The Remove Current Printer Soft Key is accessed by pressing the Install New Printer Soft Key. Pressing the Remove Current Printer Soft Key clears the printer information stored for the printer that is currently installed. This soft key is only visible when the Test Set has a printer installed.

4.13.1.G Reset Print Server Soft Key

Pressing this key resets the Common Unix Printing System (CUPS) for network printing capabilities.

4.13.1.H Print Test Page Soft Key

Sends test page to printer to verify printer configuration is correct. This soft key is only displayed when a printer is installed.

4.13.1.I Delete Print Job Soft Key

Cancels current print job. This soft key is only displayed when a printer is installed.

4.13.2. How to Install USB or Parallel Printer Connection

- | STEP | PROCEDURE |
|------|---|
| 1. | Connect printer to be installed to Test Set USB or Parallel Printer Connector. |
| 2. | Open Printer Configuration Utility Tile. Press the Select New Printer Soft Key. |
| 3. | Open Connection drop-down menu and select USB Port or Parallel Port. |
| 4. | Open Manufacturer drop-down menu and select the manufacturer name of the printer to be installed. |
| 5. | Open Model drop-down menu and select model name of printer to be installed. |
| 6. | Press the Install Soft Key. Wait while Test Set updates settings and restarts Printer Server. |
| 7. | When printer installation is complete, the Printer Configuration Tile updates to display printer information (Fig. 4-26). |

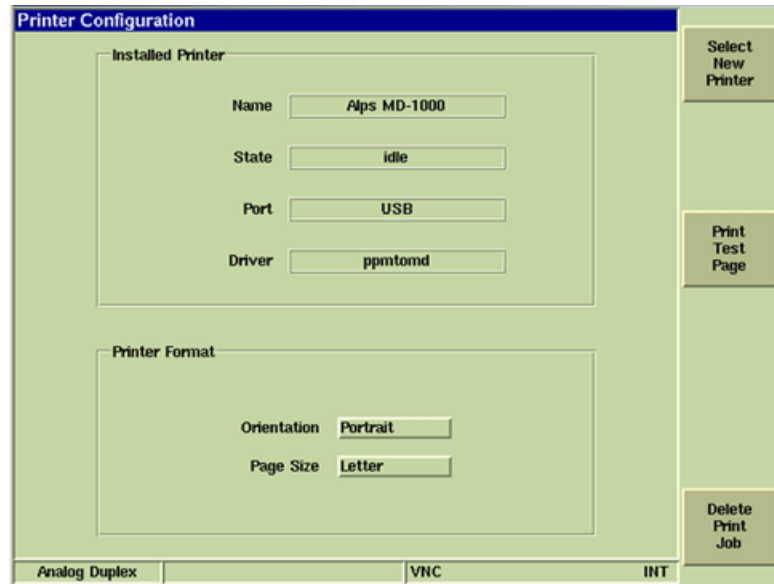

Fig. 4-26 USB Printer Installation Complete

4.13.3. How to Install Network Printer

STEP	PROCEDURE
------	-----------

1. Open Network Utility Tile. Configure Test Set for Network Operation.
2. Define Print Server fields with a CUPS IP Address.
3. Open Printer Configuration Utility Tile. Press the Select New Printer Soft Key.
4. Open Connection drop-down menu and select Networking. Wait while Test Set retrieves list of available printers.

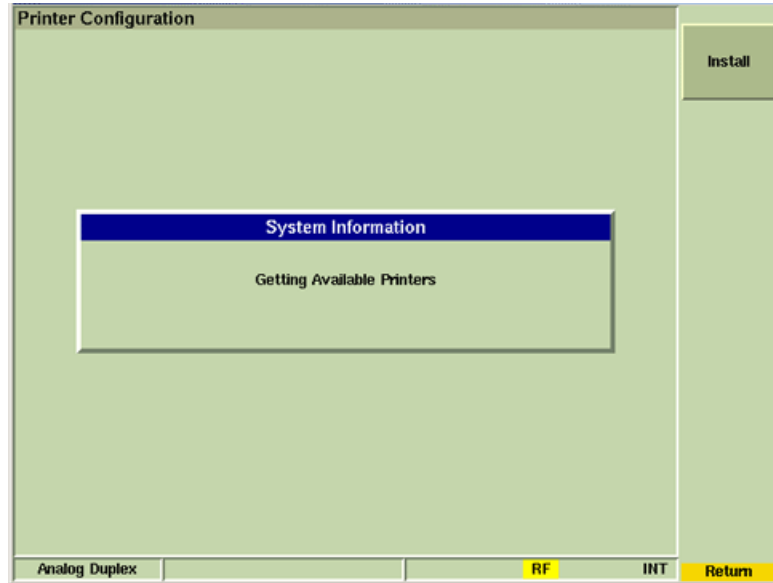

Fig. 4-27 Network Printer Setup - Available Printers

5. Select printer to be installed from Printer drop-down menu. Wait while Test Set validates printer connection. When complete, press Install Soft Key to complete printer installation.
6. When printer installation is complete, the Printer Configuration Tile updates to display printer information (Fig. 4-28).

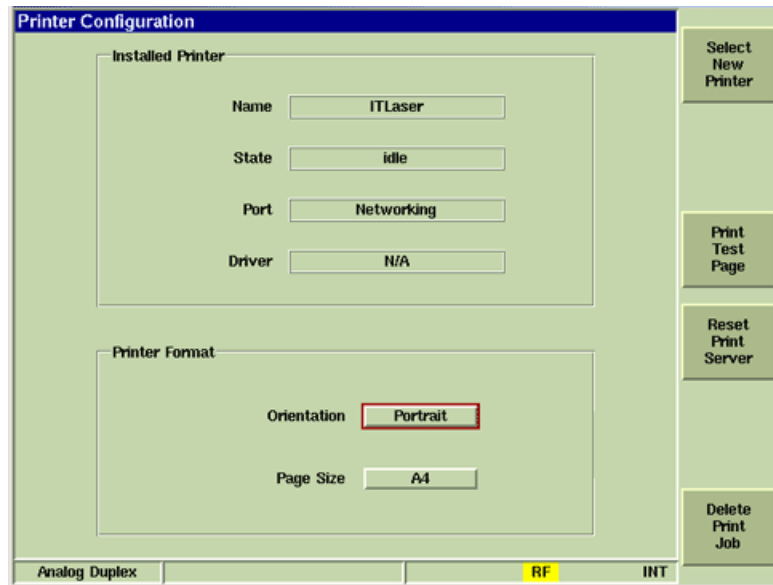

Fig. 4-28 Network Printer Installation Complete

4.14 REMOTE TILE

The Remote Tile allows users to configure the Test Set to allow access from an external controller.

Depending on the Remote Source selected, parameters may also need to be configured on the Network Tile.

The screenshot shows a configuration window titled "Remote" with a light green background. It contains several input fields:

- Remote source:** A dropdown menu with "TCP/IP" selected and highlighted by a red box.
- GPIB Address:** A text box containing the number "3".
- TCP/IP Port:** A text box containing the number "1234".
- VNC Viewer Password:** A text box containing "3900".
- VNC Viewer Message:** An empty text box.

 At the bottom, there is a navigation bar with buttons for "NXDN", "Basic 800", "INT", and a yellow "Return" button.

Fig. 4-29 UTILS Remote Tile

4.14.1. Field Definitions

4.14.1.A Remote Source

4.14.1.A.1 Off

Disables remote access.

4.14.1.A.2 GPIB

Enables GPIB remote operation. Selecting GPIB requires an address to be set in the GPIB Address field.

4.14.1.A.3 TCP/IP

TCP/IP enables remote operation over an ethernet connection. When TCP/IP is selected, a value must be defined in the TCP/IP Port field. Use of TCP/IP also requires network access which is configured on the Utilities Network Tile.

4.14.1.B GPIB Address

The GPIB Address field sets the Test Set's primary GPIB address for use with GPIB remote operation.

4.14.1.C TCP/IP Port

The TCP/IP Port field sets the Test Set port for use with Telnet remote operation.

4.14.1.D VNC Viewer Password

The VNC Viewer Password field sets the password required for VNC client to access the Test Set via the ethernet.

4.14.1.E VNC Viewer Message

Defines the text displayed on the title bar of the VNC Viewer Window.

4.14.2. Access Test Set via GPIB Connection (RCI Operation)

To access Test Set via GPIB Connection:

STEP PROCEDURE

1. Set Remote Source field on Remote Tile to GPIB.
2. Set GPIB Address on Test Set.

When the Test Set is being control remotely using a GPIB connection, the Go To Local Soft Key is enabled. Pressing this soft key allows a user to access the Test Set using local (front panel) controls.

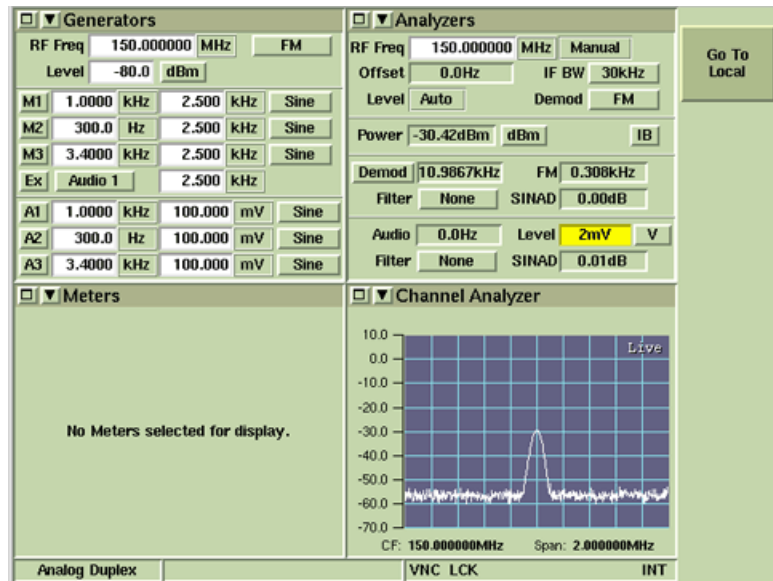

Fig. 4-30 GPIB Go To Local Soft Key

4.14.3. Access Test Set via Internet Browser (GUI Operation)

To access Test Set via Internet browser:

STEP PROCEDURE

1. Configure Test Set for network access (refer to Network Tile).
2. Define VNC Viewer Password field on Remote Tile.
3. Open Internet browser and enter Test Set's IP address, followed by :5800 (e.g. http://12.345.678.910:5800).
4. Enter password (as defined in VNC Viewer Password field) at prompt.

4.14.4. Access Test Set via VNC Connection (GUI Operation)

To access Test Set via VNC Connection:

STEP	PROCEDURE
------	-----------

1. Configure Test Set for network access (refer to Network Tile).
2. Define VNC Viewer Password field on Remote Tile.
3. Open VNC Client and enter Test Set IP Address (as configured on Network Tile).
4. Enter password (as defined in VNC Viewer Password field) at prompt.

For more information, including downloading a VNC client see <http://www.realvnc.com/> or <http://www.tightvnc.com/>.

4.14.5. Access Test Set via Ethernet Connection (RCI Operation)

To access Test Set via Ethernet Connection:

STEP	PROCEDURE
------	-----------

1. Configure Test Set for network access (refer to Network Tile).
2. Set Remote Source field on Remote Tile to TCP/IP.
3. Set TCP/IP Port field on Remote Tile to match your Network Configuration (see your IT Department for this information).
4. The Test Set can now be accessed using desired application. For example, open a command window and enter telnet Test Set's IP Address TCP/IP Port. Refer to example below which shows an open command window connected to Test Set IP Address 10.200.144.74 on port 1234.

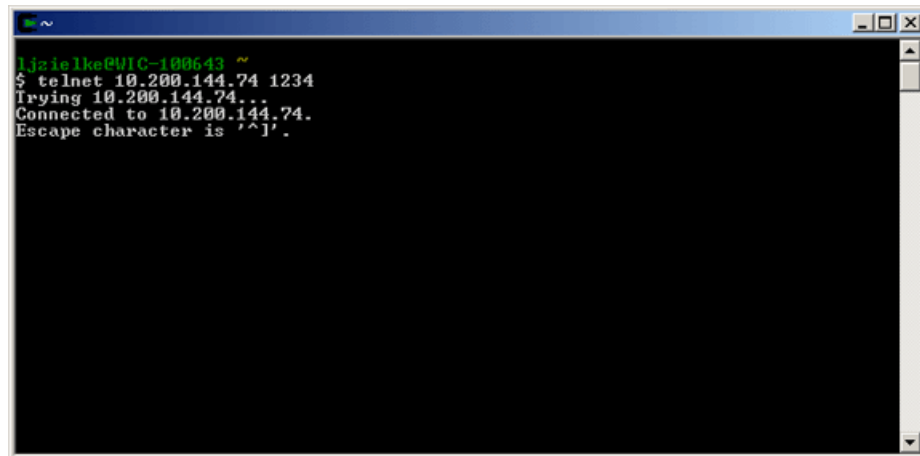

Fig. 4-31 Command Window Example

4.14.6. Access Test Set via WinSCP

WinSCP must be downloaded to user’s computer work station prior to setup. WinSCP can be downloaded at winscp.net.

The WinSCP Window lists the directories found on the Utils File Management Tile. WinSCP allows the user to transfer 3900 compatible files directly to the available Test Set directories.

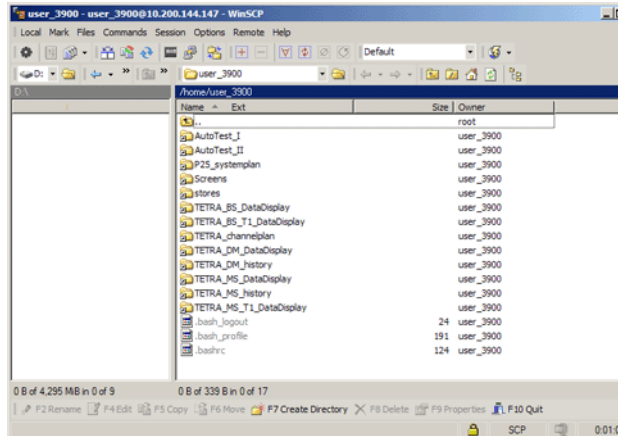

Fig. 4-32 WinSCP Login Window (Version 4.1.8.415)

To access Test Set via WinSCP:

STEP

PROCEDURE

1. Configure Test Set for network access (refer to Network Utility Tile).
2. Open WinSCP.exe. Set Host Name field on WinSCP Login window to match the Test Set IP Address configured on the Network Utility Tile.
3. Verify Port Number field on the WinSCP Login window is set to 22.
4. Enter user_3900 in User Name field. Enter 3900 in Password field.
5. Verify that SCP Protocol is selected.
6. Press Login button to open WinSCP window.

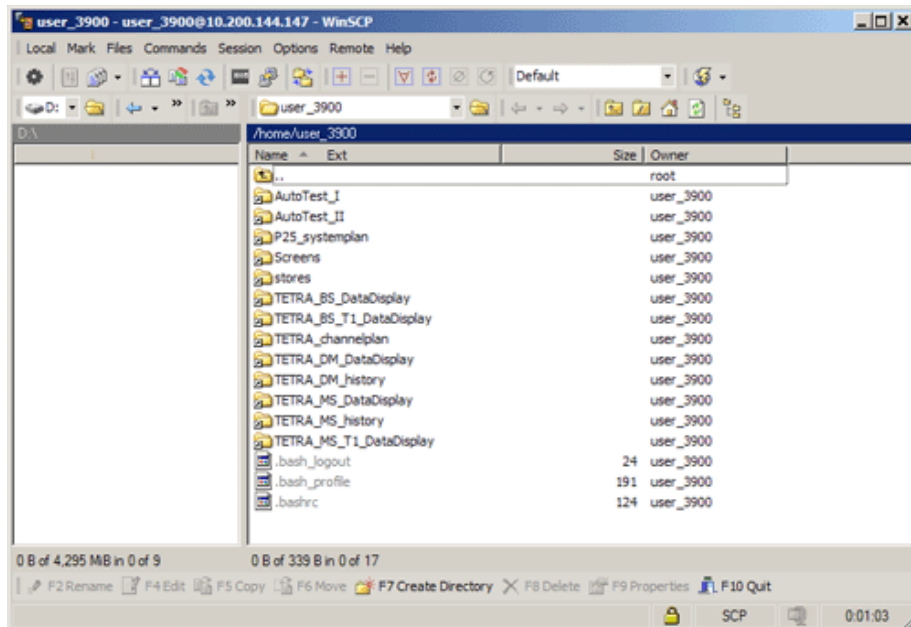

Fig. 4-33 WinSCP Window (Version 4.1.8.415)

STEP

PROCEDURE

7. After Login is complete, select Options, Preferences from the WinSCP toolbar. Open the Transfer tab and verify that "Preserve Timestamp" is not selected.

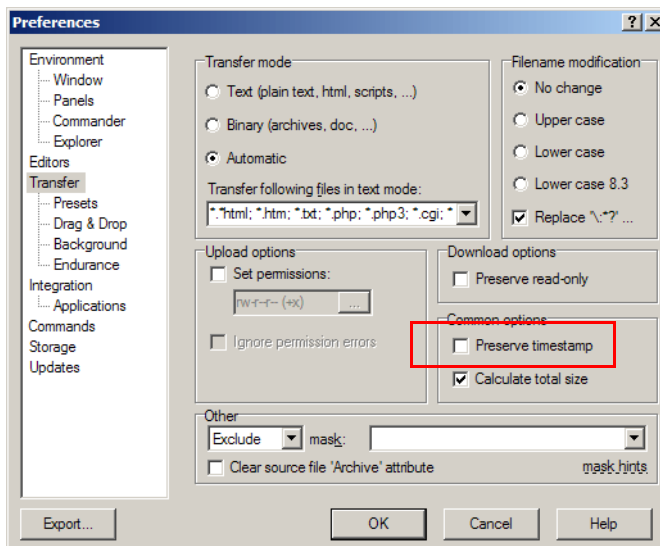

Fig. 4-34 WinSCP Transfer Preferences - Disable Timestamp

4.15 SOFTWARE UPGRADE TILE

The Software Upgrade Tile displays a list of software that is installed in the Test Set. The list includes the system base software and any options that are installed in the unit. The list also identifies software version information.

The Software Upgrade Tile is used to update software already installed in the Test Set and install new software options. Refer to section 4.11, [License Tile](#) for information about installing software options.

The Software Upgrade Tile is accessed from the Utils/Software Settings drop-down menu.

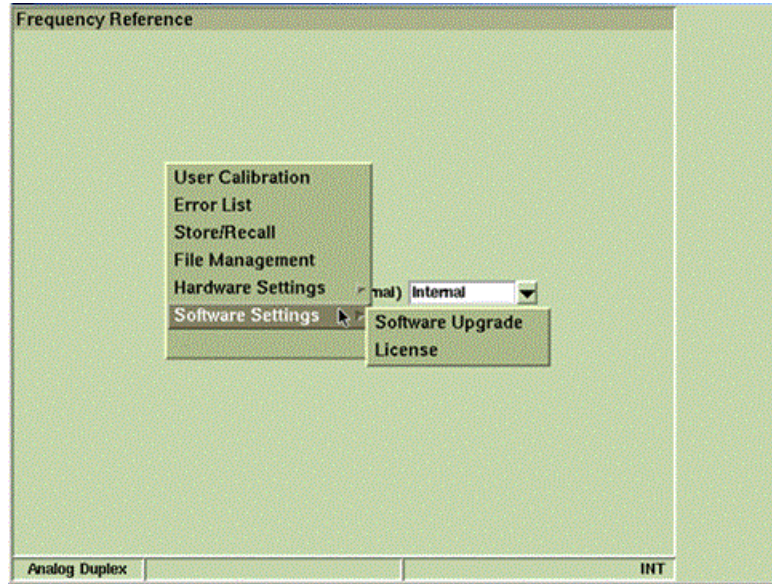

Fig. 4-35 Accessing Software Upgrade Function

4.15.1. Test Set Software General Information

4.15.1.A Current Software Version

Open the Software Upgrade Tile to view the list of software that is installed in the unit. The list indicates the software version and includes any options that are installed in the unit as well as any available options which are not installed in the Test Set.

Software Upgrade			Check for Upgrades
Package Name	Version	Upgrade Version	
<input type="checkbox"/> BASE_CONFIG_02	3.2.0		
<input type="checkbox"/> OPTION_240	3.2.0		
<input type="checkbox"/> OPTION_601	3.1.0		
<input type="checkbox"/> OPTION_602	3.9.0		
<input type="checkbox"/> OPTION_603	1.8.6		
<input type="checkbox"/> OPTION_604	2.8.1		
<input type="checkbox"/> OPTION_605	Not Installed		
<input type="checkbox"/> OPTION_606	1.8.4		
<input type="checkbox"/> OPTION_607	1.8.3		
<input type="checkbox"/> OPTION_608	1.8.6		
<input type="checkbox"/> OPTION_610	2.0.1		
<input type="checkbox"/> OPTION_611	1.8.9		
<input type="checkbox"/> OPTION_614	2.0.2		
<input type="checkbox"/> OPTION_615	2.0.3		
<input type="checkbox"/> OPTION_616	1.1.7		
<input type="checkbox"/> OPTION_620	0.9.9		
<input type="checkbox"/> OPTION_621	0.9.9		
Default		INT	Return

Fig. 4-36 System Software Information

4.15.1.B Software Option

Software options are optional Test Set functions which are either factory installed when the Test Set is purchased or installed and/or activated in the field (post-production). Post-production software options are distributed via email or on a CD/DVD in a compressed file (.zip).

NOTE The contents of the .zip file are binary files which will not be recognized on a computer. Do not attempt to open any of the files.

4.15.1.C System Software

System software is the Test Set's basic operating system. System software is factory installed and can be updated in the field. The current version of 3900 system software is available for download

4.15.2. Soft Key Definitions

4.15.2.A Check for Upgrades Soft Key

This soft key accesses a soft key sub-menu from which the user selects the source of the software download (Network or USB Memory). When the Network or USB Memory Soft Key is pressed, the Test Set queries the selected software upgrade source to determine if there are any available upgrades for the software currently licensed on the unit.

4.15.2.A.1 USB Memory Upgrade Soft Key

This soft key selects a USB device as the software upgrade source. Software files must be properly configured on the USB device before beginning the Software Upgrade Procedure. Refer to [4.15.3.B, REQUIRED Preliminary Procedures](#).

4.15.2.A.2 Network Upgrade Soft Key

The Network Upgrade Soft Key downloads software to the Test Set from a user's network http server. The http server IP address is defined on the Utils Network Tile (Software Update fields). 3900 Software must be downloaded from the VIAVI website and posted to a user's internal http server before performing a Network Upgrade. Refer to Network Tile for additional information.

4.15.2.B Upgrade Software Soft Key

The Upgrade Software Soft Key is displayed after the Test Set queries the selected software upgrade source (USB or Network). Pressing the Upgrade Software Soft Key initiates the procedure to install the software files which were downloaded during the USB or Network Upgrade query process.

4.15.3. How to Upgrade Software

Software upgrade procedures may vary from one version of software to another. Information in this section applies to Test Sets which have been upgraded to software version 3.4.0 and later. If your Test Set contains software prior to version 3.4.0 contact VIAVI Customer Service for the appropriate software upgrade procedure.

4.15.3.A Recommended Preliminary Procedures

VIAVI recommends that customers create a backup of the Test Set's internal files (i.e., test scripts, calibration data, stored setup files) prior to performing the Software Upgrade Procedure. Refer to the File Management Tile or contact VIAVI Customer Service for information.

4.15.3.B REQUIRED Preliminary Procedures

- Install any new License (Option) files before beginning the Software Upgrade procedure. Refer to Install New Option License File Procedure for information.
- Restore Factory Defaults before beginning Software Upgrade Procedure. Refer to Restore Factory Default Settings Procedure for information.

4.15.3.B.1 USB Device Upgrade Procedure (CD/DVD source)

- Extract the 3900 Software zip file from CD/DVD to a USB device. Verify extracted files have been placed in root directory named Instrument, subdirectory named 3900 (Instrument\3900). Do not place the Instrument directory in a subdirectory or the software upgrade will fail.
- Proceed to Step 1 of Upgrade Procedure.

4.15.3.B.2 USB Device Upgrade Procedure (website download)

- Go to <https://www.viavisolutions.com/> to download current software version.
- Click on the desired file to download file to a USB device.
- Extract the 3900 Software zip file to a USB device. Verify extracted files have been placed in root directory named Instrument, subdirectory named 3900 (Instrument\3900). Do not place the Instrument directory in a subdirectory or the software upgrade will fail.
- Proceed to Step 1 of Upgrade Procedure.

4.15.3.B.3 Network Upgrade Procedure

The 3900 Network Upgrade feature allows a user to upgrade the Test Set from a local http server. To upgrade from a local http server, 3900 Software must be downloaded from the VIAVI website, then uploaded to the local http server before performing the software upgrade.

- Go to www.viavisolutions.com/ to download current software version.
- Click on the software file to download the file to desired storage location (i.e., a USB device or local directory).
- Extract the 3900 Software zip file to desired storage location. Verify extracted files have been placed in root directory named Instrument, subdirectory named 3900 (Instrument\3900). Do not place the Instrument directory in a subdirectory or the software upgrade will fail.
- Create an Instrument\3900 directory on the local http server. Upload all files located in the extracted Instrument\3900 software directory to the corresponding directory on the local http server.
- Configure the Test Set for downloading software from a Network server to Test Set according to instructions in the section titled Network Tile, Software Update.
- Proceed to Step 1 of Upgrade Procedure.

4.15.3.C Software Upgrade Procedure

STEP	PROCEDURE
1.	This procedure starts at completion of the Restore Factory Defaults process. Test Set should be displaying the Default Tile.

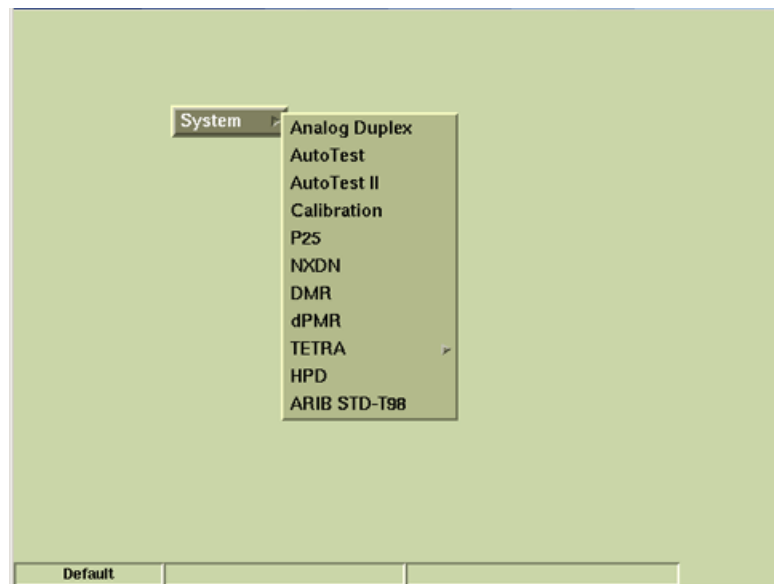

Fig. 4-37 Defaults Tile

2. If performing USB Memory Upgrade, connect USB device to Test Set USB Connector. If performing Network Upgrade, verify Test Set is configured for Network download.
3. Press UTILS Key twice to access Utilities Floating menu. Select Software Settings, Software Upgrade from Utilities Floating menu.
4. Select the Check for Upgrades Soft Key. Select the USB Memory Upgrade or Network Upgrade Soft Key based on type of upgrade being performed.
5. Wait while the Test Set auto-copies files to the unit. This may take several minutes. Do not interrupt this process or the upgrade will fail.
6. When the copy process is complete, if new software is available to install a prompt is displayed to confirm and initiate the upgrade process.

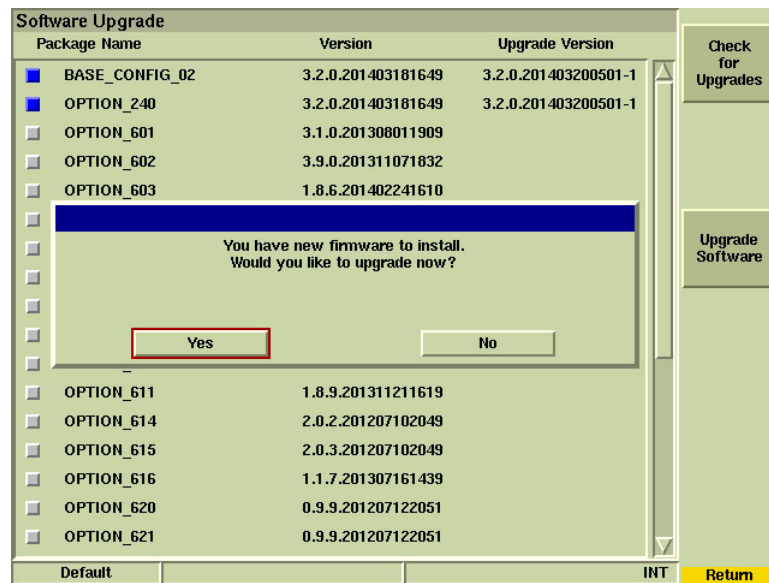

Fig. 4-38 Software Upgrade - Confirm Upgrade Process

7. The remainder of the software upgrade process is automated. DO NOT interrupt this process or the upgrade will fail.
8. When the upgrade is complete the Test Set automatically powers down.
9. If performing USB Memory Upgrade, remove USB device from Test Set.
10. Power on Test Set. Wait while Test Set loads the last selected Operating System.
11. Press the UTILS Key. Test Set should display the Software Upgrade Tile. If the Software Upgrade Tile is not displayed, press the UTILS Key again and select Software Settings, Software Upgrade from the Utility Floating menu.
12. Verify the Version column matches version of software which was installed in the Test Set.

4.16 STORE/RECALL TILE

The Store/Recall Tile is used to save Test Set settings and test results in file formats that can be recalled for later use or exported to a USB device using the File Management Tile. Software Version 1.7.1 introduced Sample file setups for general test scenarios.

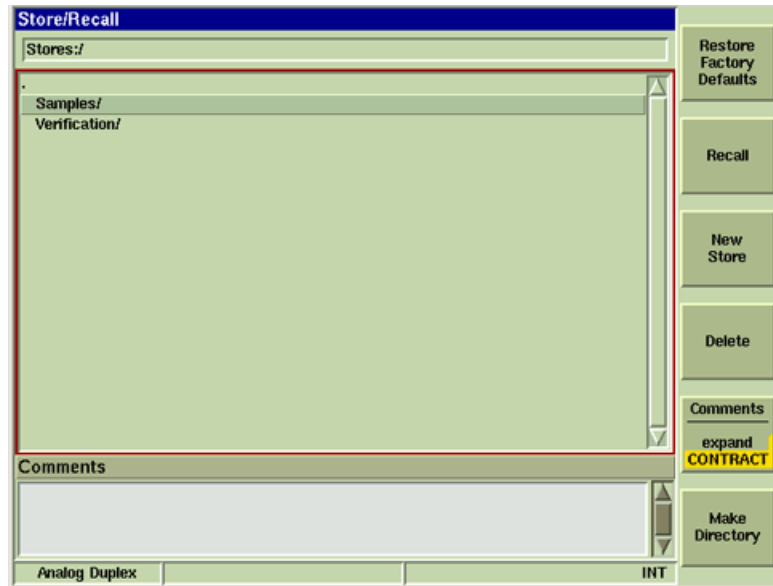

Fig. 4-39 Accessing Store/Recall Tile

Fig. 4-40 shows the soft keys associated with the main Save/Recall Tile.

- The Directory Title bar displays the selected directory.
- The Information Display Tile displays the files and any sub-directories located in the selected directory.
- The Comments Field displays comments with the selected file.

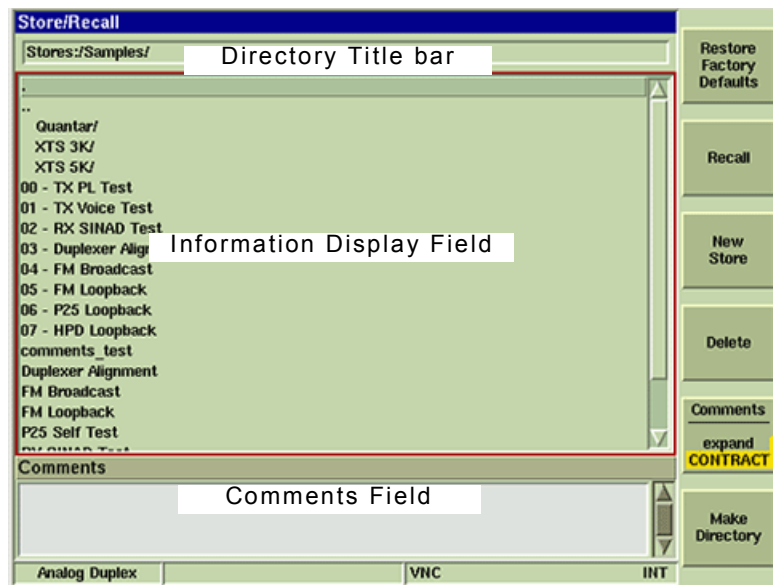

Fig. 4-40 Save/Recall Tile

4.16.1. Soft Key Definitions

4.16.1.A Restore Factory Defaults Soft Key

The Restore Factory Defaults Soft Key recalls the factory defaults for the Test Set.

4.16.1.B Recall Soft Key

The Recall Soft Key retrieves settings for the selected file. A file may also be recalled by double-clicking on a file name when using a USB mouse.

4.16.1.C New Store Soft Key

The New Store Soft Key opens the Store/Recall - New Store Tile which allows the user to save the existing Test Set configuration as a new file.

4.16.1.D Delete Soft Key

The Delete Soft Key erases the selected file from Test Set's internal memory. The action is protected by a second level of soft keys asking user to Confirm or Cancel the action.

4.16.1.E Make Directory Soft Key

The Make Directory Soft Key allows the user to create a new directory (sub-directory) in which to store files.

4.16.1.F Accept Soft Key

The Accept Soft Key is displayed when creating a new settings file. Pressing this key accepts the defined file parameters when creating a new file.

4.16.1.G Clear Comment Soft Key

The Clear Comment Soft Key clears any text present in the Comments field when the field is selected.

4.16.1.H Cancel Soft Key

The Cancel Soft Key terminates the current action. This soft key is accessed by pressing the New Store Soft Key, Make Directory and Delete Soft Key.

4.16.1.I Store Soft Key

The Store Soft Key saves a new file to Test Set's internal memory. This soft key is accessed by pressing the New Store Soft Key.

4.16.1.J Overwrite Soft Key

The Overwrite Soft Key serves as a protective step when saving a settings file. When a file is being saved that has the same name as an existing file, pressing the Overwrite Soft Key replaces the existing file with the new settings: existing file is overwritten and can not be retrieved.

4.16.1.K Comments Soft Key

The Comment Soft Key expands and contracts the Comments field. When the field is expanded fourteen lines of text are visible. When the field is contracted four lines of text are visible. The scroll bar on the Comments field is only accessible using a mouse.

4.16.2. Managing Files

4.16.2.A Creating a Settings File

To save a file setup:

STEP	PROCEDURE
------	-----------

1. With Store/Recall Tile enabled, press New Store Soft Key.
2. Enter the filename in Title bar and comments (if desired) in Comment field.
3. If no comments are to be entered, press the Store Soft Key to save file.
4. If comments have been entered, press the Accept Soft Key to save file.
5. File appears in the list on the Store/Recall Tile.

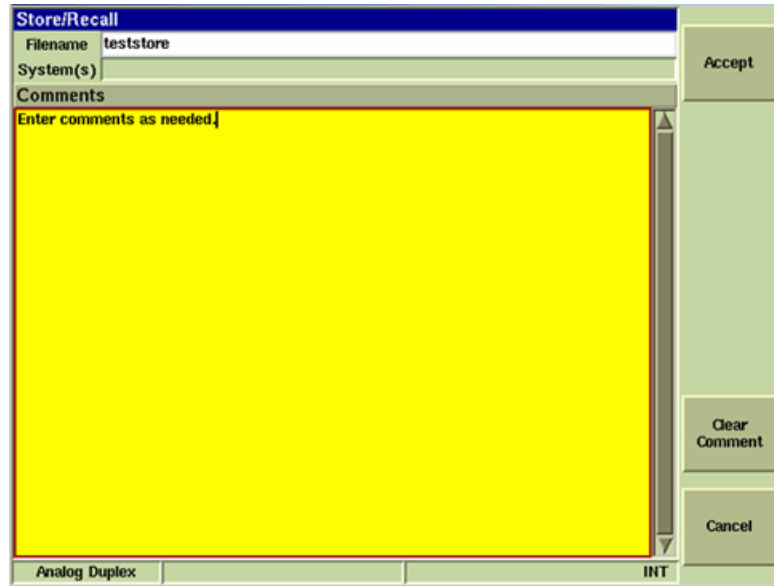

Fig. 4-41 Creating a Settings File

4.16.2.B Recalling Settings

To recall a stored settings file:

STEP PROCEDURE

1. With Store/Recall Tile enabled, highlight desired file.
2. Press the Recall Soft Key or SELECT Key to initiate the recall procedure. During the recall process a message is displayed as shown in the example below. When the file is loaded, all of the Systems in the Test Set are loaded with the Settings contained in the file.

NOTE If using a USB Mouse, double click the desired file to recall the settings.

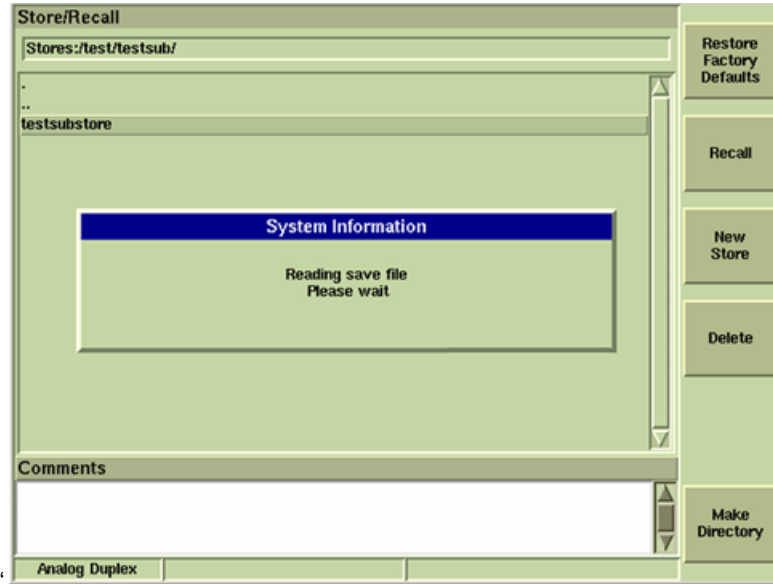

Fig. 4-42 Store/Recall Dialog Box

4.16.2.C Creating New Directory

To create a new Store/Recall Directory:

STEP PROCEDURE

1. Select Store/Recall from the UTILS menu.
2. Select Make Directory Soft Key.
3. Enter directory name in title field and press Make Directory Soft Key.

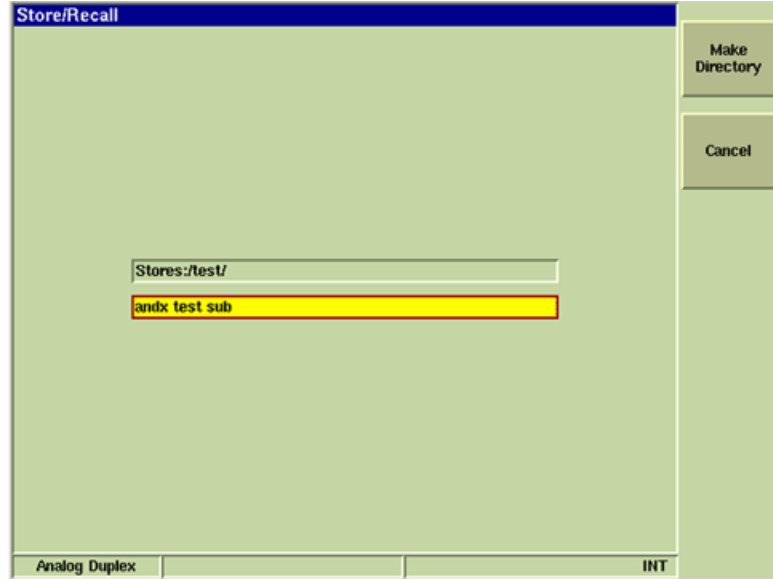

Fig. 4-43 Creating New Directory

4.16.3. Numeric Indexing

The Store/Recall function includes numeric indexing which allows the user to quickly recall stored files. Numeric indexes can be assigned to directories, subdirectories and individual files.

To use this feature, directories and files must contain a numeric index at the beginning of file name. The Store/Recall Tile must be selected to recall files using index numbers.

The following format rules apply when using numeric indexes:

- Alpha characters are invalid and can not be used with the indexing feature.
- Numeric indexes must be two digits(i.e., 01).
- System does not require a space between the index numbers and the file name, but for readability, recommend using nn - File name format.

4.17 USER CALIBRATION TILE

The User Calibration procedure recalculates the compensation required to maintain level accuracy. User Calibration does not replace the System Verification/Calibration procedure.

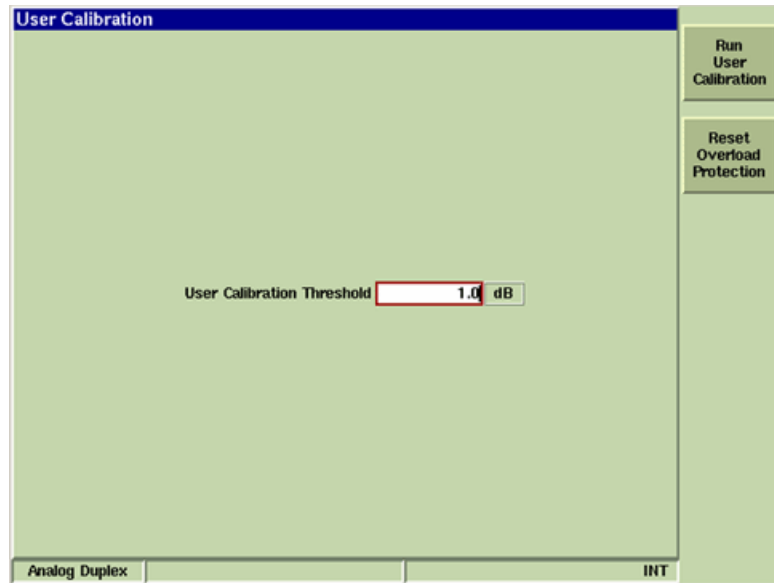

Fig. 4-44 UTILS User Calibration Tile

4.17.1. Field/Soft Key Definitions

4.17.1.A User Calibration Threshold

The User Calibration Threshold field indicates the tolerated amount of error due to temperature drift. For example, if the threshold value is set to 1 dB, the Test Set generates an error message when the accuracy of measured power readings is greater than 1 dB.

4.17.1.B Run User Calibration Soft Key

Pressing the Run User Calibration Soft Key initiates the User Calibration Procedure. The User Calibration Procedure should be performed when the calibration indicator appears at the bottom of the display tile.

4.17.1.C Reset Overload Protection Soft Key

The Reset Overload Soft Key resets the Test Set's input overload relay. When input exceeds maximum levels, the Test Set generates an audible alarm tone. The alarm tone stops when the overload input is disconnected from the Test Set, however, this soft key must be pressed to reset the Test Set's overload warning system.

Refer to 3900 Platform Specifications for maximum input levels.

4.17.2. Run User Calibration Procedure

To run User Calibration Procedure while operating in Test Mode:

STEP

PROCEDURE

1. Disconnect any leads from the Test Set's front panel.
2. Press the UTILS Key twice to access the Utilities menu.
3. Select User Calibration from the Utilities menu.
4. Select Run User Calibration soft key on the User Calibration Tile.
5. When User Calibration is complete, press TEST Key to return to previous operating system.

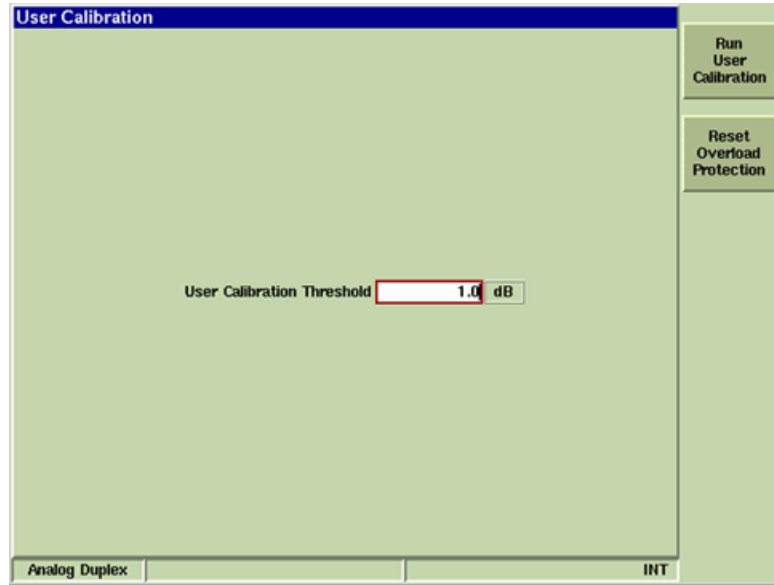

Fig. 4-45 User Calibration Tile

Chapter 5 - AutoTest II System Operation

5.1 INTRODUCTION

The 3900 AutoTest II System is an optional system that builds upon the 3900's remote command structure by using a Tcl interpreter to create an interface between the Test Set's autotest and remote command functions. AutoTest II System command structure includes the use of 3900 remote commands and conventional Tcl commands.

5.2 AUTOTEST II COMMAND STRUCTURE

5.2.1 TCL Commands and Programming Structure

Tcl (Tool Command Language) is an open-source, interpreted programming language that provides common facilities such as variables, procedures and control structures for creating command scripts. AutoTest II also allows the user to use the TK Tool set to build custom user screens. Users must be familiar with Tcl /TK programming command structure to use the AutoTest II System.

Sources for information about Tcl/TK:

For information on Tcl commands, refer to <http://ttml.sourceforge.net/doc/tcl/index.html>.

For information on Tcl/TK programming, refer to <http://ttml.sourceforge.net/doc/tk/>.

Technical Application Note: Tcl Basics (located on 3900 Series Operation CD)

5.2.2 3900 Remote Commands

3900 Remote Programming Commands are documented in the 3900 Series Remote Programming Manual and associated Option(s) Remote Programming Manuals. Refer to the appropriate remote programming manual for programming structure and commands. To utilize remote programming commands in AutoTest II, begin command lines with the Tcl procedure command "rc". Refer to Fig. 5-1 for an example.

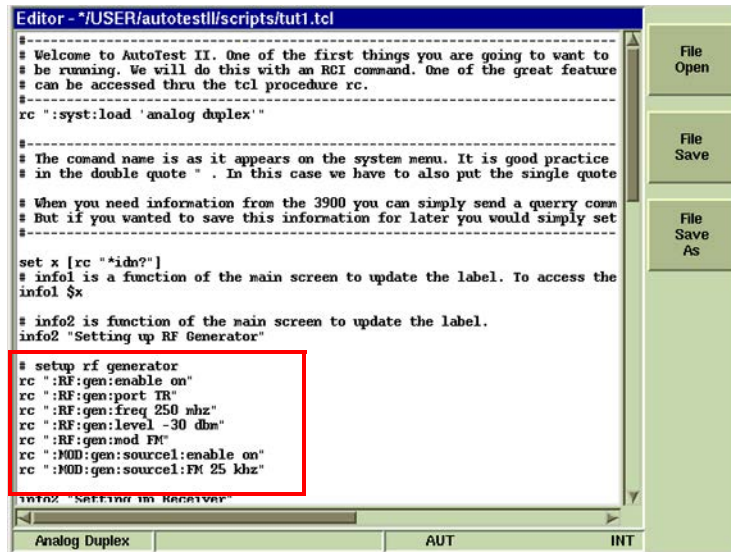

```
Editor - "/USER/autotestII/scripts/tut1.tcl"
#-----
# Welcome to AutoTest II. One of the first things you are going to want to
# be running. We will do this with an RCI command. One of the great feature
# can be accessed thru the tcl procedure rc.
#-----
rc ":syst:load 'analog duplex'"
#-----
# The comand name is as it appears on the system menu. It is good practice
# in the double quote ". In this case we have to also put the single quote
# When you need information from the 3900 you can simply send a query com
# But if you wanted to save this information for later you would simply set
#-----
set x [rc "idn?"]
# info1 is a function of the main screen to update the label. To access the
info1 $x
# info2 is function of the main screen to update the label.
info2 "Setting up RF Generator"
# setup rf generator
rc ":RF:gen:enable on"
rc ":RF:gen:port TR"
rc ":RF:gen:freq 250 mhz"
rc ":RF:gen:level -30 dbm"
rc ":RF:gen:mod FM"
rc ":MOD:gen:sourcel:enable on"
rc ":MOD:gen:sourcel:FK 25 khz"
info2 "Setting up Receiver"
-----
Analog Duplex      AUT      INT
```

Fig. 5-1 Use of rc in AutoTest II Script

5.3 SELECTING AUTOTEST II SYSTEM

The 3900 AutoTest II System is selected from the Test Set's Configuration Floating Menu. To select AutoTest II while operating in Test Mode:

STEP	PROCEDURE
------	-----------

1. Press CONFIG Key twice to access the CONFIG Floating menu.
2. Select Systems, AutoTest II from the CONFIG Floating Menu.
3. AutoTest II loads to display the main tile as shown below (Fig. 5-2).

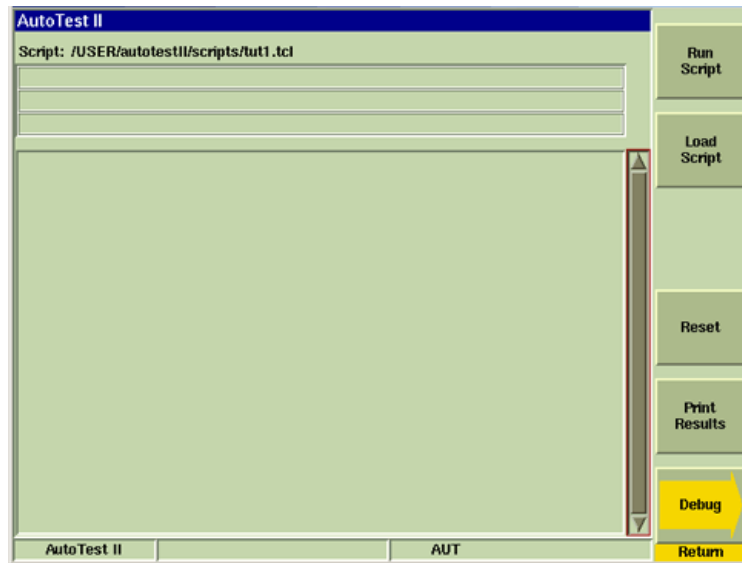

Fig. 5-2 AutoTest II Main Tile

AutoTest II is only available when the corresponding System AutoTest II Option is installed in the Test Set. For example, if a script is intended to test a P25 Trunked radio, the P25 Trunking Option must be installed in the Test Set. Refer to [Appendix F, Optional Test Systems and Functions](#) for list of systems that support the AutoTest II option.

5.4 LOADING AUTOTEST II SCRIPTS

An AutoTest II script must be loaded into the Test Set in order to load and run the script. Refer to [Chapter 4, Test Set Utility Tiles, File Management Tile \(4.6\)](#) for information about transferring scripts to the Test Set.

To load an AutoTest II Test Script:

STEP	PROCEDURE
------	-----------

1. Load AutoTest II System.
2. Press Load Script Soft Key to open File Directory Dialog box.
3. Select desired test script. Verify file name appears in the File field at the bottom of the dialog box.
4. Press OK Soft Key.
5. Verify selected script name is displayed in the Script Title Bar. Press Run Script Soft Key.

5.5 EXITING AUTOTEST II

AutoTest II is exited by selecting a different operating system from the CONFIG, Systems menu.

To exit AutoTest II:

STEP	PROCEDURE
------	-----------

1. Press CONFIG Key.
2. Select the desired operating system from the Systems menu.

5.6 AUTOTEST II FILE NAME FORMAT

AutoTest II supports test scripts with .tcl file extension. Do not include spaces in AutoTest II file names.

5.7 AUTOTEST II TILE COMPONENTS

The AutoTest II Tile contains the Script title bar, three information bars, the results display area and the soft key area.

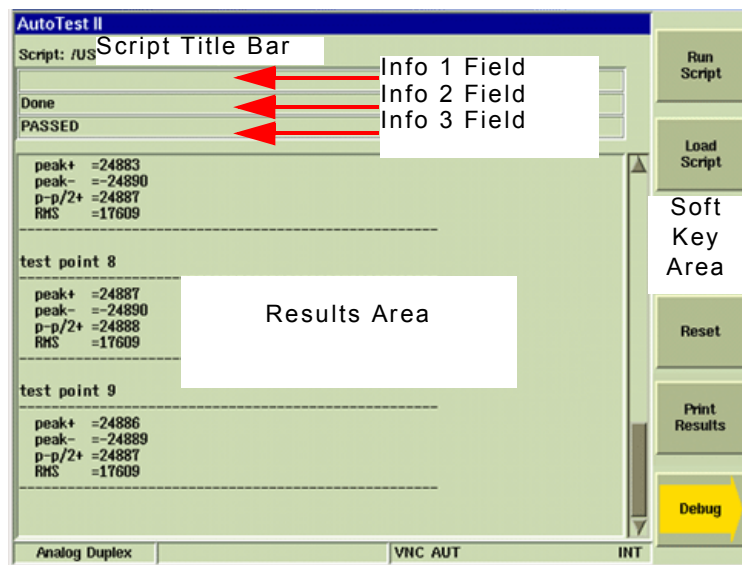

Fig. 5-3 AutoTest II Tile Layout

5.7.1 Field/Soft Key Definitions

5.7.1.A Script Title Bar

The title bar lists the last loaded script file. A script file does not need to be reloaded to run the last loaded test script. If the desired test script is already loaded, press Run Script Soft Key to run the script.

5.7.1.B Information Fields

The Information fields display various status messages before, during and after a test script is run. Fields are referred to in command structure as “info1”, “info2”, “info3”.

5.7.1.C Results Display Area

The Results Display Area shows results of completed tests as well as any user prompts that are included in a test script. The Results Display Area is referred to in command structure as ‘results’.

5.7.1.D Run Script Soft Key

The Run Script Soft Key runs loaded AutoTest II script.

5.7.1.E Load Script Soft Key

The Load Script Soft Key loads selected AutoTest II script.

5.7.1.F Reset Soft Key

The Reset Soft Key clears data from Main AutoTest II screen and also clears data from User Screen or Debug screen.

5.7.1.G Print Results Soft Key

Sends AutoTest results to configured printer. Printer must be configured on Printer Configuration Tile to use this function.

5.7.1.H Debug Soft Key

The Debug Soft Key opens a 'work area' where users can test and validate tcl commands or run remote commands to review the type of data that is returned. The Debug feature provides feedback when tcl or remote commands are invalid.

The example below shows an error message that was received when the remote command :CONF:MOD:ANAL:AM:AVER was entered. The command was invalid because it did not end with a query indicator (:CONF:MOD:ANAL:AM:AVER?) or value (:CONF:MOD:ANAL:AM:AVER 10).

NOTE	Use the 'print' command to display information on the Debug Screen; do not use the 'puts' command as this command is reserved for file access.
-------------	--

Example:

```
set a "TEST"
puts $1 <- invalid AutoTest II command
print $2 <- valid AutoTest II command
```

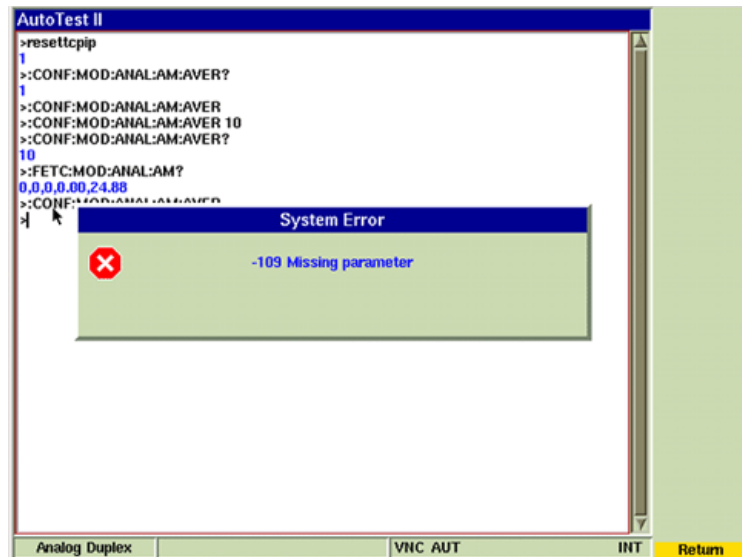

Fig. 5-4 Remote Command Validation

5.7.1.I Continue Soft Key

The Continue Soft Key advances to the next step in the AutoTest script.

5.7.1.J Abort Soft Key

The Abort Soft Key cancels the current action.

5.8 AUTOTEST II CONFIGURATION TILE

The AutoTest II Configuration Tile contains data fields that allow the user to enter information that appears in completed test data. These parameters should be defined prior to running the script.

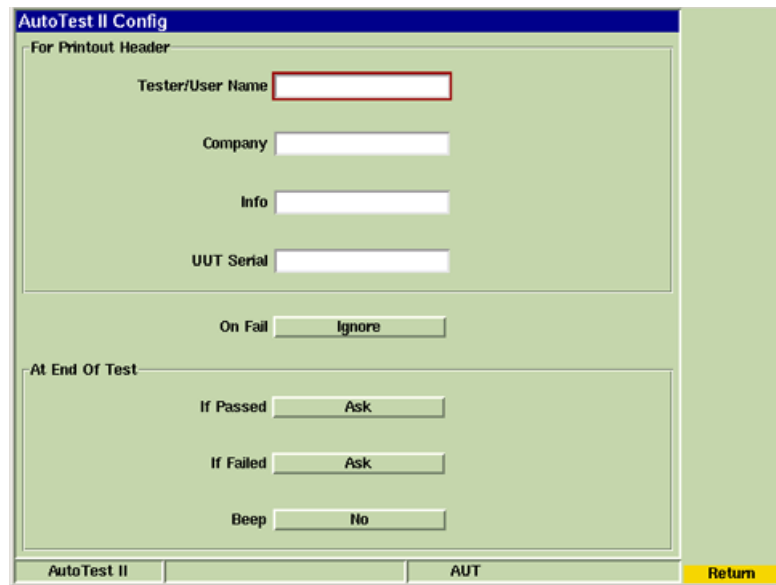

Fig. 5-5 AutoTest II Configuration Tile

5.8.1 Field Definitions

5.8.1.A For Printout Header Section

Information entered in this section of the AutoTest configuration Tile appears on the header of printed test data. These are not required data fields. Data fields allow the Test/User Name, company name, Information about the test, and serial number of the unit under test to be defined.

5.8.1.B On Fail

Defines the action the Test Set performs when a portion of a test sequence fails. Options are Pause, Abort or Ignore.

5.8.1.C At End of Test Section

5.8.1.C.1 If Passed

Defines the action the Test Set performs when a completed test passes defined criteria.

5.8.1.C.2 If Failed

Defines the action the Test Set performs when a completed test fails defined criteria.

5.8.1.C.3 Beep Button

The Beep toggle button Enables/Disables audible beep that indicates when a test is complete.

5.9 EDITOR MODE

AutoTest II contains an editing mode that allows the user to review and make minor changes to an imported Test Script.

Editor Mode has been developed primarily as a viewing application within AutoTest II Systems, however, the tool does function as a basic editing tool.

Edited script files can be saved over existing files or renamed with a new file name. Edited files can be exported using the File Management feature.

NOTE

Editor Mode requires use of an external keyboard; Editor Mode does not support advanced keyboard functionality (i.e., using the Ctrl+Alt+c key combination to copy text); Use of a USB mouse is recommended when using Editor Mode.

5.9.1 Accessing Editor Mode

To access Editor Mode:

STEP	PROCEDURE
------	-----------

1. Press the TEST Key on Test Set.
2. Select Editor from TEST floating menu.

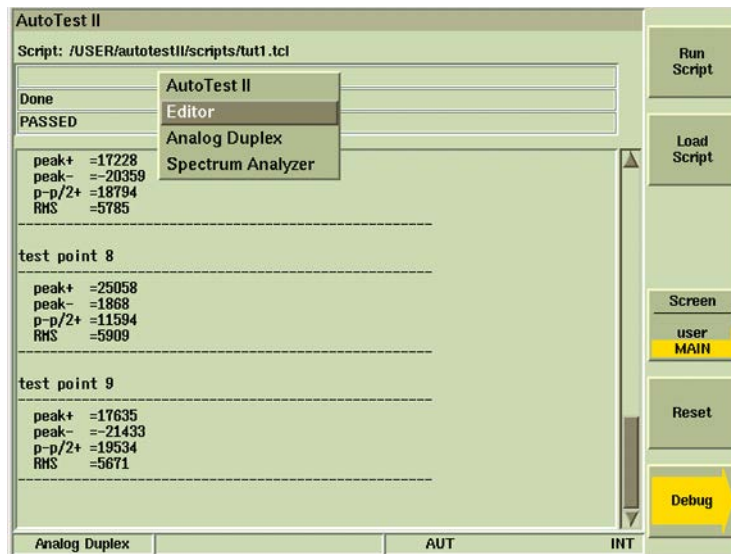

Fig. 5-6 Accessing AutoTest II Editor Tool

3. The last viewed file is displayed when Editor Mode is selected. Press File Open Soft Key.
4. When File Open dialog box opens, open the results/ or scripts/ directory and select desired file.
5. Verify the selected file name appears in the File field and press the OK Soft Key.

6. The screen displays contents of selected file as shown in example below.

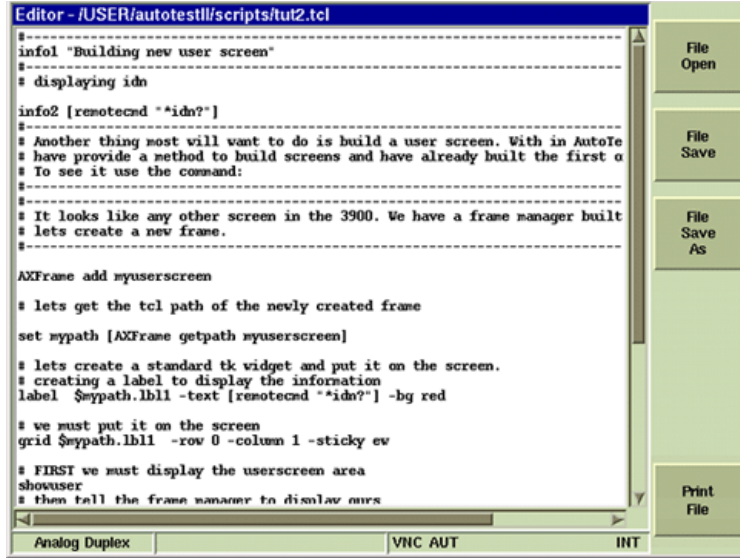

Fig. 5-7 Script File in Editor Mode

5.10 AUTOTEST II SYSTEM OPTIONAL TEST SCRIPTS

The 3900 has optional automated test scripts available which utilize the 3900 AutoTest II System. When a test script option is installed in the Test Set the main AutoTest II Tile layout updates to display Script Button(s) on the main tile. Fig. 5-8 shows the Test Set with several Script Buttons enabled. Pressing a Script Button loads the selected pre-defined automated test script.

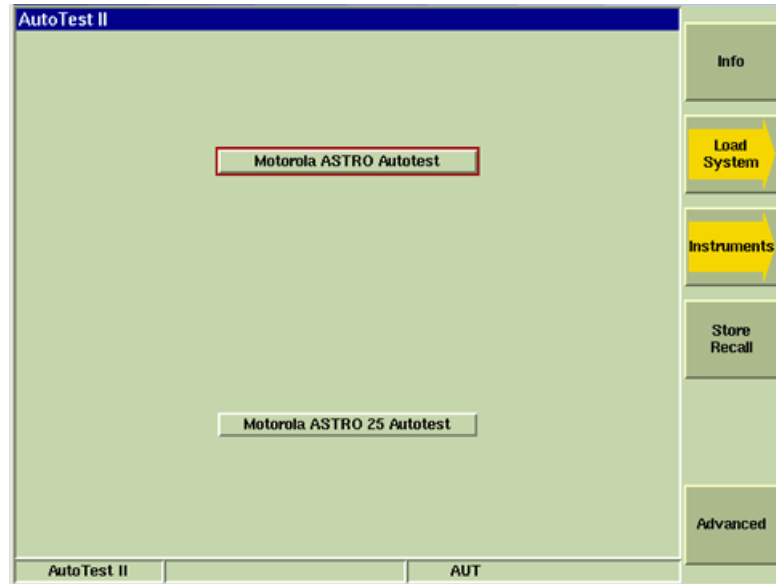

Fig. 5-8 AutoTest II - Script Option Buttons

5.10.1 Info Soft Key

Pressing the Info Soft Key displays information about the test script. The section can be used to identify the radios the test script supports, the hardware needed to complete the test and Test Set options required to run the test script.

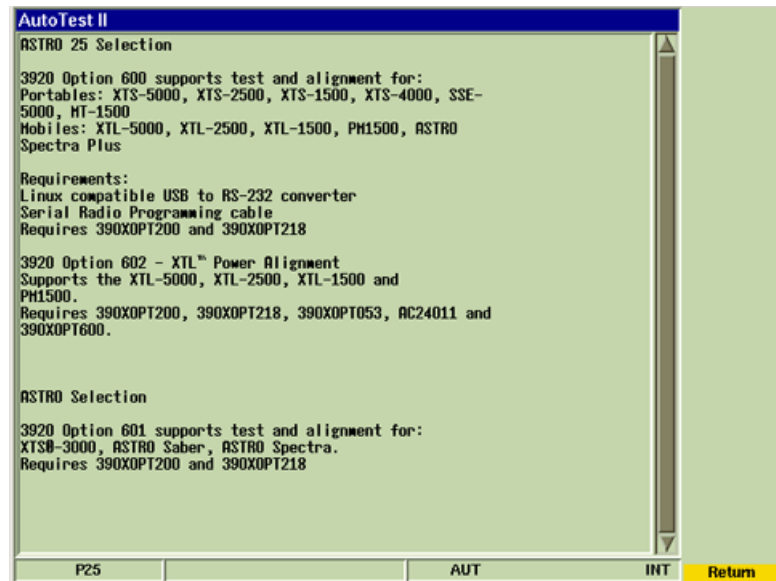

Fig. 5-9 Information Tile Example - Motorola ASTRO P25 Autotest

5.10.2 Load System Soft Key

Pressing this soft key accesses soft keys which allow the user to load a specified system within AutoTest II. These soft keys do not exit the AutoTest II System.

5.10.3 Instruments Soft Key

Pressing this soft key accesses soft keys which allow the user to load an instrument within AutoTest II. These soft keys do not exit the AutoTest II System.

5.10.4 Store Recall Soft Key

Pressing this soft key allows the user to access the Test Set's internal database to store or recall script files and results. Refer to Store/Recall Tile in Chapter 4 for information on using the Store/Recall Utility.

5.10.5 Advanced Soft Key

Pressing this soft key updates the display so that it resembles the tile layout of the based AutoTest II System (without optional scripts installed).

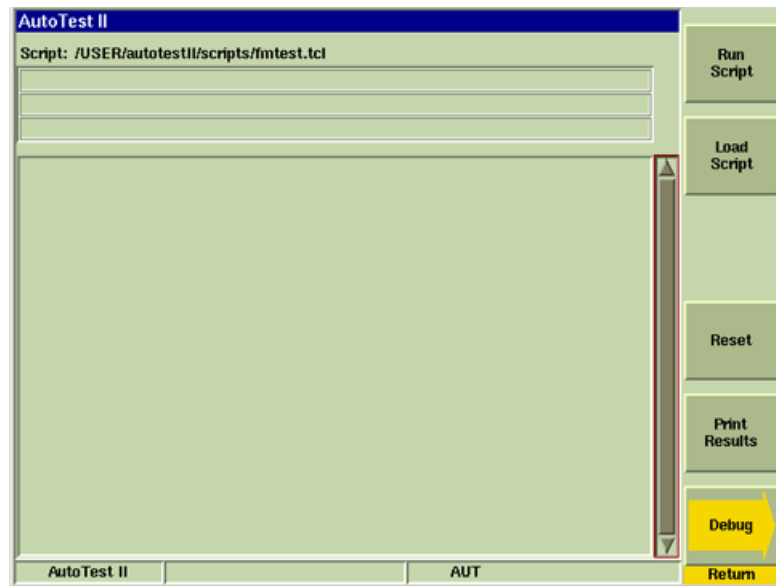

Fig. 5-10 AutoTest II System - Advanced Tile

5.10.6 Debug Soft Key

Refer to section titled AutoTest II Tile Components for use of the Debug Soft Key.

5.10.7 Return

When a test system such as Analog Duplex is loaded from within the AutoTest II System, pressing Return displays the AutoTest II Main Tile.

5.11 AUTOTEST II TUTORIALS

AutoTest II contains several tutorial test scripts that provide guidelines on creating test scripts. Tutorial scripts are accessed using Editor Mode.

5.11.1 tut1.tcl (Tutorial 1)

Includes examples of the following:

- Loading a 3900 system
- Setting up RF Generator
- Setting up Receiver
- Saving results to a file

5.11.2 tut2.tcl (Tutorial 2)

Using displayuserentry and displaypicscreen.

5.11.3 tut3.tcl (Tutorial 3)

Using Function Keys and User Message Screen.

5.11.4 tut4.tcl (Tutorial 4)

Using test_audio_level, test_audio_distortion and associated variables.

5.11.5 tut5.tcl (Tutorial 5)

Using test_demod_fm, test_demod_distortion and associated variables.

5.12 MANAGING RESULTS

5.12.1 Storing Results

AutoTest II stores results directly to the Test Set's internal hard drive. Saved test results can then be exported from the Test Set to a USB device using the File Management feature.

5.12.2 Printing Results

AutoTest II test results and test scripts can be printed by pressing the Print Results or Print File Soft Key.

5.13 AUTOTEST II COMMANDS

The following are AutoTest II commands developed to be used with the 3900:

5.13.1 AX

AX is a global variable that allows the user to include various functions in a test script

5.13.1.A ::AX(scriptpath)

Holds the script path /USER/autotestII/scripts

5.13.1.B ::AX(functionkey)

Holds the function key that was pressed (1 - 6). Tutorial 3 (tut3.tcl) provides information on using function keys.

5.13.1.C ::AX(abortproc)

Holds the name of the user abort procedure; the command is executed when Abort Soft Key is pressed during script execution.

5.13.1.D ::AX(debug)

1 or 0; if set to '0', debugstep statements are activated

5.13.2 delay “time - in milliseconds” “usrmsg - string”

Pauses execution of script for 1 seconds and displays user message in title bar Information area.

Limited to 24 characters in length.

Example:

```
delay 1000 “waiting for reading”
```

5.13.3 print “string”

Prints “The Test has Passed” in the Results area when test is complete and has passed requirements.

Example:

```
print “The Test has Passed”
```

5.13.4 beep

Makes Test Set generate a short audio tone. Command usage would be to indicate the end of a test script or to indicate when user action is required.

5.13.5 rc “string”

Remote command access: must be included in front of RCI command when remote commands are used in test script.

Example:

```
rc “*idn?”
```

Reads Test Set information: Manufacturer, model, serial number, software issue number

```
VIAMI,3901,297001018,1.6.0
```

Example:

```
print [rc “CONF:MOD:ANA:FREQ:AVER?”]
```

Prints value returned from the :CONF:MOD:ANA:FREQ:AVER? command in the results area.

Example:

```
set reply [rc “*idn?”]
```

Includes value returned from the *idn? command in the variable reply.

5.13.6 clearresults

Clears Results Area on display tile.

5.13.7 clearscreen

Clears all data on display tile, including data in the Info 1, 2 and 3 fields as well as the Results Area.

5.13.8 info1, info2, info3

Commands insert text into the corresponding data field on the display tile.

Example:

```
info1 “Setting up RF Generator”
```

```
info2 “ “
```

```
info3 “ “
```

5.13.9 abort

Stops execution of the script and returns to the main test screen.

5.13.10 openprintfile

Opens designated file in the results directory for editing purposes.

Example:

```
openprintfile “tut1results.rts”
```

5.13.11 writeprintfile

Writes data to the file and prints it to the results area.

Example:

```
writeprintfile “-----”
```

```
writeprintfile “ peak+ = [index $templist 4]”
```

```
writeprintfile “ peak- = [index $templist 5]”
```

```
writeprintfile “ p-p/2+ = [index $templist 3]”
```

```
writeprintfile “ RMS = [index $templist 6]”
```

```
writeprintfile “-----”
```

```
writeprintfile “ “
```

5.13.12 closeprintfile

Closes previously opened file.

5.13.13 printfile

Sends file to printer. Must have printer configured (UTILS function) to use this command.

Example:

```
printfile "tut1results.rts"
```

5.13.14 resettcpip

Resets the tcpip server and opens a new network socket for RCI communications.

5.13.15 readch

Reads the tcpip socket for results.

5.13.16 showmain

Shows the AutoTest II Main Tile.

5.13.17 showuser

Shows the AutoTest II User Tile.

5.13.18 setcustom

Configures soft keys used throughout test script.

Example:

```
setcustom 1 "Custom 1"  
setcustom 2 "Custom 2"  
setcustom 3 "Custom 3"  
setcustom 4 "Custom 4"  
setcustom 5 "Custom 5"  
setcustom 6 "Custom 6"
```

5.13.19 showcustom

Displays a set of custom soft keys and pauses script while waiting for user to make soft key selection. Script resumes running when soft key is pressed.

::AX(functionkey) variable command indicates the soft key that was pressed.

Example:

```
if { $::AX(functionkey) == 1 } {  
    print "Key 1 was pressed"  
}
```

5.13.20 clearcustom

Clears custom message area. Clears all configuration for custom soft key set.

5.13.21 pause

Pauses script and displays soft key set:

- 1 - Continue (allows script to continue)
- 2 - Abort (stops script and returns to AutoTest II Main Tile)

5.13.22 **pauseFRA**

Pauses script and displays soft key set. Script returns which soft key was pressed.

- 1 - Fail
- 2 - Retry
- 3 - Abort (stops script and returns to AutoTest II Main Tile)

Example:

```
set temp [pauseFRA]
if { $temp ==1 } {
    print "Fail was pressed"
} elseif { $temp == 2 }
    print "Retry was pressed"
}
```

5.13.23 **pauseYN**

Pauses script and displays soft key set:

- 1 - Yes
- 2 - No

Example:

```
set temp [pauseYN]
if { $temp ==1 } {
    print "Yes was pressed"
} else {
    print "No was pressed"
}
```

5.13.24 **addusermsg "string"**

Displays message on User Screen. Tutorial 3 (tut3.tcl) provides information on using User Message Screen.

5.13.25 **clearusermsg**

Clears custom message area.

5.13.26 **displayusermsg**

Displays User Screen. Tutorial 3 (tut3.tcl) provides information on using User Message Screen.

Example:

```
clearusermsg
addusermsg "User Instruction"
addusermsg " "
addusermsg "Pause command example"
displayusermsg
```

pause

showmain (You must use the showmain command to return to the Main Screen)

5.13.27 displayuserentry “string”

Displays the screen with an entry for the user to enter text and the message “string.” Tutorial 2 (tut2.tcl) provides information on using displayuserentry.

Example:

```
displayuserentry “Enter the user Data”
```

5.13.28 displaypicscreen “string” “file name”

Displays a screen containing an .xbm or .gif image and text at the bottom. Tutorial 2 (tut2.tcl) provides information on using displaypicscreen.

Example:

```
displaypicscreen “This is a TEST” [file join $::AX(scriptpath) test.gif]
```

5.13.29 debugstep “mode” “string”

Debugs AutoTest II test scripts. `::AX(debug)` must be set to 1 for this command to be executed.

5.13.29.A mode=1

Prints debug command and pauses script.

5.13.29.B mode=0

Prints debug command and continues script.

5.13.30 AutoTest to Tcl Command

The following table provides a conversion guide for replacing AutoTest commands with Tcl Commands..

AutoTest Command	Tcl Command
IF	IF
repeat	for/next loop
result_print	print
wait	delay

5.14 TEST FUNCTIONS AND VARIABLES

This section lists Meter test functions and the variables associated with each function. These test functions are only valid in the Analog Duplex System.

5.14.1 Using Functions

5.14.1.A **test_demod_am**

demod_am(avgcnt)
demod_am(average)
demod_am(units)
demod_am(ulimit)
demod_am(llimit)
demod_am(passfail)

5.14.1.B **test_demod_fm**

demod_fm(avgcnt)
demod_fm(average)
demod_fm(rms)
demod_fm(units)
demod_fm(ulimit)
demod_fm(llimit)
demod_fm(passfail)

5.14.1.C **test_demod_frequency**

demod_freq(avgcnt)
demod_freq(average)
demod_freq(units)
demod_freq(ulimit)
demod_freq(llimit)
demod_freq(passfail)

5.14.1.D **test_demod_distortion**

demod_dist(avgcnt)
demod_dist(average)
demod_dist(units)
demod_dist(ulimit)
demod_dist(passfail)

5.14.1.E **test_demod_hn**

demod_hn(avgcnt)
demod_hn(average)
demod_hn(units)
demod_hn(llimit)
demod_hn(passfail)

5.14.1.F test_demod_sinad

demod_sinad(avgcnt)
demod_sinad(average)
demod_sinad(units)
demod_sinad(llimit)
demod_sinad(passfail)

5.14.1.G test_demod_snr

demod_snr(avgcnt)
demod_snr(average)
demod_snr(units)
demod_snr(llimit)
demod_snr(passfail)

5.14.1.H test_aib_power

aib_pwr(avgcnt)
aib_pwr(average)
aib_pwr(units)
aib_pwr(ulimit)
aib_pwr(llimit)
aib_pwr(passfail)

5.14.1.I test_audio_frequency

audio_freq(avgcnt)
audio_freq(average)
audio_freq(units)
audio_freq(ulimit)
audio_freq(llimit)
audio_freq(passfail)

5.14.1.J test_audio_distortion

audio_dist(avgcnt)
audio_dist(average)
audio_dist(units)
audio_dist(ulimit)
audio_dist(passfail)

5.14.1.K test_audio_hn

audio_hn(avgcnt)
audio_hn(average)
audio_hn(units)
audio_hn(llimit)
audio_hn(passfail)

5.14.1.L test_audio_level

audio_level(avgcnt)
audio_level(average)
audio_level(units)
audio_level(ulimit)
audio_level(llimit)
audio_level(passfail)

5.14.1.M test_audio_sinad

audio_sinad(avgcnt)
audio_sinad(average)
audio_sinad(units)
audio_sinad(llimit)
audio_sinad(passfail)

5.14.1.N test_audio_snr

audio_snr(avgcnt)
audio_snr(average)
audio_snr(units)
audio_snr(llimit)
audio_snr(passfail)

5.14.1.O test_trbb_power

trbb_pwr(avgcnt)
trbb_pwr(average)
trbb_pwr(units)
trbb_pwr(ulimit)
trbb_pwr(llimit)
trbb_pwr(passfail)

5.14.1.P test_freq_error

rf_err(avgcnt)
rf_err(average)
rf_err(res)
rf_err(units)
rf_err(ulimit)
rf_err(passfail)

5.14.1.Q test_trib_power

trib_pwr(avgcnt)
trib_pwr(average)
trib_pwr(units)
trib_pwr(ulimit)
trib_pwr(llimit)
trib_pwr(passfail)

5.14.2 Using Variables

There are several variables associated with each meter test function. This section describes the function of each variable.

5.14.2.A avgcnt variables

These variables set the average count of the meter being read. If the user does not set the avgcnt variable, it defaults to 1.

demod_am(avgcnt)
demod_fm(avgcnt)
demod_freq(avgcnt)
demod_dist(avgcnt)
demod_hn(avgcnt)
demod_sinad(avgcnt)
demod_snr(avgcnt)
aib_pwr(avgcnt)
audio_freq(avgcnt)
audio_dist(avgcnt)
audio_hn(avgcnt)
audio_level(avgcnt)
audio_sinad(avgcnt)
audio_snr(avgcnt)
trbb_pwr(avgcnt)
rf_err(avgcnt)
trib_pwr(avgcnt)

Example:

```
# set number of averages for demod sinad meter to 10  
set demod_sinad(avgcnt) 10
```

5.14.2.B **average variables**

These variables are set by the corresponding test function. These variables hold the meter reading measured in the test function.

aib_pwr(average)
audio_freq(average)
audio_dist(average)
audio_hn(average)
audio_level(average)
audio_sinad(average)
audio_snr(average)
demod_am(average)
demod_fm(average)
demod_freq(average)
demod_dist(average)
demod_hn(average)
demod_sinad(average)
demod_snr(average)
rf_err(average)
trbb_pwr(average)
trib_pwr(average)

Example

```
# Show the meter reading  
puts "The sinad meter reading was: $demod_sinad(average)"
```

5.14.2.C units variables

User defined variable allows the user to set the units of the meter being tested. Some meters (e.g. the Distortion Meter) have fixed units and will not be modified.

```
demod_am(units)
demod_fm(units)
demod_freq(units)
demod_dist(units)
demod_hn(units)
demod_sinad(units)
demod_snr(units)
aib_pwr(units)
audio_freq(units)
audio_dist(units)
audio_hn(units)
audio_level(units)
audio_sinad(units)
audio_snr(units)
trbb_pwr(units)
rf_err(units)
trib_pwr(units)
```

Example:

```
# For the next meter test, set the TR inband power meter units to dBm
set trib_pwr(units) "dBm"
```

5.14.2.D ulimit variables

User defined variable allows the user to set the upper limit of the meter being tested.

```
aib_pwr(ulimit)
audio_freq(ulimit)
audio_dist(ulimit)
audio_level(ulimit)
demod_am(ulimit)
demod_fm(ulimit)
demod_freq(ulimit)
demod_dist(ulimit)
rf_err(ulimit)
trbb_pwr(ulimit)
trib_pwr(ulimit)
```

Example:

```
# For the next meter test, set the TR inband power meter units to dBm
set trib_pwr(units) "dBm"
```

5.14.2.E **llimit variables**

User defined variable allows the user to set the lower limit of the meter being tested.

aib_pwr(llimit)
audio_freq(llimit)
audio_hn(llimit)
audio_level(llimit)
audio_sinad(llimit)
audio_snr(llimit)
demod_am(llimit)
demod_fm(llimit)
demod_freq(llimit)
demod_hn(llimit)
demod_sinad(llimit)
demod_snr(llimit)
rf_err(llimit)
trbb_pwr(llimit)
trib_pwr(llimit)

Example:

```
# Set the TR inband power meter lower limit to -20.0  
set trib_pwr(llimit) -20.0
```

5.14.2.F passfail variables

These variables are set by the corresponding test function. The test function compares the meter reading (stored in the average variables) to the limits (stored in the ulimit, and llimit variables), and sets the passfail variable to either the string " PASS ", or the string "**FAIL**".

NOTE

After returning from the test function the user must provide the necessary code to handle the pass/fail conditions. Refer to the AutoTest II tutorials for examples of defining pass/fail conditions.

aib_pwr(passfail)
audio_freq(passfail)
audio_dist(passfail)
audio_hn(passfail)
audio_level(passfail)
audio_sinad(passfail)
audio_snr(passfail)
demod_am(passfail)
demod_fm(passfail)
demod_freq(passfail)
demod_dist(passfail)
demod_hn(passfail)
demod_sinad(passfail)
demod_snr(passfail)
rf_err(passfail)
trbb_pwr(passfail)
trib_pwr(passfail)

Example:

```
# Print the result of the TR inband power meter test
if { $trib_pwr(passfail) == " PASS " } {
  puts "The last power meter test passed!"
} else {
  puts "The last power meter test failed!"
}
```

5.15 AUTOTEST II COMMAND CONVERSION CHART

The following table provides a guide to convert AutoTest Commands that are used in existing AutoTest scripts to commands that are used by AutoTest II System. Updates must be made manually.

AutoTest Command	AutoTest II Command
baud_usb_to_serial	USBTOSER:BAUD
charsize_usb_to_serial	USBTOSER:CHAR
close_usb_to_serial	USBTOSER:CLOSE
hwflowcontrol_usb_to_serial	USBTOSER:HWFL
open_usb_to_serial	USBTOSER:OPEN
parity_usb_to_serial	USBTOSER:PARI
query_usb_to_serial	USBTOSER:QUER?
read_usb_to_serial	USBTOSER:READ?
set_agclevel_mode	RF:ANAL:AGC:MODE
set_agclevel_value	RF:ANAL:AGC:LEV
set_amfmdemod_am_average	CONF:MOD:ANAL:AM:AVER
set_amfmdemod_amdepth_llen	LIM:MOD:AM:LOW:ENAB
set_amfmdemod_amdepth_llimit	LIM:MOD:AM:LOW:VAL
set_amfmdemod_amdepth_ulen	LIM:MOD:AM:UPP:ENAB
set_amfmdemod_amdepth_ulimit	LIM:MOD:AM:UPP:VAL
set_amfmdemod_demodbw	RF:ANAL:FMIF, RF:ANAL:AMIF
set_amfmdemod_demodstate	RF:ANAL:MOD
set_amfmdemod_filter	MOD:ANAL:MFIL
set_amfmdemod_fm_average	CONF:MOD:ANAL:FM:AVER
set_amfmdemod_fm_devtype	CONF:MOD:ANAL:FM:MTYP
set_amfmdemod_fmdev_llen	LIM:MOD:FM:LOW:ENAB
set_amfmdemod_fmdev_llimit	LIM:MOD:FM:LOW:VAL
set_amfmdemod_fmdev_ulen	LIM:MOD:FM:UPP:ENAB
set_amfmdemod_fmdev_ulimit	LIM:MOD:FM:UPP:VAL
set_amfmdemod_fmrms_llen	LIM:MOD:FMRMS:LOW:ENAB
set_amfmdemod_fmrms_llimit	LIM:MOD:FMRMS:LOW:VAL
set_amfmdemod_fmrms_ulen	LIM:MOD:FMRMS:UPP:ENAB
set_amfmdemod_fmrms_ulimit	LIM:MOD:FMRMS:UPP:VAL
set_amfmdemod_freq_average	CONF:MOD:ANAL:FREQ:AVER
set_amfmdemod_psoph_filter	CHANGING TO CONF:MOD:MFIL:TYP
set_amfmmod_distortion_average	CONF:MOD:ANAL:DIST:AVER
set_amfmmod_distortion_ulen	LIM:MOD:DIST:UPP:ENAB
set_amfmmod_distortion_ulimit	LIM:MOD:DIST:UPP:VAL
set_amfmmod_hn_average	CONF:MOD:ANAL:HN:AVER
set_amfmmod_hn_llen	LIM:MOD:HN:LOW:ENAB
set_amfmmod_hn_llimit	LIM:MOD:HN:LOW:VAL
set_amfmmod_hn_lockref	CONF:MOD:ANAL:HN:REF
set_amfmmod_hn_ulen	LIM:MOD:HN:UPP:ENAB
set_amfmmod_hn_ulimit	LIM:MOD:HN:UPP:VAL

AutoTest Command	AutoTest II Command
set_amfmmod_mod0_devper	MOD:GEN:SOUR1:FM, MOD:GEN:SOUR1:AM
set_amfmmod_mod0_enable	MOD:GEN:SOUR1:ENAB
set_amfmmod_mod0_freq	MOD:GEN:SOUR1:SINE:FREQ, MOD:GEN:SOUR1:SQU:FREQ
set_amfmmod_mod0_type	MOD:GEN:SOUR1:SHAP
set_amfmmod_mod1_devper	MOD:GEN:SOUR2:FM, MOD:GEN:SOUR2:AM
set_amfmmod_mod1_enable	MOD:GEN:SOUR2:ENAB
set_amfmmod_mod1_freq	MOD:GEN:SOUR2:SINE:FREQ, MOD:GEN:SOUR2:SQU:FREQ
set_amfmmod_mod1_type	MOD:GEN:SOUR2:SHAP
set_amfmmod_mod2_devper	MOD:GEN:SOUR3:FM, MOD:GEN:SOUR3:AM
set_amfmmod_mod2_enable	MOD:GEN:SOUR3:ENAB
set_amfmmod_mod2_freq	MOD:GEN:SOUR3:SINE:FREQ, MOD:GEN:SOUR3:SQU:FREQ
set_amfmmod_mod2_type	MOD:GEN:SOUR3:SHAP
set_amfmmod_modstate	RF:GEN:MOD
set_amfmmod_sinad_average	CONF:MOD:ANAL:SIN:AVER
set_amfmmod_sinad_llen	LIM:MOD:SIN:LOW:ENAB
set_amfmmod_sinad_llimit	LIM:MOD:SIN:LOW:VAL
set_amfmmod_snr_average	CONF:MOD:ANAL:SNR:AVER
set_amfmmod_snr_llen	LIM:MOD:SNR:LOW:ENAB
set_amfmmod_snr_llimit	LIM:MOD:SNR:LOW:VAL
set_amfmmod_snr_ulen	LIM:MOD:SNR:UPP:ENAB
set_amfmmod_snr_ulimit	LIM:MOD:SNR:UPP:VAL
set_analog_timeout	N/A
set_analyzer_avgenable	CA:TRAC:AVER:ENAB, SA:TRAC:AVER:ENAB
set_analyzer_avgsize	CA:TRAC:AVER:VAL, SA:TRAC:AVER:VAL
set_analyzer_center_freq	CA:HOR:FREQ:CENT, SA:HOR:FREQ:CENT
set_analyzer_centerrel	CA:HOR:FREQ:CENT:REL
set_analyzer_horiz_mode	CA:HOR:MODE, SA:HOR:MODE
set_analyzer_marker_lockmode	CA:MARK:MODE LOCK, SA:MARK:MODE LOCK, CA:MARK:MODE UNL, SA:MARK:MODE UNL
set_analyzer_marker1enable	CA:MARK:MKR1:ENAB, SA:MARK:MKR1:ENAB
set_analyzer_marker1position	CA:MARK:MKR1:POS, SA:MARK:MKR1:POS
set_analyzer_marker1setscf	CA:MARK:MKR1:SCF, SA:MARK:MKR1:SCF
set_analyzer_marker1setsleft	CA:MARK:MKR1:LEFT, SA:MARK:MKR1:LEFT

AutoTest Command	AutoTest II Command
set_analyzer_marker1setsref	CA:MARK:MKR1:SREF, SA:MARK:MKR1:SREF
set_analyzer_marker1setsright	CA:MARK:MKR1:RIGHT, SA:MARK:MKR1:RIGHT
set_analyzer_marker1tomin	CA:MARK:MKR1:MIN, SA:MARK:MKR1:MIN
set_analyzer_marker1topeak	CA:MARK:MKR1:PEAK, SA:MARK:MKR1:PEAK
set_analyzer_marker2enable	CA:MARK:MKR2:ENAB, SA:MARK:MKR2:ENAB
set_analyzer_marker2position	CA:MARK:MKR2:POS, SA:MARK:MKR2:POS
set_analyzer_marker2setsref	CA:MARK:MKR2:SCF, SA:MARK:MKR2:SCF
set_analyzer_marker2setsleft	CA:MARK:MKR2:LEFT, SA:MARK:MKR2:LEFT
set_analyzer_marker2setsref	CA:MARK:MKR2:SREF, SA:MARK:MKR2:SREF
set_analyzer_marker2setsright	CA:MARK:MKR2:RIGHT, SA:MARK:MKR2:RIGHT
set_analyzer_marker2tomin	CA:MARK:MKR2:MIN, SA:MARK:MKR2:MIN
set_analyzer_marker2topeak	CA:MARK:MKR2:PEAK, SA:MARK:MKR2:PEAK
set_analyzer_mode	SA:MODE
set_analyzer_peakenable	CA:TRAC:PEAK:ENAB, SA:TRAC:PEAK:ENAB
set_analyzer_preamp_enable	RF:ANAL:REC:AMP
set_analyzer_rbw	CA:COUP:RBW:VAL, SA:COUP:RBW:VAL
set_analyzer_rbwauto	CA:COUP:RBW:AUTO, SA:COUP:RBW:AUTO
set_analyzer_source	CA:SOUR, SA:SOUR
set_analyzer_span	CA:HOR:FREQ:SPAN, SA:HOR:FREQ:SPAN
set_analyzer_startfreq	CA:HOR:FREQ:START, SA:HOR:FREQ:START
set_analyzer_startrel	CA:HOR:FREQ:START:REL
set_analyzer_stopfreq	CA:HOR:FREQ:STOP, SA:HOR:FREQ:STOP
set_analyzer_stoprel	CA:HOR:FREQ:STOP:REL
set_analyzer_sweep	CA:COUP:SWE:VAL, SA:COUP:SWE:VAL
set_analyzer_sweepauto	CA:COUP:SWE:AUTO, SA:COUP:SWE:AUTO
set_analyzer_sweepcont	INIT:CONT:CA, INIT:CONT:SA
set_analyzer_sweepsingle	INIT:IMM:CA, INIT:IMM:SA
set_analyzer_tos	CA:VERT:LEV, SA:VERT:LEV
set_analyzer_vbwauto	CA:COUP:VBW:AUTO, SA:COUP:VBW:AUTO
set_analyzer_vdiv	CA:VERT:VDIV, SA:VERT:VDIV

AutoTest Command	AutoTest II Command
set_analyzer_videobw	CA:COUP:VBW:VAL, SA:COUP:VBW:VAL
set_antibpower_average	CONF:RF:ANAL:AIP:AVER
set_antibpower_llen	LIM:RF:AIP:LOW:ENAB
set_antibpower_llimit	LIM:RF:AIP:LOW:VAL
set_antibpower_ulen	LIM:RF:AIP:UPP:ENAB
set_antibpower_ulimit	LIM:RF:AIP:UPP:VAL
set_audio_distortion_average	CONF:AF:ANAL:DIST:AVER
set_audio_distortion_ulen	LIM:AF:DIST:UPP:ENAB
set_audio_distortion_ulimit	LIM:AF:DIST:UPP:VAL
set_audio_filter	AF:ANAL:MFIL
set_audio_freq_average	CONF:AF:ANAL:FREQ:AVER
set_audio_hn_average	CONF:AF:ANAL:HN:AVER
set_audio_hn_llen	LIM:AF:HN:LOW:ENAB
set_audio_hn_llimit	LIM:AF:HN:LOW:VAL
set_audio_hn_lockref	CONF:AF:ANAL:HN:REF
set_audio_hn_ulen	LIM:AF:HN:UPP:ENAB
set_audio_hn_ulimit	LIM:AF:HN:UPP:VAL
set_audio_impedance	CONF:AF:ANAL:SOUR:LOAD
set_audio_level_average	CONF:AF:ANAL:LEV:AVER
set_audio_level_llen	LIM:AF:LEV:LOW:ENAB
set_audio_level_llimit	LIM:AF:LEV:LOW:VAL
set_audio_level_ulen	LIM:AF:LEV:UPP:ENAB
set_audio_level_ulimit	LIM:AF:LEV:UPP:VAL
set_audio_port	CONF:PORT:FGEN
set_audio_psoph_filter	CONF:AF:MFIL:TYP
set_audio_sinad_average	CONF:AF:ANAL:SIN:AVER
set_audio_sinad_llen	LIM:AF:SIN:LOW:ENAB
set_audio_sinad_llimit	LIM:AF:SIN:LOW:VAL
set_audio_snr_average	CONF:AF:ANAL:SNR:AVER
set_audio_snr_llen	LIM:AF:SNR:LOW:ENAB
set_audio_snr_llimit	LIM:AF:SNR:LOW:VAL
set_audio_snr_mode	CONF:AF:ANAL:SNR
set_audio_snr_ulen	LIM:AF:SNR:UPP:ENAB
set_audio_snr_ulimit	LIM:AF:SNR:UPP:VAL
set_audio_source	CONF:AF:ANAL:SOUR
set_fgen_ch0_enable	AF:GEN:SOUR1:ENAB
set_fgen_ch0_freq	AF:GEN:SOUR1:SINE:FREQ, AF:GEN:SOUR1:SQU:FREQ
set_fgen_ch0_level	AF:GEN:SOUR1:LEV
set_fgen_ch0_type	AF:GEN:SOUR1:SHAP
set_fgen_ch1_enable	AF:GEN:SOUR2:ENAB
set_fgen_ch1_freq	AF:GEN:SOUR2:SINE:FREQ, AF:GEN:SOUR1:SQU:FREQ
set_fgen_ch1_level	AF:GEN:SOUR2:LEV

AutoTest Command	AutoTest II Command
set_fgen_ch1_type	AF:GEN:SOUR2:SHAP
set_fgen_ch2_enable	AF:GEN:SOUR3:ENAB
set_fgen_ch2_freq	AF:GEN:SOUR3:SINE:FREQ, AF:GEN:SOUR1:SQU:FREQ
set_fgen_ch2_level	AF:GEN:SOUR3:LEV
set_fgen_ch2_type	AF:GEN:SOUR3:SHAP
set_ptt_out	CONF:RF:GEN:PTTOUT
set_rferror_freqoff_average	CONF:RF:ANAL:FOFF:AVER
set_rferror_freqoff_ulen	LIM:RF:FOFF:UPP:ENAB
set_rferror_freqoff_ulimit	LIM:RF:FOFF:UPP:VAL
set_rferror_resolution	CONF:RF:ANAL:FRES
set_rfgen_enable	RF:GEN:ENAB
set_rfgen_freq	RF:GEN:FREQ
set_rfgen_level	RF:GEN:LEV
set_rfgen_offseten	CONF:OFFS:GEN:ENAB
set_rfgen_port	RF:GEN:PORT
set_rfrec_freq	RF:ANAL:FREQ
set_rfrec_offseten	CONF:OFFS:ANAL:ENAB
set_rfrec_port	RF:ANAL:PORT
set_scope_marker1enable	SCOP:MKR1:ENAB
set_scope_marker2enable	SCOP:MKR2:ENAB
set_scope_sweepate	SCOP:HDIV
set_scope_traceacoupling	SCOP:ATR:COUP
set_scope_tracealevel	SCOP:ATR:VDIV
set_scope_traceaposition	SCOP:ATR:VPOS
set_scope_traceasource	SCOP:ATR:SOUR
set_scope_tracebcoupling	SCOP:BTR:COUP
set_scope_traceblevel	SCOP:BTR:VDIV
set_scope_tracebposition	SCOP:BTR:VPOS
set_scope_tracebsource	SCOP:BTR:SOUR
set_scope_trigedge	SCOP:TRIG:EDGE
set_scope_trigfilter	SCOP:TRIG:FILT
set_scope_triglevel	SCOP:TRIG:LEV
set_scope_trigmode	SCOP:TRIG:MODE
set_scope_trigsource	SCOP:TRIG:SOUR
set_trbbpower_average	CONF:RF:ANAL:TRBP:AVER
set_trbbpower_llen	LIM:RF:TRBP:LOW:ENAB
set_trbbpower_llimit	LIM:RF:TRBP:LOW:VAL
set_trbbpower_ulen	LIM:RF:TRBP:UPP:ENAB
set_trbbpower_ulimit	LIM:RF:TRBP:UPP:VAL
set_trbbpower_zero	RF:POWER:DETECTOR:ZERO
set_tribpower_average	CONF:RF:ANAL:TRIP:AVER
set_tribpower_llen	LIM:RF:TRIP:LOW:ENAB

AutoTest Command	AutoTest II Command
set_tribpower_llimit	LIM:RF:TRIP:LOW:VAL
set_tribpower_ulen	LIM:RF:TRIP:UPP:ENAB
set_tribpower_ulimit	LIM:RF:TRIP:UPP:VAL
sw_pause	PAUSE
swflowcontrol_usb_to_serial	USBTOSER:SWFL
termination_usb_to_serial	USBTOSER:TERM
test_amfmdemod_amlevel	test_demod_am
test_amfmdemod_fmdev	test_demod_fm 0
test_amfmdemod_fmrms	test_demod_fm 1
test_amfmmod_distortion	test_demod_dist
test_amfmmod_hn	test_demod_hn
test_amfmmod_sinad	test_demod_sinad
test_amfmmod_snr	test_demod_snr
test_antib_power	test_aib_power
test_audio_distortion	test_audio_dist
test_audio_hn	test_audio_hn
test_audio_level	test_audio_level
test_audio_sinad	test_audio_sinad
test_audio_snr	test_audio_snr
test_bb_power	test_trbb_power
test_freq_error	test_freq_error
test_trib_power	test_trib_power
timeout_usb_to_serial	USBTOSER:TIMEOUT
write_usb_to_serial	USBTOSER:WRITE

THIS PAGE INTENTIONALLY LEFT BLANK.

Chapter 6 - Radio Test Instruments

6.1 INTRODUCTION

This chapter explains the use of the 3900 Spectrum Analyzer, Channel Analyzer, and Oscilloscope Instruments. This chapter is intended for users familiar with the general principles and use of these instruments.

6.2 MARKERS

3900 Instruments include marker functions which allow users to obtain measurements at specified points on a signal. Implementation of marker functions varies according to the instrument. This section uses the Channel Analyzer Marker functions as examples.

6.2.1 Enabling Markers

Markers are enabled using the following methods:

- Setting Marker 1/Marker 2 Soft Key to ENABLE;
- Selecting Marker from drop-down menu, then setting Marker Enable toggle button to ON (this applies to Spectrum Analyzer and Channel Analyzer);
- Setting marker toggle button(s) to Enabled state.

6.2.2 Positioning Markers

Marker position is adjusted by the following methods:

- By focusing on the Marker Position field and entering a value in the data field;
- By focusing on the Marker Position field and using the Rotary Control Knob to move the selected marker to a new reference point.
- (Mouse option) By focusing on the Marker Position field and using a mouse to click and drag the selected marker to the desired location on the display field.
- The Mkr 1/Mkr 2 Soft Keys access additional soft keys that also adjust marker position on the display field.

NOTE	Instrument Markers are designed to maintain focus on the last selected marker. Selecting a non-marker function or parameter does not cause the Test Set to lose marker focus. When using a mouse clicking on the graph field repositions the last selected marker to that position.
-------------	---

6.2.3 Marker Readings

Marker readings are displayed on the upper left hand corner of the trace field. Marker readings include the position of each marker and the reading at the marker position. The Delta reading is displayed when Marker 1 and Marker 2 are ENABLED.

NOTE

The Power (Pwr) Between Markers reading is available when the Analyzer Occupied Bandwidth and Power Between Markers Option (390XOPT064) is installed in the Test Set. Marker 1 and Marker 2 must both be enabled to display the Power Between Markers measurement.

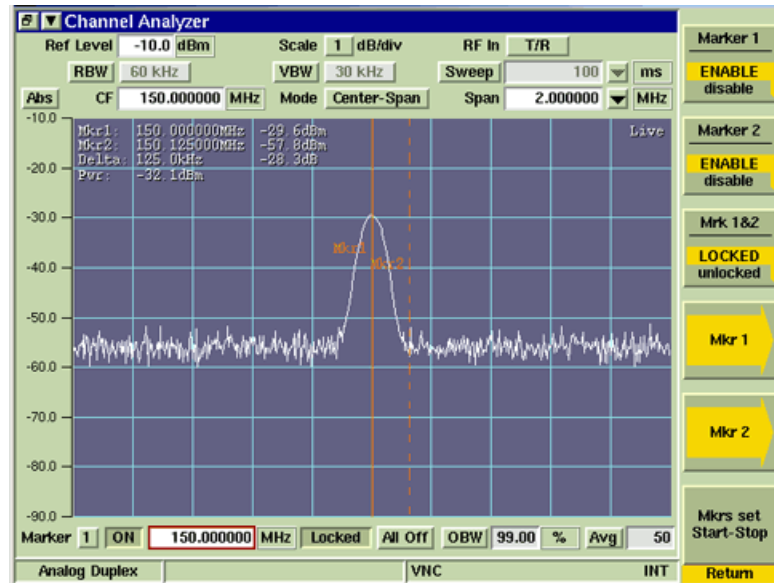

Fig. 6-1 Marker Readings

6.2.4 Marker Field Definitions

This section describes the marker fields available throughout 3900 instruments. These fields are not present on all instrument and measurement tiles.

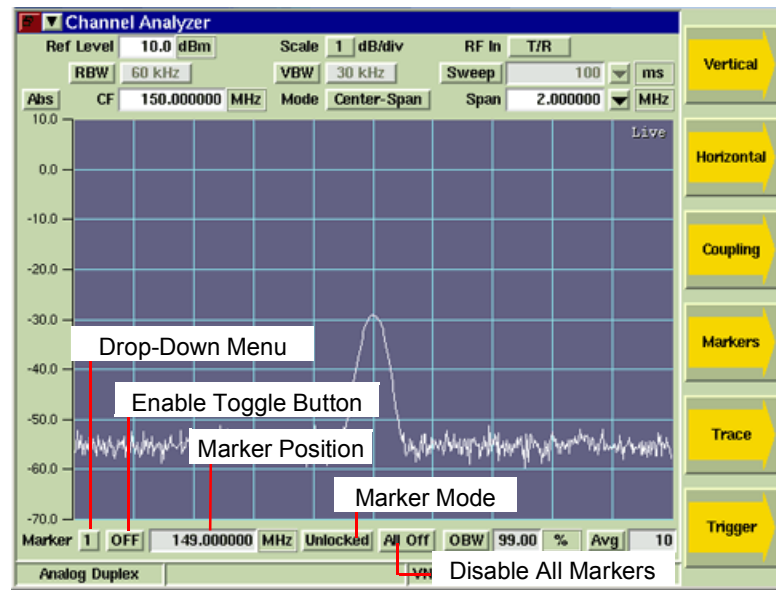

Fig. 6-2 Channel Analyzer Marker Field/Toggle Buttons

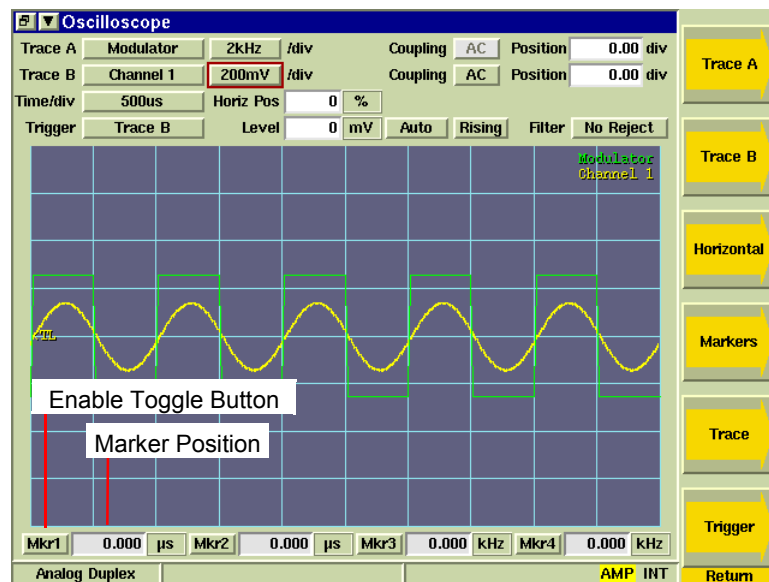

Fig. 6-3 Scope Marker Field/Toggle Buttons

6.2.4.A Marker Drop-Down Menu

The Marker drop-down menu selects Marker focus.

6.2.4.B Marker Enable Toggle Button

The Marker Enable toggle button enables/disables the selected marker.

6.2.4.C Marker Position

The Marker Position field defines where a marker is positioned on the plot field.

6.2.4.C.1 Channel Analyzer/Spectrum Analyzer

The Marker 1 through Marker 6 position fields designate the marker position along the span of the signal. When operating in Zero-Span Mode, marker position is specified in time, not frequency. Marker 1 through Marker 6 indicators appear as vertical lines along the plot field's horizontal axis.

The Marker 7 and Marker 8 position fields designate the marker position along the vertical scale. Marker 7 and Marker 8 indicators appear as horizontal lines along the plot field's vertical axis.

6.2.4.C.2 Oscilloscope

The Marker 1 and Marker 2 position fields designate the marker position along the horizontal scale which is measured in Time/div. Marker 1 and Marker 2 indicators appear as vertical lines along the plot field's horizontal axis.

The Marker 3 and Marker 4 position fields designate the marker position along the vertical scale which is measured in n/div (where n is the scale unit of measurement which is defined by the type of measurement being performed). Marker 3 and Marker 4 indicators appear as horizontal lines along the plot field's vertical axis.

6.2.4.D Marker Mode Toggle Button

The Marker Mode Soft Key and toggle button define the locked state of Marker 1 and Marker 2. This function only applies to Marker 1 and Marker 2. When Marker 3 through 8 are selected in the Marker drop-down menu, the Marker Mode Toggle Button appears disabled.

Refer to Mkr 1&2 Mode (Soft Key for information on using this function).

6.2.4.E All Off Toggle Button

Pressing the All Off Toggle Button disables all enabled markers.

6.2.5 Marker Soft Key Definitions

This section describes the marker soft keys available throughout 3900 instruments. These soft keys are not present on all instrument and measurement tiles.

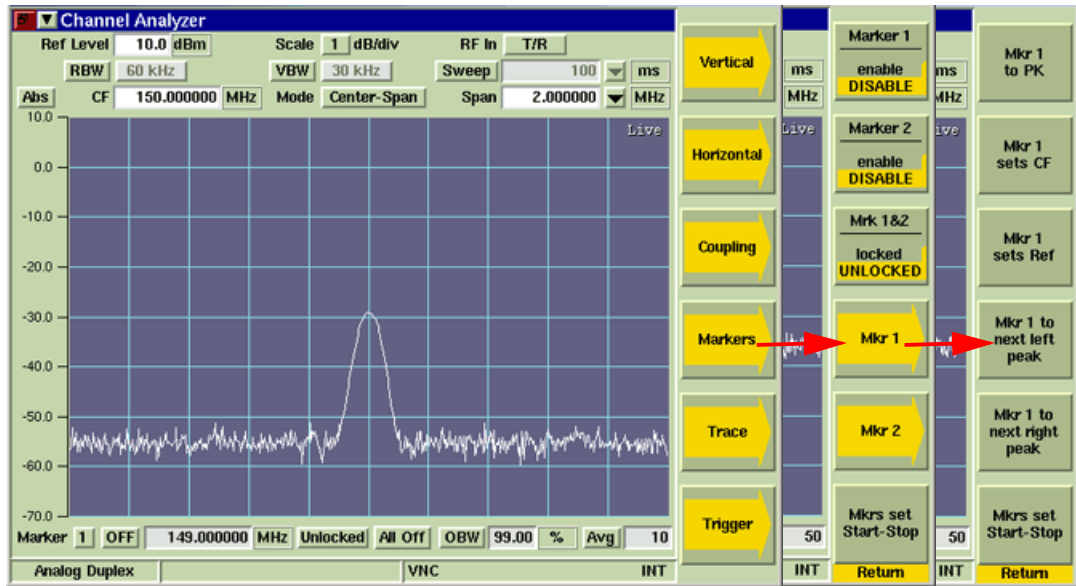

Fig. 6-4 Markers Soft Key Sub-menus

6.2.5.A Marker 1/Marker 2 Soft Key

The Marker 1 and Marker 2 Soft Keys enable or disable the corresponding marker. Markers can also be enabled using the Marker Enable toggle button.

6.2.5.B Mkr 1&2 Mode Soft Key

The Mkr 1&2 Mode Soft Key defines the Lock/Unlocked state of Marker 1 and Marker 2. The LOCKED state links Marker 1 and Marker 2 together at the current frequency spacing. When the markers are LOCKED, moving Marker 1 or Marker 2 moves the other marker while maintaining the current frequency spacing. UNLOCKED removes the link between markers.

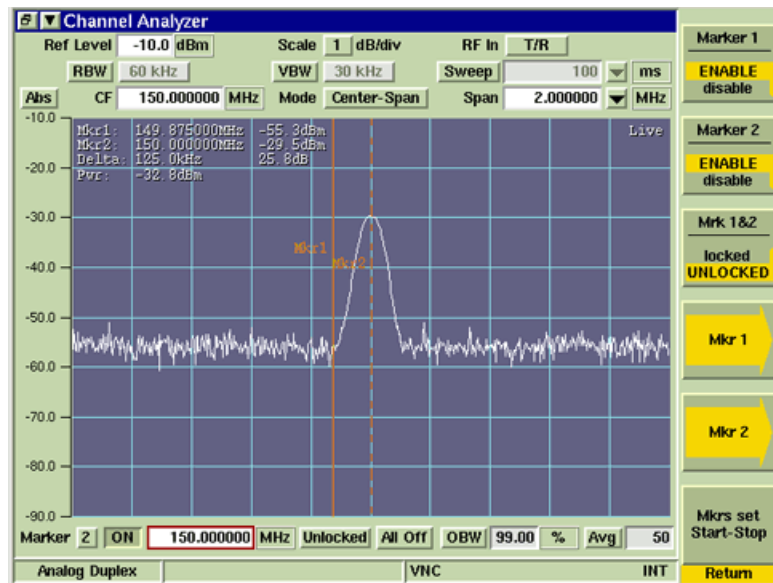

Fig. 6-5 Markers 1 and 2 - LOCKED State

Fig. 6-5 shows Marker 1 set to 149.875 MHz and Marker 2 set to 150.00 MHz, with markers in LOCKED state. Fig. 6-6 shows Marker 1 changed to 150.00 MHz, which repositions Marker 2 to 150.125 MHz, maintaining the frequency spacing established before enabling the LOCKED state.

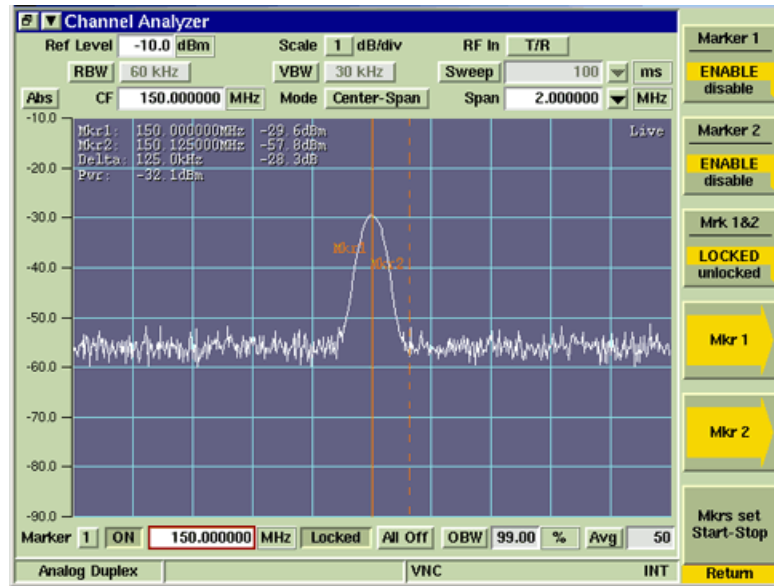

Fig. 6-6 LOCKED Markers - Repositioned While in LOCKED State

6.2.5.C Mkr 1/Mkr 2 Soft Key

The Mkr1 and Mkr 2 Soft Keys open a soft key sub-menu that provides automated marker functions. A Marker must be enabled to use these marker functions. This soft key is accessed by pressing the Markers Soft Key.

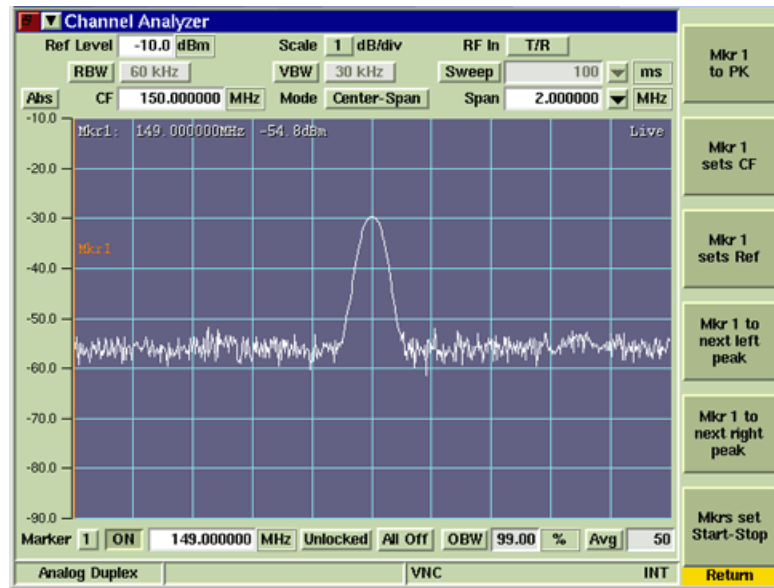

Fig. 6-7 Mkr 1/Mkr 2 Soft Key Sub-menu

6.2.5.D Mkr 1 (or 2) to PK Soft Key

The Mkr to Peak Soft Key moves Marker 1 or 2 to the position of the peak value shown on the current trace. This soft key is accessed by pressing the Mkr 1/Mkr 2 Soft Key.

6.2.5.E Mkr 1 (or 2) Sets CF Soft Key

Sets the Center frequency to the reading at Marker 1 or Marker 2. This soft key is accessed by pressing the Mkr 1/Mkr 2 Soft Key.

6.2.5.F Mkr 1 (or 2) Sets Ref Soft Key

The Mkr to Ref Soft Key sets the Ref Level to the value of Marker 1 or 2 level measurement, with no headroom or offset value. This soft key is accessed by pressing the Mkr 1/Mkr 2 Soft Key.

6.2.5.G Mkr 1 (or 2) to Next Left Peak

The Marker to Next Left Peak Soft Key moves Marker 1 or 2 to the next peak to the left of the present Marker 1 or 2 position. This soft key is accessed by pressing the Mkr 1/Mkr 2 Soft Key.

6.2.5.H Mkr 1 (or 2) to Next Right Peak

The Marker to Next Right Peak Soft Key moves Marker 1 or 2 to the next peak to the right of the present Marker 1 or 2 position. This soft key is accessed by pressing the Mkr 1/Mkr 2 Soft Key.

6.2.5.I Mkrs Set Start-Stop Soft Key

The Mkr to Start/Stop Soft Key sets the left edge of the trace to the frequency value of Marker 1 and the right edge of the trace to the frequency value of Marker 2. This soft key is accessed by pressing the Mkr 1/Mkr 2 Soft Key.

6.2.5.J Toggle Marker Soft Key

The Toggle Marker Soft Key changes focus between Marker 1 and Marker 2 when both markers are enabled. The Toggle Marker Soft Key also controls the marker readings displayed at the top of the minimized tile. Each press of this Soft Key changes the source of the measurements through Mkr1, Mkr2 and Delta readouts.

The Toggle Marker Soft Key is only available on some tiles when the tile is minimized, as shown for the Channel Analyzer in Fig. 6-8.

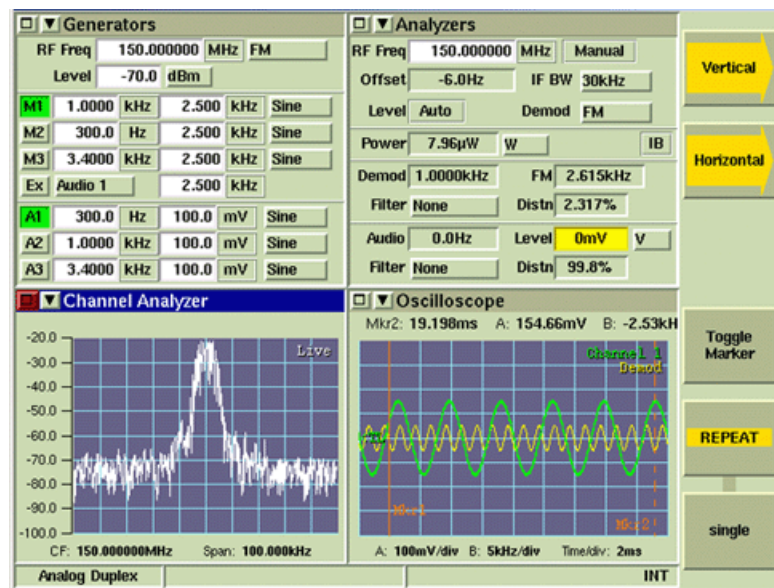

Fig. 6-8 Toggle Marker Soft Key

6.2.6 Marker Configuration Tiles

Markers for the Channel and Spectrum Analyzer can also be configured on the Analyzer Markers Configuration Tile.

6.2.6.A Channel Analyzer Markers Configuration Tile

The Channel Analyzer Markers Configuration Tile is accessed from the Test Mode Configuration Menu.

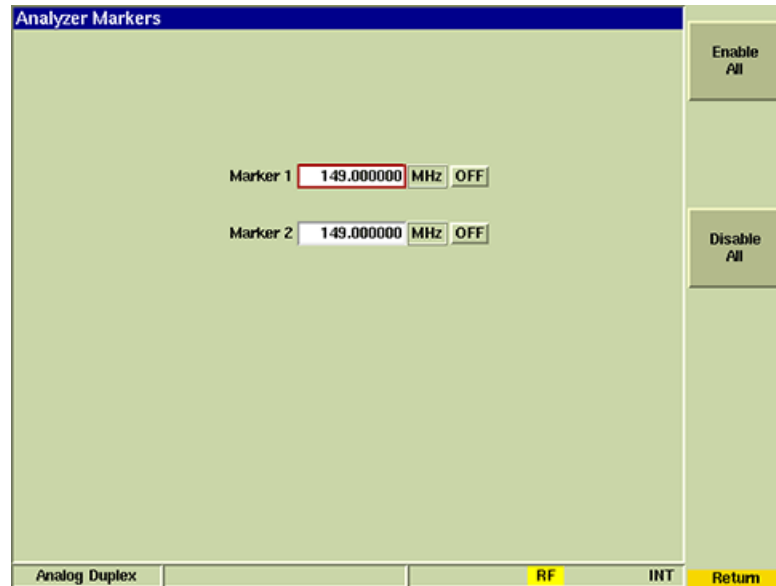

Fig. 6-9 Audio Analyzer Markers Configuration Tile

6.2.6.B Spectrum Analyzer Markers Configuration Tile

The Spectrum Analyzer Markers Configuration Tile is accessed from the Configuration Menu when the Spectrum Analyzer is selected.

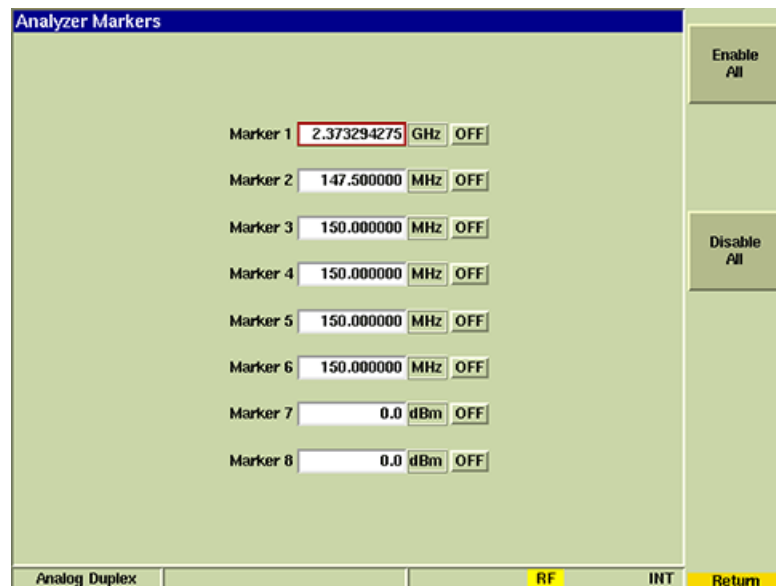

Fig. 6-10 Spectrum Analyzer Markers Configuration Tile

6.3 CHANNEL ANALYZER

The Channel Analyzer is an asynchronous, swept analyzer that displays the spectrum of the RF signal received by the Test Set over a 5 MHz bandwidth centered on the Rx frequency. The source of the signal for the Channel Analyzer is the receiver chain of the Test Set.

Refer to 3900 Platform Specifications for the Channel Analyzer's operating parameters.

NOTE

The Channel Analyzer shares the RF path from the connector to the receiver. Therefore the Channel Analyzer is dependent on the receiver for connector selection, global attenuation and Center Frequency (within +/- 2.5 MHz of the received Center Frequency).

6.3.1 Basic Settings

The frequency span of the display must include the RF Frequency being examined. The Reference Level of the display must be set so that the RF signal level falls within the display area. The Channel Analyzer Tile can be used in minimized or maximized view.

6.3.2 Field Definitions

6.3.2.A Reference Level

The Reference Level sets the top value on the display graph. Power levels can be measured at any point on the trace in conjunction with the Scaling dB/div setting. The Reference Level can be set to any value within the specified range. The Reference Level is set by:

- Using the Expand and Contract Soft Keys to make step changes.
- Selecting the data field and using the Rotary Control Knob to adjust the level.
- Selecting the data field and using the Data Entry Input Keys to enter specific level.

6.3.2.B Scaling dB/div

The Scaling drop-down menu selects from a range of 1, 2, 5, or 10. The scaling value (dB/div) can then be increased or decreased using the Expand or Contract Soft Keys.

6.3.2.C RF In (Source)

The RF In toggle button selects the RF Input connector (signal source).

6.3.2.D RBW (Resolution Bandwidth) Toggle Button

The RBW toggle button selects the RBW bandwidth mode of operation. When Auto is selected, RBW is system defined to a value appropriate to the signal type being displayed. When Manual is selected, a drop-down menu becomes accessible which allows user to select from three defined bandwidth settings. This toggle button is linked to the Res BW (Resolution Bandwidth) Soft Key which can also be used to define the RBW setting which functions in the same manner.

6.3.2.E VBW (Video Bandwidth) Toggle Button

The VBW toggle button selects the VBW bandwidth mode of operation. When Auto is selected, VBW is system defined to a value appropriate to the signal type being displayed. When Manual is selected, a drop-down menu becomes accessible which allows user to select from a list of defined bandwidth settings. This toggle button is linked to the Vid BW (Video Bandwidth) Soft Key which can also be used to define the VBW setting which functions in the same manner.

6.3.2.F Sweep Toggle Button

The Sweep toggle button selects the Sweep Time mode of operation. When Auto is selected, the Sweep Time is system defined to a value appropriate to the signal type being displayed. When Manual is selected, a drop-down menu becomes accessible which allows user to select from a list of defined Sweep Time settings. This toggle button is linked to the Sweep Time Soft Key which can also be used to define the Sweep Time setting which functions in the same manner.

6.3.2.G (Span) Mode

The Span Mode drop-down menu selects the span mode used to define the displayed signal trace. Available options are Start-Stop Mode, Center-Span Mode and Zero-Span Mode.

6.3.2.G.1 Start - Stop Span Mode

Start-Stop Span Mode uses the sweep Start and Stop frequencies to define the span. The example below shows an RF signal displayed from 149.0 MHz to 151.0 MHz as defined by the Start and Stop values.

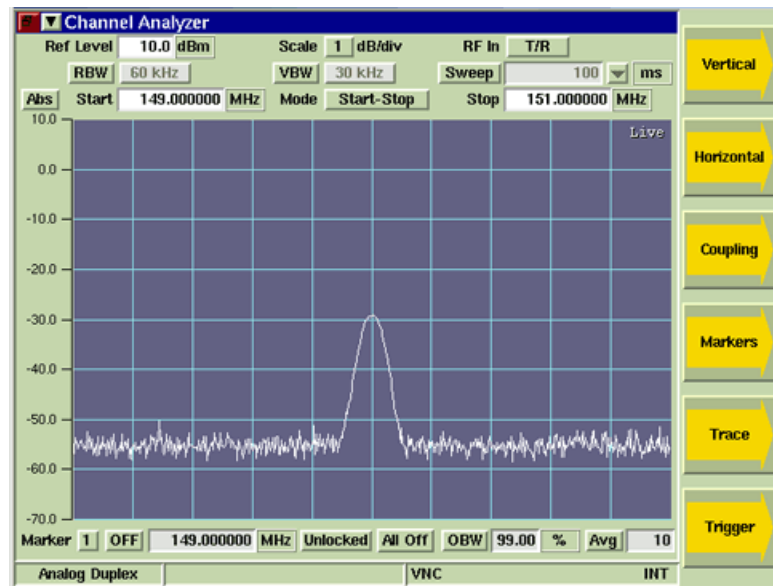

Fig. 6-11 Channel Analyzer Start and Stop Frequency Setting

6.3.2.G.2 Center - Span Mode

Center-Span Mode uses the sweep Center Frequency value and span setting to define the frequency span. The maximum span of the display is 5 MHz, which is equal to the channel width of the Test Set receiver.

The following example shows the Center Frequency set to 150.0 MHz which is the frequency of the RF Channel to which the Test Set Receiver is tuned. The Span is set to 2.0 MHz.

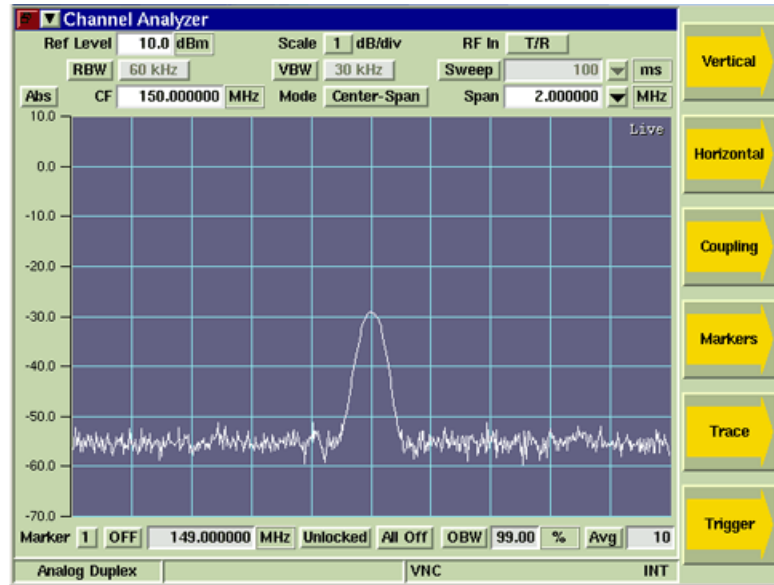

Fig. 6-12 Channel Analyzer Center Frequency and Span Setting

6.3.2.G.3 Zero - Span Mode

In Zero Span Mode the Channel Analyzer does not perform a frequency sweep: it detects the power level at the set frequency. The trace shows detected power against time. When operating in Zero-Span Mode, marker position is specified in time.

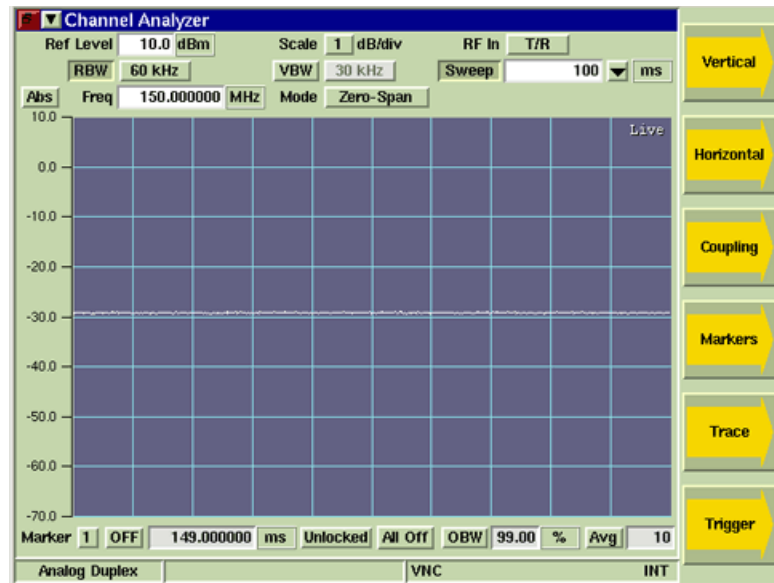

Fig. 6-13 Channel Analyzer Zero Span Example

6.3.2.H ABS (Absolute) Frequency

When Abs is selected the value displayed in the CF field is the received frequency.

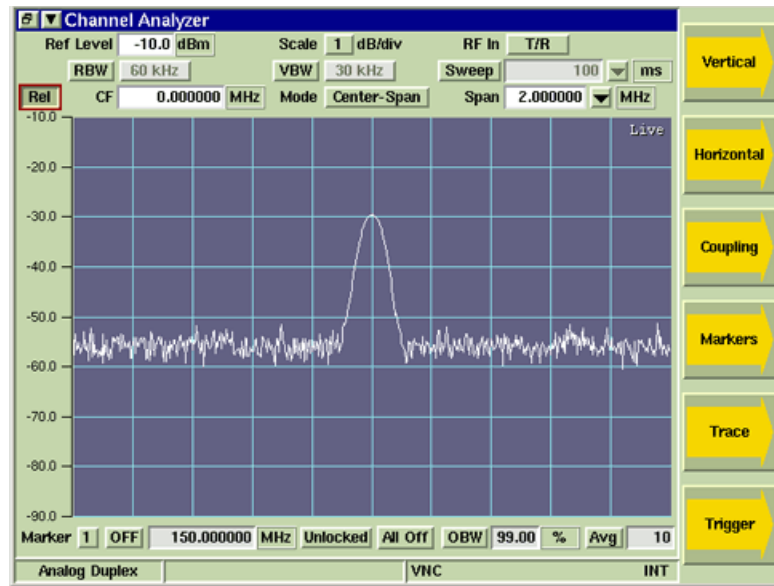

Fig. 6-14 Channel Analyzer Absolute Setting

6.3.2.I Rel (Relative) Frequency

When Rel is selected the value displayed in the CF field is relative to the received frequency.

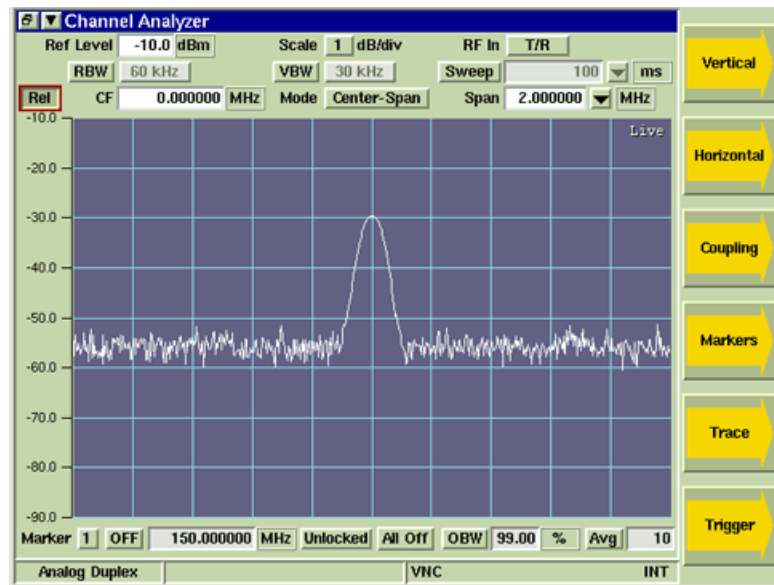

Fig. 6-15 Channel Analyzer Relative Setting

6.3.2.J Span

When Center-Span Mode is selected, signal span can be adjusted by selecting a defined value from the Span drop-down menu or by selecting the Span data entry field and entering an arbitrary value. Span can also be adjusted using the Expand/Contract Soft Keys.

6.3.2.K Averages

The Averages toggle button Enables/Disables Average measurements. The Averages field defines the number of signal traces used to calculate average measurements. Refer to Trace Soft Key for additional information on Average measurements.

6.3.3 Soft Key Definitions

6.3.3.A Vertical Soft Key

The Vertical Soft Key accesses scaling and positioning controls that adjust the trace's position on the display. The up/down arrow keys move the signal trace up or down on the display, simultaneously adjusting the Reference Level. The Expand/Contract Soft Keys adjust the height of the signal trace, which can also be changed using the Scaling dB/div drop-down menu.

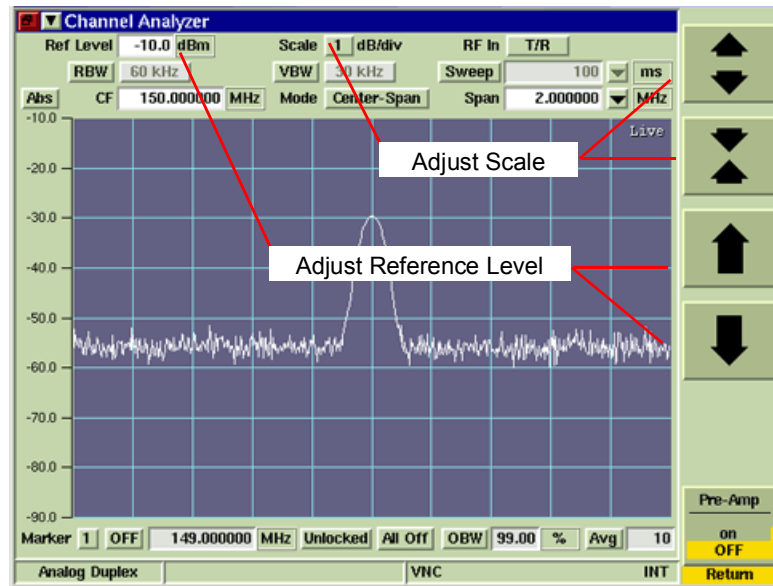

Fig. 6-16 Channel Analyzer - Ref Level and Scale Settings

6.3.3.B Horizontal Soft Key

The Horizontal Soft Key accesses a group of soft keys that adjust the horizontal scaling and position of the signal on the graph field.

The left/right arrow keys move the trace right or left on the display field, which simultaneously adjusts the Center Frequency or Start/Stop Frequency, depending on selected span mode. The Expand/Contract Soft Keys adjust the span of the trace, which can also be adjusted by changing the Span setting.

6.3.3.C (Frequency) Mode Soft Key

The Mode Soft Key defines the Channel Analyzer Center Frequency in relation to the RF Analyzer Frequency. When LOCK Mode is selected, changing the Channel Analyzer Center Frequency changes the Receive Frequency on the RF Analyzer Tile to the same value. When UNLOCKED is selected, changing the Channel Analyzer Center Frequency updates the trace to a position value relative to the RF Analyzer Receive Frequency.

NOTE

When changing the Center Frequency, the value must be within ± 2.5 MHz of the RF Analyzer Frequency.

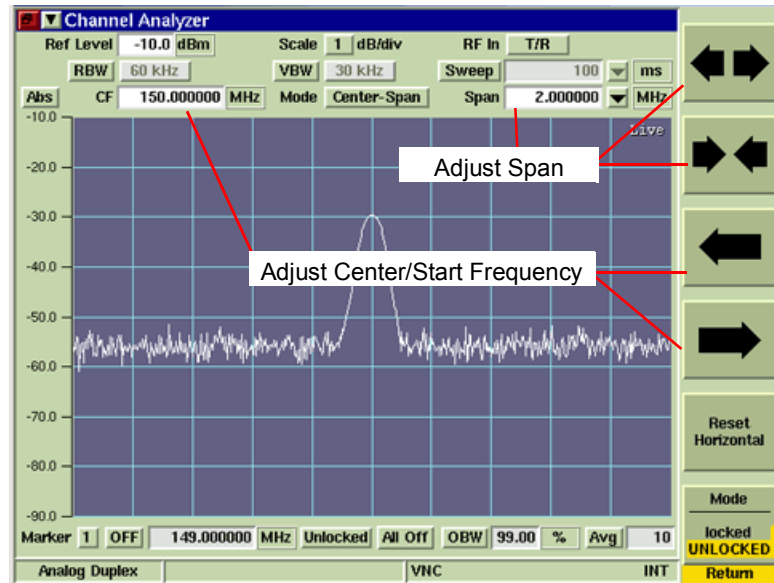

Fig. 6-17 Channel Analyzer Start and Stop Frequency Setting

6.3.3.D Coupling Soft Key

The Capture Soft Key accesses a Soft Key sub-menu that allows user to define Resolution and Video Bandwidths as well as Sweep Time.

The Coupling Soft Key Menu consists of RBW, VBW and Sweep Time settings which are all interdependent and govern the usefulness of a trace. These Soft Keys are controlled by inter-related action so that changing the value of one changes one or both of the others to optimize the display and prevent an invalid setting. RBW, VBW and Sweep Time can be set to AUTO or MANUAL operation.

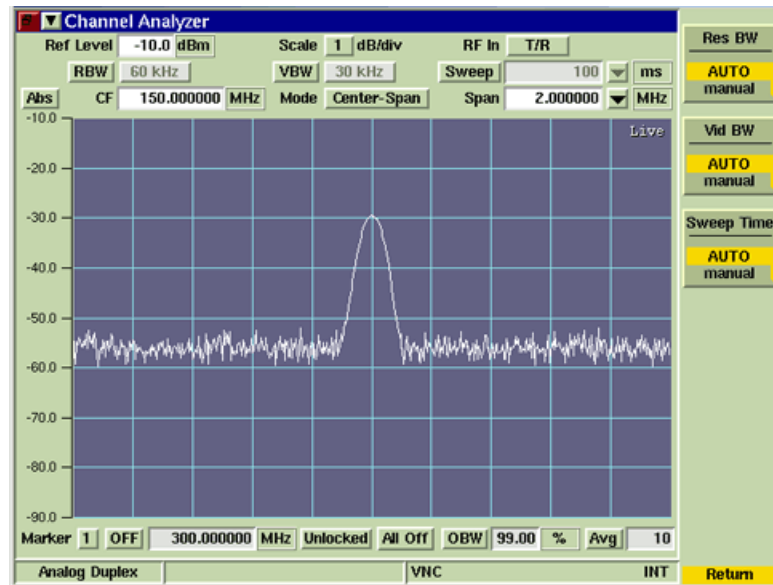

Fig. 6-18 Channel Analyzer Coupling Soft Key Menu

NOTE

For many applications, setting all three parameters to AUTO provides a useful representation of the signal to be examined. However, parameters can be set to specific requirements, allowing the Test Set to select the optimum setting for the other two parameters according to internal setup tables.

6.3.3.E Res BW (Resolution Bandwidth) Soft Key

Resolution Bandwidth sets the bandwidth of the IF filter. Resolution is the ability of the Channel Analyzer to discriminate between signals closely separated in frequency. For example, if two signals are analyzed, the Channel Analyzer is only able to discriminate between them if the resolution bandwidth selected is narrower than the separation between the signals. Filter selection becomes more critical if the tones are at different levels. Narrow resolution bandwidth also results in lower noise on the trace.

NOTE

When performing power measurements, the Resolution Bandwidth must be set to a value equal or greater than the bandwidth of the signal being measured.

6.3.3.F Vid BW (Video Bandwidth) Soft Key

To view signals close to the noise level, a low pass filter (called the video filter) is introduced after the detector. The Video Bandwidth is the high frequency cutoff point of the filter. The video filter reduces high frequency noise on the detected signal and enables low level signals to be identified that would otherwise be buried in the noise.

6.3.3.G Sweep Time Soft Key

The Sweep Time setting defines how quickly trace data is acquired and updated to the display. This setting must be fast enough to provide quick measurement results, but slow enough to allow the power values at each point to be measured. When set to AUTO, the Test Set optimizes the Sweep Time. When set to MANUAL, a defined Sweep Time setting can be selected from the drop-down menu or an arbitrary value can be entered by selecting the Sweep Time data field.

When Sweep Time is set to 1 second or longer, a white progress bar is shown across the bottom of the graph field while the sweep is accumulating as shown below. The yellow progress bar at the upper right corner of the graph field is the average progress indicator.

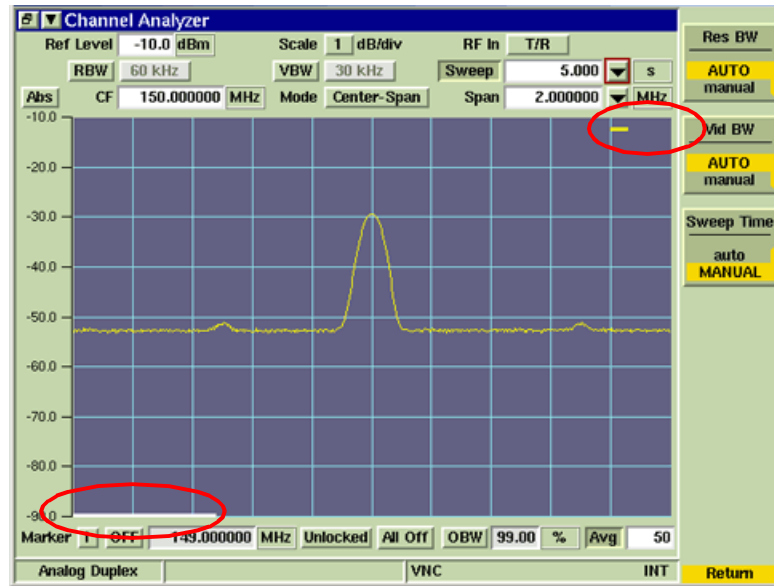

Fig. 6-19 Channel Analyzer Sweep and Averaging Progress Bars

6.3.3.H Marker Fields and Soft Keys

Marker functionality is described in the Markers section located at the beginning of this chapter.

6.3.3.I Trace Soft Key

The Trace Soft Key accesses trace display control functions to allow users to obtain average and peak measurements and to capture traces being displayed on the plot field.

6.3.3.I.1 Trace Color

Trace types being displayed on the graph are listed in the upper right corner of the graph field. The traces are color-coded to identify trace types.

- Live traces are White.
- Peak hold traces are Red.
- Averaged traces are Yellow.
- Captured traces are Green.

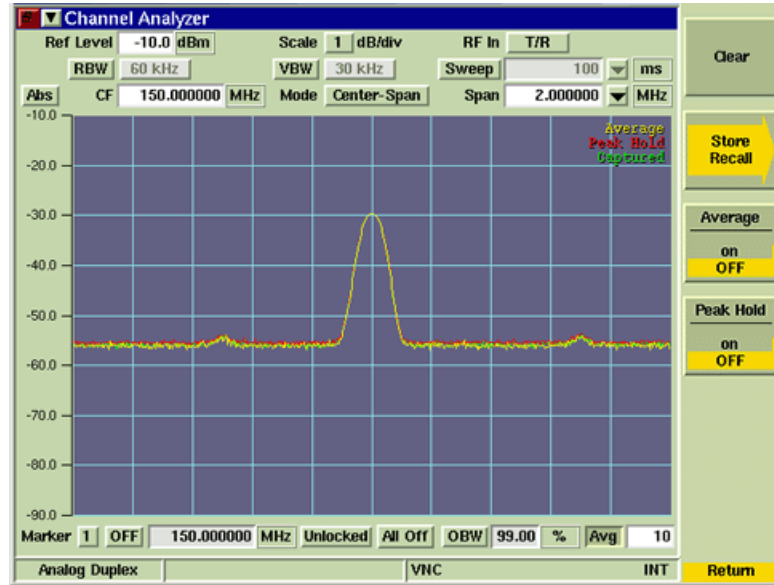

Fig. 6-20 Channel Analyzer Trace Soft Key

6.3.3.J Capture Soft Key

When the Capture Soft Key is pressed a trace is held on the display. Traces are captured in the following priority:

- Peak Trace (Priority 1)
- Average Trace (Priority 2)
- Live Trace (Priority 3)

For example, if Average and Peak Traces are both enabled, the Peak Trace is captured. If Live and Peak Traces are being displayed, the Peak trace is captured. Refer to the following chart for notes about how to capture specific trace types.

Capture Trace	Setup to Store Trace
Peak Trace	Enable Peak Trace.
Average Trace	Enable Average Trace. Peak Trace must be OFF.
Live Trace	Average and Peak Trace must be OFF.

6.3.3.K Clear Soft Key

The Clear Soft Key is enabled when a trace is in “Captured” state. Pressing the Clear Soft Key clears the current captured trace and resumes normal sweep operation.

6.3.3.L Store Trace Soft Key

The Store Trace Soft Keys allows a user to store a signal trace. If more than one type of trace is enabled the traces are stored in the following priority:

- Captured Trace (Priority 1)
- Peak Trace (Priority 2)
- Average Trace (Priority 3)
- Live Trace (Priority 4)

For example, if Average and Peak Traces are both enabled and a trace has been captured, the Captured Trace is stored. If Average and Peak Traces are being displayed, the Peak trace is stored. Refer to the following chart for notes about how to store specific trace types.

Store Trace	Setup to Store Trace
Captured Trace	Capture Trace must be engaged.
Peak Trace	Enable Peak Trace. Clear any Captured Trace.
Average Trace	Enable Average Trace. Peak Trace must be OFF. Clear any Captured Trace.
Live Trace	Average and Peak Trace must be OFF. Clear any Captured Trace.

6.3.3.M Recall Trace Soft Key

The Recall Trace Soft Key opens a dialog box that allows the user to load stored trace data.

6.3.3.N Peak Hold Soft Key

When Peak Hold ON is selected, the maximum value at each frequency point is displayed to produce the RED Max Hold trace. This trace is cleared by selecting Peak Hold OFF. Peak Hold must be reset (toggled ON/OFF) when Average readings are Enabled/Disabled. The white Live trace is also displayed and can be averaged depending on the current setting. This soft key is accessed by pressing the Trace Soft Key.

6.3.3.O Average Soft Key

When the Average Soft Key is ON, the trace is calculated by averaging the number of measurements defined in the Averages field. The calculated value is a rolling average or a one-shot average as defined on the Trigger Tile using the Repeat Soft Key and Single Soft Key. A yellow progress indicator is displayed in the upper right corner of the graph field while the average reading is accumulating. This soft key is accessed by pressing the Trace Soft Key.

6.3.3.P Trigger Soft Key

The Trigger Soft Key accesses features to control how the trace is triggered. The Channel Analyzer trace is configured to free run repetitively.

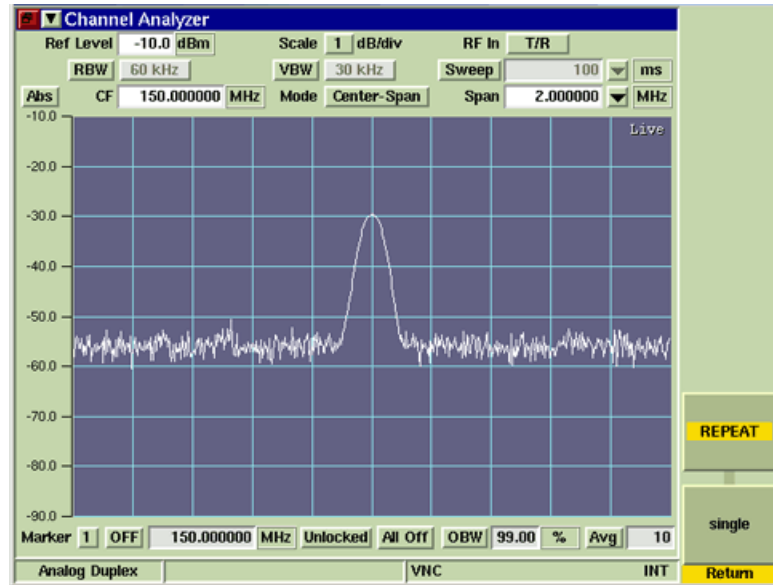

Fig. 6-21 Channel Analyzer with Trigger Soft Keys

6.3.3.Q Repeat Soft Key

When Repeat Soft Key is selected the trace runs repeatedly. The Repeat and Single Soft Keys define the trace display averaging calculations.

When Average Soft Key is set to ON, pressing Repeat clears the last averaged trace and initiates a new averaged trace. This soft key is accessed by pressing the Trigger Soft Key.

6.3.3.R Single Soft Key

The Single Soft Key places the trace in Single Sweep Mode. If Average Soft Key on the Trace Display Tile is set to ON, and Single is selected, a single trace is initiated when the trigger conditions are met. This soft key is accessed by pressing the Trigger Soft Key.

6.4 SPECTRUM ANALYZER

The Spectrum Analyzer is an asynchronous, swept analyzer that displays the RF spectrum of the received RF Signal. The Spectrum Analyzer frequency span must include the RF Frequency being examined and the Reference Level must be set so the RF signal level falls within the display area. The Spectrum Analyzer is accessed from TEST Mode by pressing the Test Key. Refer to 3900 Platform Specifications for the Spectrum Analyzer's operating parameters.

6.4.1 Basic Settings

When using the Spectrum Analyzer, the frequency span must include the RF Frequency being examined and the Reference Level must be set so the RF signal level falls within the display area.

6.4.2 Accessing the Spectrum Analyzer

The Spectrum Analyzer is accessed from the TEST Floating menu of each 3900 Test System.

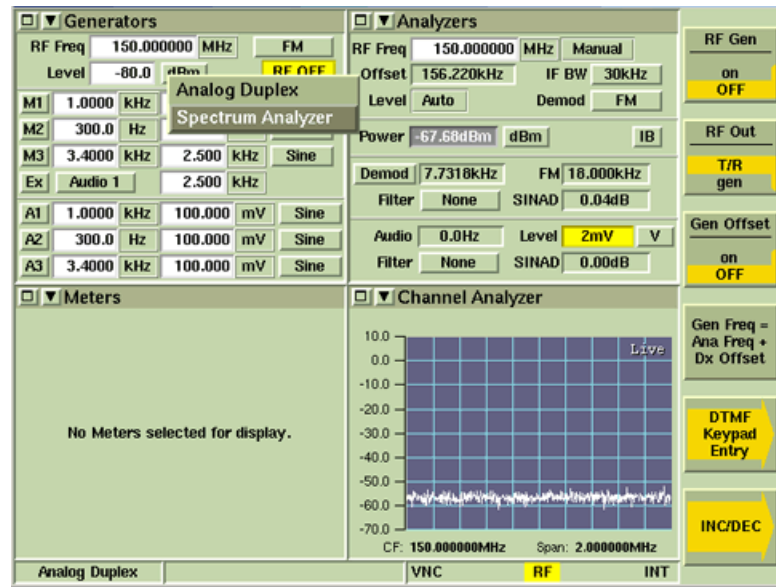

Fig. 6-22 Accessing Spectrum Analyzer - TEST Floating Menu

6.4.3 Spectrum Analyzer Tile Layout

The Spectrum Analyzer is always displayed as a full tile. The majority of the parameter fields are available on the main display tile; others are available by pressing the soft keys.

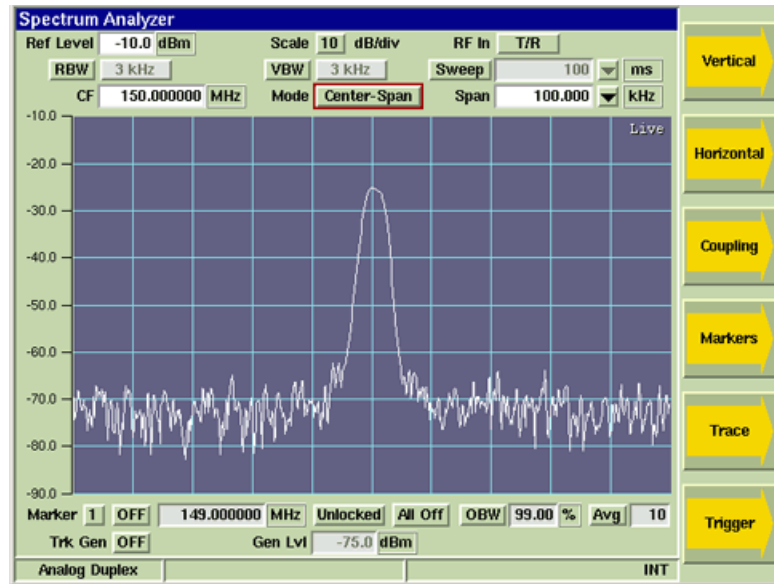

Fig. 6-23 Spectrum Analyzer Tile

6.4.4 Field Definitions

6.4.4.A Reference Level

The Reference Level sets the top value on the display graph. Power levels can be measured at any point on the trace in conjunction with the Scaling dB/div setting. The Reference Level can be set to any value within the specified range. The Reference Level is set by:

- Using the Expand and Contract Soft Keys to make step changes.
- Selecting the data field and using the Rotary Control Knob to adjust the level.
- Selecting the data field and using the Data Entry Input Keys to enter specific level.

6.4.4.B Scaling dB/div

The Scaling drop-down menu selects from a range of 1, 2, 5, or 10. The scaling value (dB/div) can then be increased or decreased using the Expand or Contract Soft Keys.

6.4.4.C RF In (Source)

The RF In toggle button selects the RF Input connector (signal source).

6.4.4.D RBW (Resolution Bandwidth) Toggle Button

The RBW toggle button selects the RBW bandwidth mode of operation. When Auto is selected, RBW is system defined to a value appropriate to the signal type being displayed. When Manual is selected, a drop-down menu becomes accessible which allows user to select from three defined bandwidth settings. This toggle button is linked to the Res BW (Resolution Bandwidth) Soft Key which can also be used to define the RBW setting which functions in the same manner.

6.4.4.E VBW (Video Bandwidth) Toggle Button

The VBW toggle button selects the VBW bandwidth mode of operation. When Auto is selected, VBW is system defined to a value appropriate to the signal type being displayed. When Manual is selected, a drop-down menu becomes accessible which allows user to select from a list of defined bandwidth settings. This toggle button is linked to the Vid BW (Video Bandwidth) Soft Key which can also be used to define the VBW setting which functions in the same manner.

6.4.4.F Sweep Toggle Button

The Sweep toggle button selects the Sweep Time mode of operation. When Auto is selected, the Sweep Time is system defined to a value appropriate to the signal type being displayed. When Manual is selected, a drop-down menu becomes accessible which allows user to select from a list of defined Sweep Time settings. This toggle button is linked to the Sweep Time Soft Key which can also be used to define the Sweep Time setting which functions in the same manner.

6.4.4.G (Span) Mode

The Span Mode drop-down menu selects the span mode used to define the displayed signal trace. Available options are Start-Stop Mode, Center-Span Mode and Zero-Span Mode.

6.4.4.G.1 Start - Stop Span Mode

Start-Stop Span Mode uses the sweep Start and Stop frequencies to define the span. The example below shows an RF signal displayed from 149.95 MHz to 150.05 MHz as defined by the Start and Stop values.

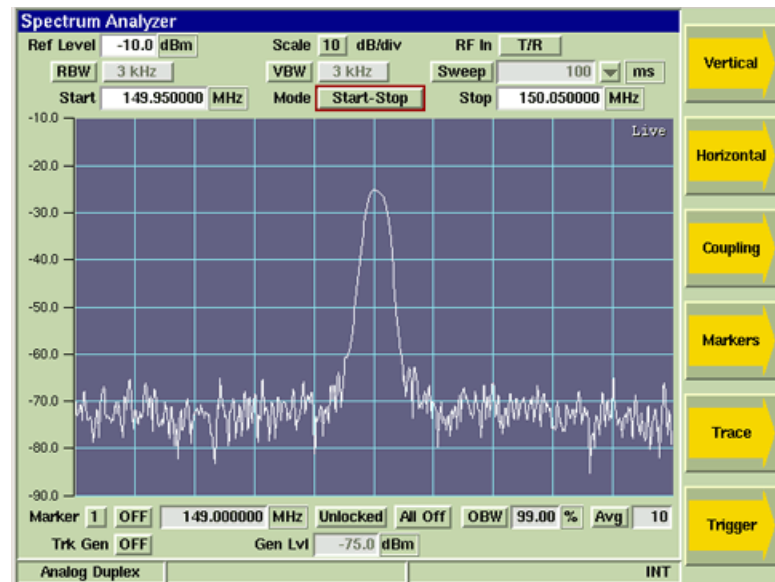

Fig. 6-24 Spectrum Analyzer Start and Stop Frequency Setting

6.4.4.G.2 Center - Span Mode

Center-Span Mode uses the sweep Center frequency value and span setting to define the frequency span. The maximum span of the display is 5 MHz, which is equal to the channel width of the Test Set receiver.

The following example shows the Center Frequency set to 150.0 MHz which is the frequency of the RF Channel to which the Test Set Receiver is tuned. The Span is set to 2.0 MHz.

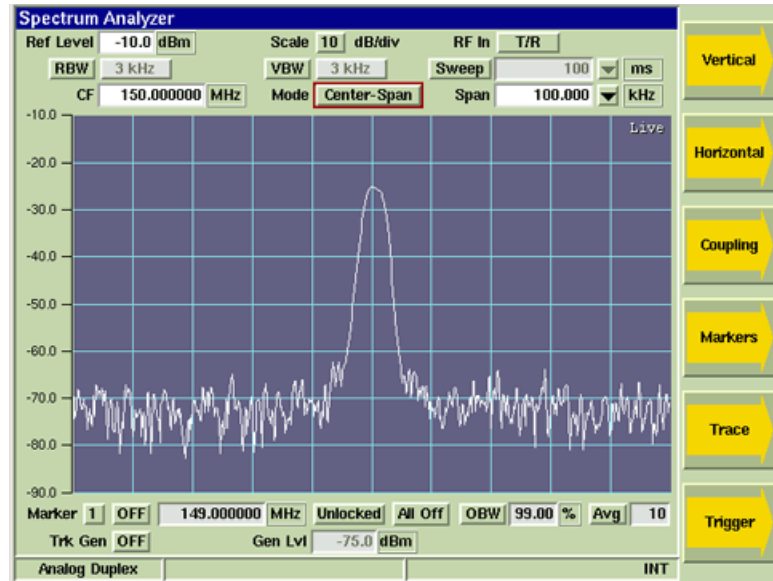

Fig. 6-25 Spectrum Analyzer Center Frequency and Span Setting

6.4.4.G.3 Zero Span Mode

In Zero Span Mode the Spectrum Analyzer does not perform a frequency sweep: it detects the power level at the set frequency. The trace shows detected power against time.

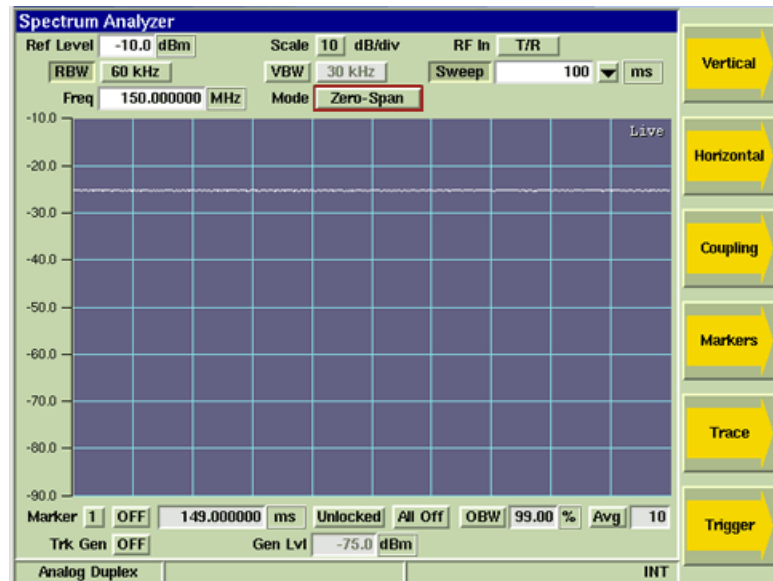

Fig. 6-26 Spectrum Analyzer Zero Span Example

Fig. 6-26 shows an Analog Duplex signal burst at a frequency of 150.000000 MHz, against a time base sweep of 100 ms.

6.4.4.H Span

When Center-Span Mode is selected, signal span can be adjusted by selecting a defined value from the Span drop-down menu or by selecting the Span data entry field and entering an arbitrary value. Span can also be adjusted using the Expand/Contract Soft Keys.

6.4.4.I Averages

The Averages toggle button Enables/Disables Average measurements. The Averages field defines the number of signal traces used to calculate average measurements. Refer to Trace Soft Key for additional information on Average measurements.

6.4.5 Soft Key Definitions

6.4.5.A Vertical Soft Key

The Vertical Soft Key accesses scaling and positioning controls that adjust the trace's position on the display. The up/down arrow keys move the signal trace up or down on the display, simultaneously adjusting the Reference Level. The Expand/Contract Soft Keys adjust the height of the signal trace, which can also be changed using the Scaling dB/div drop-down menu.

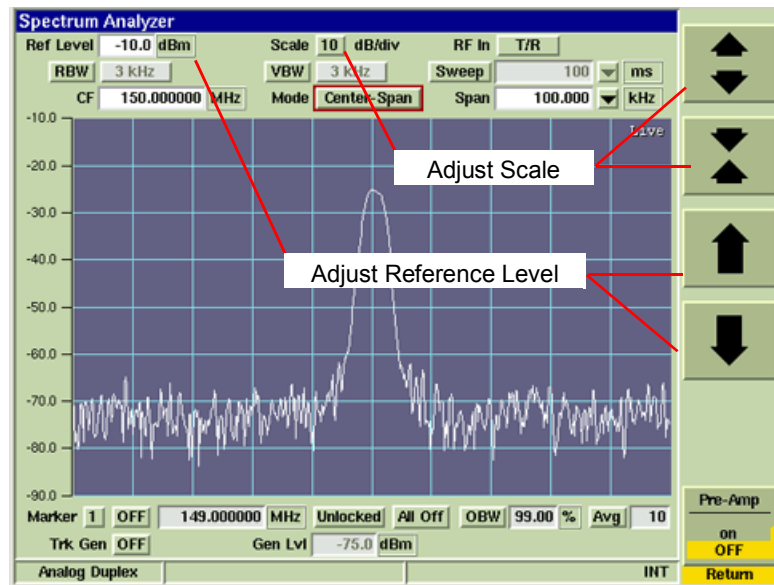

Fig. 6-27 Spectrum Analyzer Vertical Settings Tile

6.4.5.B Horizontal Soft Key

The Horizontal Soft Key accesses a group of soft keys that adjust the horizontal scaling and position of the signal on the graph field. The left/right arrow keys move the trace right or left on the display field, which simultaneously adjusts the Center and/or Start Frequency, depending on the span mode selected. The Expand/Contract Soft Keys adjust the span of the trace, which can also be adjusted by changing the Span setting.

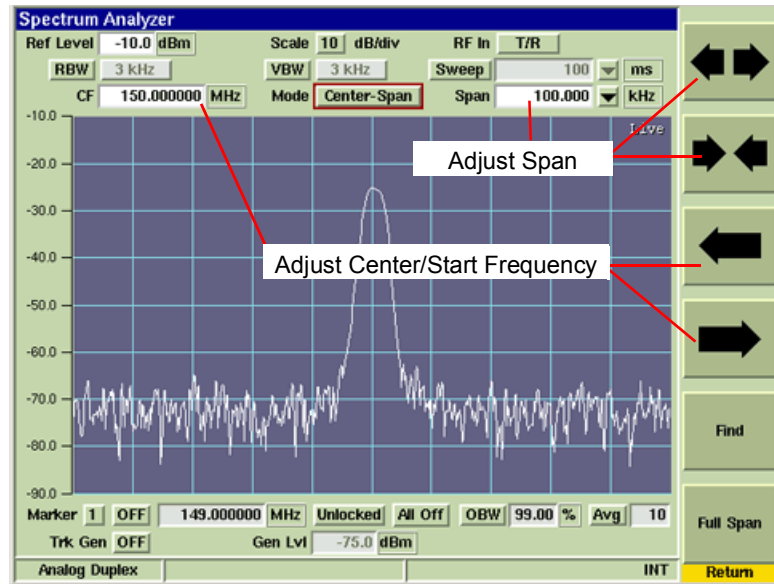

Fig. 6-28 Spectrum Analyzer Horizontal Settings Tile

6.4.5.C Find Soft Key

This soft key is accessed by pressing the Horizontal Soft Key. Pressing the Find Soft Key sweeps the Test Set's available frequency range and sets Center Frequency to highest signal peak along frequency range.

6.4.5.D Full Span Soft Key

This soft key is accessed by pressing the Horizontal Soft Key. Pressing Full Span sets the Start - Stop signal span to the Test Set's frequency range.

6.4.5.E Coupling Soft Key

The Capture Soft Key accesses a Soft Key sub-menu that allows user to define Resolution and Video Bandwidths as well as Sweep Time. The Coupling Soft Key Menu consists of RBW, VBW and Sweep Time settings which are all interdependent and govern the usefulness of a trace. These Soft Keys are controlled by inter-related action so that changing the value of one changes one or both of the others to optimize the display and prevent an invalid setting. RBW, VBW and Sweep Time can be set to AUTO or MANUAL operation.

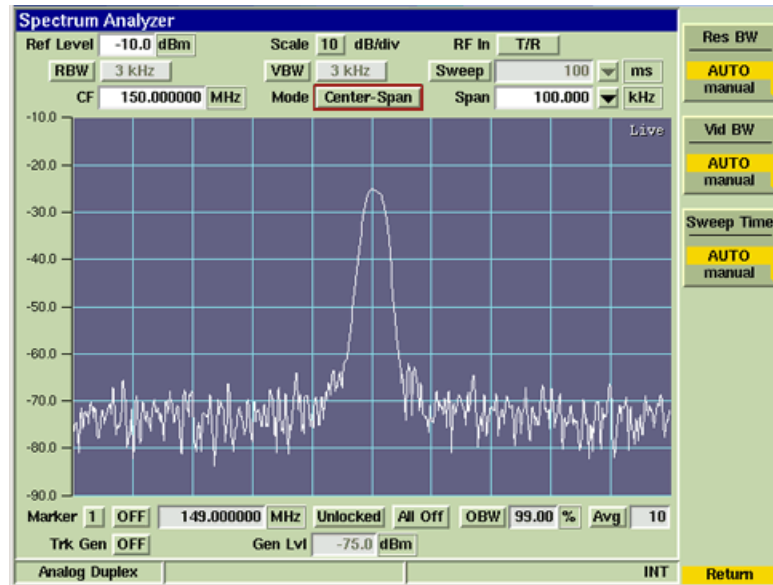

Fig. 6-29 Spectrum Analyzer Coupling Soft Key Menu

6.4.5.F Res BW (Resolution Bandwidth) Soft Key

Resolution Bandwidth sets the bandwidth of the IF filter. Resolution is the ability of the Spectrum Analyzer to discriminate between signals closely separated in frequency. For example, if two signals are analyzed, the Spectrum Analyzer is only able to discriminate between them if the resolution bandwidth selected is narrower than the separation between the signals. Filter selection becomes more critical if the tones are at different levels. Narrow resolution bandwidth also results in lower noise on the trace.

NOTE

When performing power measurements, the Resolution Bandwidth must be set to a value equal or greater than the bandwidth of the signal being measured.

6.4.5.G Vid BW (Video Bandwidth) Soft Key

To view signals close to the noise level, a low pass filter (called the video filter) is introduced after the detector. The Video Bandwidth is the high frequency cutoff point of the filter. The video filter reduces high frequency noise on the detected signal and enables low level signals to be identified that would otherwise be buried in the noise.

6.4.5.H Sweep Time Soft Key

The Sweep Time setting defines how quickly trace data is acquired and updated to the display. This setting must be fast enough to provide quick measurement results, but slow enough to allow the power values at each point to be measured. When set to AUTO, the Test Set optimizes the Sweep Time. When set to MANUAL, a defined Sweep Time setting can be selected from the drop-down menu or an arbitrary value can be entered by selecting the Sweep Time data field.

When Sweep Time is set to 1 second or longer, a white progress bar is shown across the bottom of the graph field while the sweep is accumulating as shown below. The yellow progress bar at the upper right corner of the graph field is the average progress indicator.

6.4.5.I Marker Fields and Soft Keys

The Spectrum Analyzer supports six vertical markers (Markers 1 to 6) and two horizontal markers (Markers 7 and 8) as shown in Fig. 6-30. Markers 1 to 6 can be positioned at any point along the graph's Span setting. Marker 7 and 8 can be positioned at any point along the graph's vertical scale.

Marker functionality is described in the section titled Markers located at the beginning of this chapter.

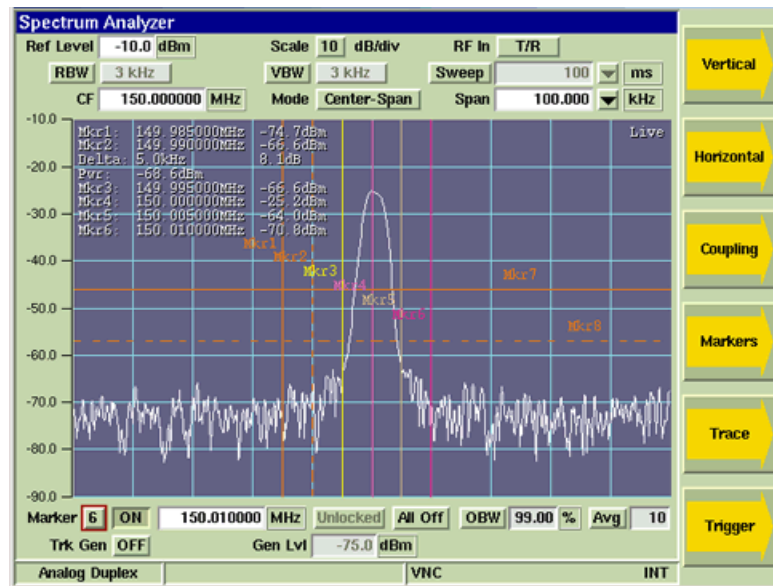

Fig. 6-30 Spectrum Analyzer - All Markers Enabled

6.4.5.J Trace Soft Key

The Trace Soft Key accesses trace display control functions to allow users to obtain average and peak measurements and to capture traces being displayed on the plot field.

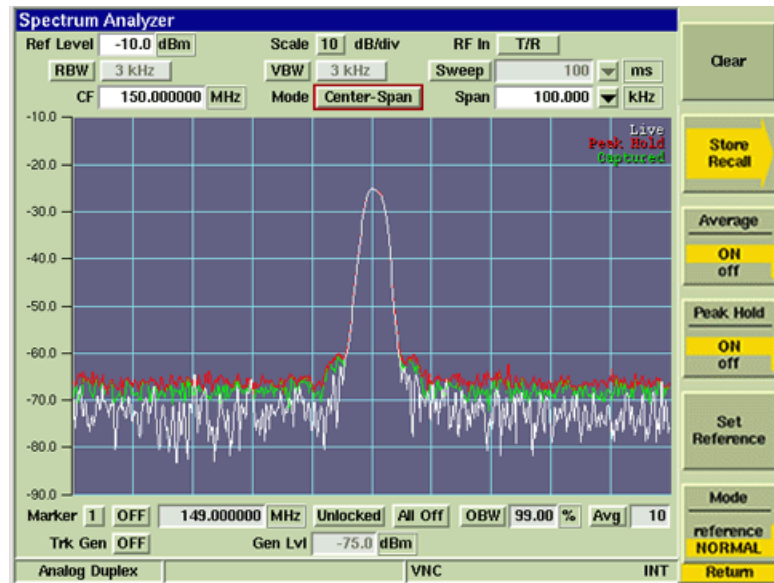

Fig. 6-31 Spectrum Analyzer with Live, Peak and Captured Traces

6.4.5.J.1 Trace Color

Trace types being displayed on the graph are listed in the upper right corner of the graph field. The traces are color-coded to identify trace types.

- Live traces are White.
- Peak hold traces are Red.
- Averaged traces are Yellow.
- Captured traces are Green.

6.4.5.K Capture Soft Key

When the Capture Soft Key is pressed a trace is held on the display. Traces are captured in the following priority:

- Peak Trace (Priority 1)
- Average Trace (Priority 2)
- Live Trace (Priority 3)

For example, if Average and Peak Traces are both enabled, the Peak Trace is captured. If Live and Peak Traces are being displayed, the Peak trace is captured. Refer to the following chart for notes about how to capture specific trace types.

Capture Trace	Setup to Store Trace
Peak Trace	Enable Peak Trace.
Average Trace	Enable Average Trace. Peak Trace must be OFF.
Live Trace	Average and Peak Trace must be OFF.

6.4.5.L Clear Soft Key

The Clear Soft Key is enabled when a trace is in “Captured” state. Pressing the Clear Soft Key clears the current captured trace and resumes normal sweep operation.

6.4.5.M Store Trace Soft Key

The Store Trace Soft Keys allows a user to store a signal trace. If more than one type of trace is enabled the traces are stored in the following priority:

- Captured Trace (Priority 1)
- Peak Trace (Priority 2)
- Average Trace (Priority 3)
- Live Trace (Priority 4)

For example, if Average and Peak Traces are both enabled and a trace has been captured, the Captured Trace is stored. If Average and Peak Traces are being displayed, the Peak trace is stored. Refer to the following chart for notes about how to store specific trace types.

Trace Type	Setup to Store Trace
Captured Trace	Capture Trace must be engaged.
Peak Trace	Enable Peak Trace. Clear any Captured Trace.
Average Trace	Enable Average Trace. Peak Trace must be OFF. Clear any Captured Trace.
Live Trace	Average and Peak Trace must be OFF. Clear any Captured Trace.

6.4.5.N Recall Trace Soft Key

The Recall Trace Soft Key opens a dialog box that allows the user to load stored signal trace.

6.4.5.O Peak Hold Soft Key

When Peak Hold ON is selected, the maximum value at each frequency point is displayed to produce the RED Max Hold trace. This trace is cleared by selecting Peak Hold OFF. Peak Hold must be reset (toggled ON/OFF) when Average readings are Enabled/Disabled. The white Live trace is also displayed and can be averaged depending on the current setting. This soft key is accessed by pressing the Trace Soft Key.

6.4.5.P Set Reference Soft Key

When the Set Reference Soft Key is pressed, the Test Set stores current trace data which is used to establish a reference trace when Reference Mode is selected. This soft key is accessed by pressing the Trace Soft Key.

6.4.5.Q Trace Mode Soft Key

Selects Normal or Reference trace mode of operation for the analyzer trace. When Reference Mode is selected, the Test Set uses the last stored trace reference (refer to Set Reference Soft Key) to establish a frequency response of the characteristics of the cabling and test setup. This response is used as a reference for the active trace being displayed on the Spectrum Analyzer Tile. This soft key is accessed by pressing the Trace Soft Key.

6.4.5.R Trigger Soft Key

The Trigger Soft Key accesses features to control how the trace is triggered.

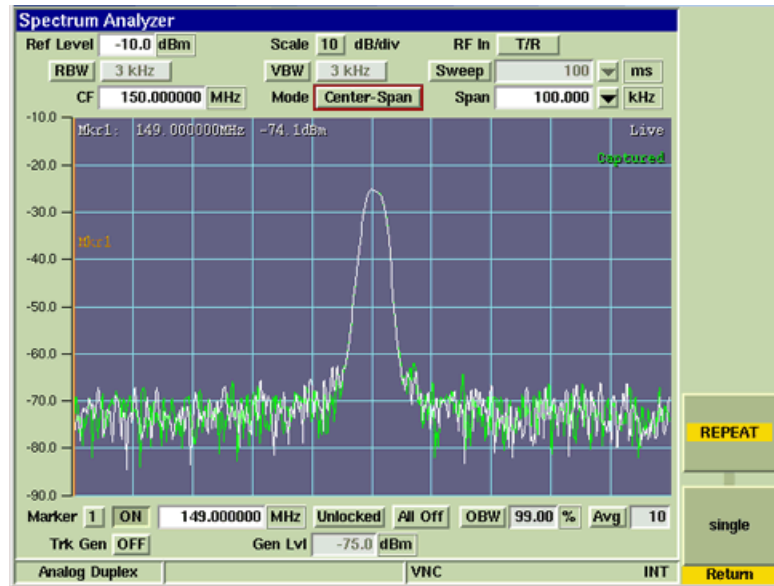

Fig. 6-32 Spectrum Analyzer with Live Trace

6.4.5.S Repeat Soft Key

When Repeat Soft Key is selected the trace runs repeatedly. The Repeat and Single Soft Keys define the trace display averaging calculations.

When Average Soft Key is set to ON, pressing Repeat clears the last averaged trace and initiates a new averaged trace. This soft key is accessed by pressing the Trigger Soft Key.

6.4.5.T Single Soft Key

The Single Soft Key places the trace in Single Sweep Mode. If Average Soft Key on the Trace Display Tile is set to ON, and Single is selected, a single trace is initiated when the trigger conditions are met. This soft key is accessed by pressing the Trigger Soft Key.

6.5 OSCILLOSCOPE

The Oscilloscope provides two channels for examining AF waveforms. Input signals can be routed from the CH1 and CH2 Connectors, or from the internal audio sources, to either Trace A or Trace B source options. Source and Coupling can be set differently for each trace and Auto or Normal modes of triggering can be selected and configured to respond to a rising or falling input voltage.

Refer to 3900 Platform Specifications for the Oscilloscope's operating parameters.

6.5.1 Basic Settings

Scope Source and Coupling parameters can be set differently for each trace. The second row of data at the top of the Tile shows the Trace Trigger settings. These settings are accessed by pressing the Trigger Soft Key. Auto or Normal modes of triggering can be selected and configured to respond to a rising or falling input voltage.

6.5.2 Accessing the Oscilloscope

The Oscilloscope is accessed from the drop-down menus on System Test Measurements Tiles.

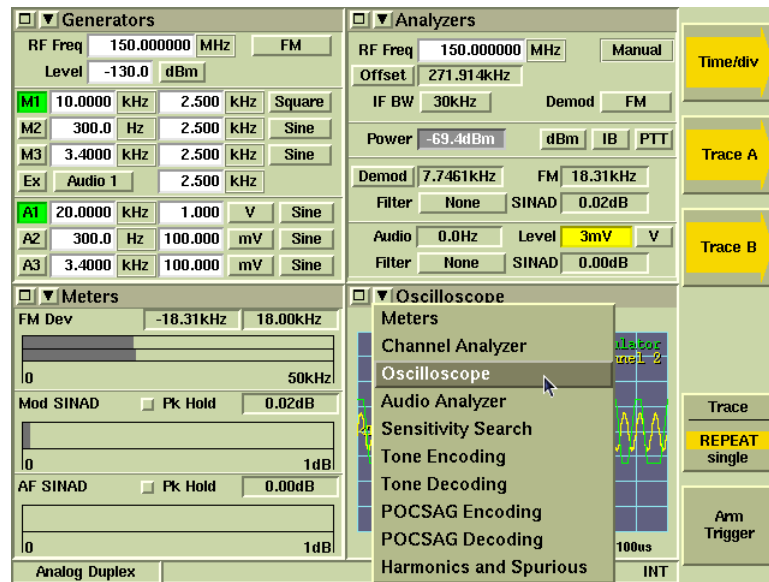

Fig. 6-33 Accessing the Oscilloscope

6.5.3 Oscilloscope Tile Layout

The Scope can be viewed in minimized and maximized view. The soft keys on the right side of the display provide access to Scope parameters and functions not shown on the main tile.

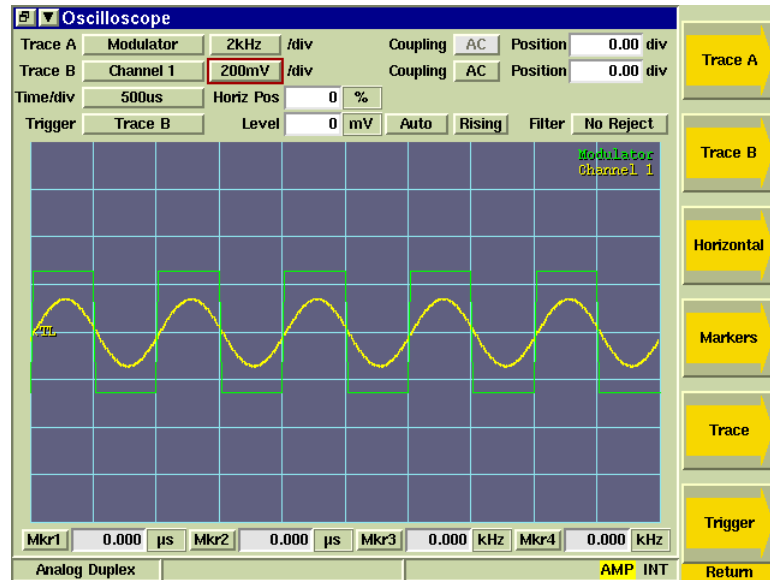

Fig. 6-34 Oscilloscope Tile - Maximized View

6.5.4 Field Definitions

6.5.4.A Trace A/Trace B Source

The Trace A and Trace B Source drop-down menus select the signal source for each trace. Only one trace can be set to an internal signal source (i.e., Audio, Demod) at one time.

6.5.4.A.1 Off

No signal source is selected.

6.5.4.A.2 Channel 1/Channel 2

Selects the Test Set's Channel 1 or Channel 2 Connectors as signal source for Scope trace.

6.5.4.A.3 Audio/Audio Filtered

Selects the Test Set's Audio 1 or Audio 2 Connector as the signal source for the Scope trace. Audio Filtered includes a filter in the signal path.

Refer to section titled RF Input/Output Connectors in Chapter 3 for information on selecting the Audio Input connector.

6.5.4.A.4 Demod/Demod Filtered

Selects the Test Set's Function Gen/Demod Out Connector as the signal source for the Scope trace. Demod Filtered includes a filter in the signal path.

6.5.4.A.5 Modulator

Routes the modulation generator source signal to the Scope. IQ Gen Files are not a supported Scope Modulation source.

6.5.4.B ***n/div***

This drop-down menu selects the vertical scale of the trace. The scale can also be increased or decreased using the Expand/Contract Soft Keys. The scale unit of measurement changes according to type of measurement being performed.

6.5.4.C **Coupling**

The Coupling drop-down menu selects how the signal is connected to the Test Set.

AC	Signal is connected to the Test Set through a capacitor that removes the CD component.
DC	Signal is connected directly to the Test Set.
GND	Signal is grounded; GND is typically used to set a reference.

6.5.4.D **Position**

The Position field adjusts the vertical position of trace on the display field.

6.5.4.E **Time /div**

The Time/div drop-down menu sets the Scope's timebase repetition. The timebase repetition rate setting can be increased or decreased by using the Expand or Contract Soft Keys.

6.5.4.F **Trigger Horizontal Position**

The Trigger Horizontal Position field is enabled when Channel 1 or Channel 2 is selected as the Source for Trace A/B.

6.5.4.G **Trigger Source**

The Trigger drop-down menu selects the Trigger source as Trace A, Trace B or the External Trigger Signal Input Connector.

6.5.4.H **Trigger Level**

The Level field sets a voltage or percent value for the trace trigger level. The trigger level point is indicated by a green TL flag on the left of the display.

6.5.4.I **Trigger Mode**

The Trigger Mode toggle button selects the Trigger mode of operation. When NORMAL is selected the trace is triggered when the trace passes through the Trigger Level value. When AUTO is selected the trace free runs at the rate determined by the Time /div setting.

6.5.4.J **Trigger Edge**

The Trigger Edge toggle button selects how the trigger is activated. When RISING is selected the trace triggers when the trace passes the trigger level as it increases in value. When FALLING is selected the trace triggers when the trace passes the trigger level as it decreases in value.

6.5.4.K **Trigger Filter**

Selects amount of noise, if any, to be filtered from the trigger path.

No Reject	No noise is filtered from trigger path.
Noise Reject	Filters medium level noise from trigger path.
HF Reject	Filters High Frequency noise from trigger path.

6.5.5 Soft Key Definitions

6.5.5.A Trace A/Trace B Soft Keys

The Trace A and Trace B soft keys access additional soft keys that adjust scaling and positioning of Trace A and Trace B. The up/down arrow keys move the signal trace up or down on the display, simultaneously adjusting the Position value. The Expand/Contract Soft Keys adjust the height of the signal trace, which can also be changed using the n/div drop-down menu.

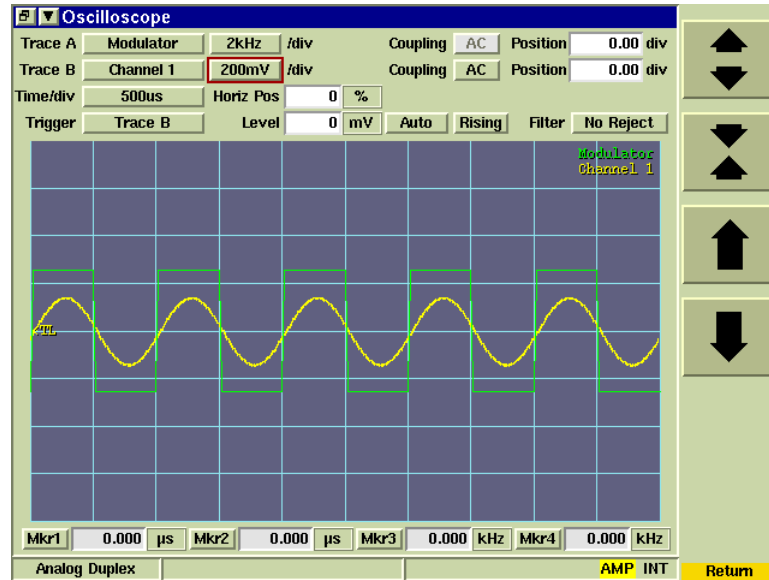

Fig. 6-35 Oscilloscope Tile - Vertical Settings

6.5.5.B Horizontal Soft Key

The Horizontal Soft Key accesses a group of soft keys that adjust the horizontal scaling and position of the signal on the graph field. The horizontal scale can be adjusted using the Expand/Contract Soft Keys or by changing the Time /div setting. When the Expand/Contract Soft Keys are pressed the Time/div value is simultaneously updated.

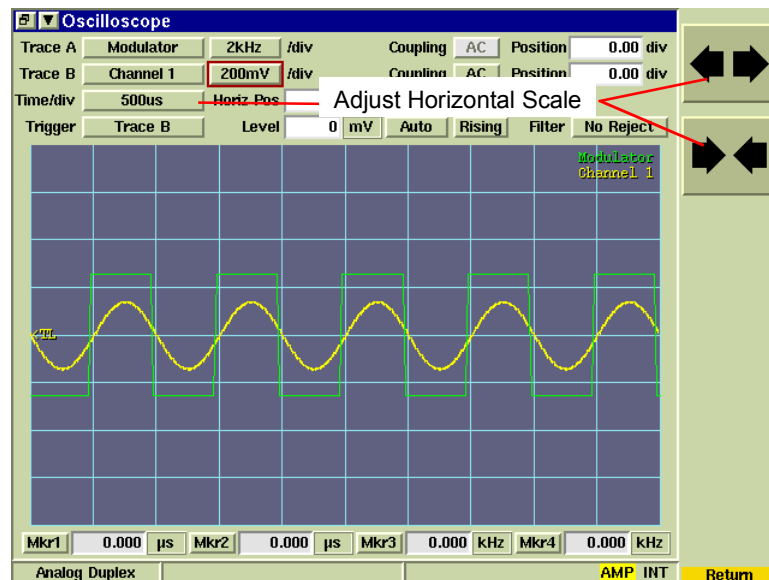

Fig. 6-36 Scope Expand/Contract Soft Keys

6.5.5.C Marker Fields and Soft Keys

Marker functionality is described in the Markers section located at the beginning of this chapter.

6.5.5.D Trace Soft Key

The Trace Soft Key accesses trace display control functions to allow users to obtain average and peak measurements and to capture traces being displayed on the plot field.

6.5.5.D.1 Trace Color

Trace types being displayed on the graph are listed in the upper right corner of the graph field. The traces are color-coded to identify trace types.

Green	Live and Averaged Trace A
Yellow	Live and Averaged Trace B
Blue	Captured Trace A
Purple	Captured Trace B

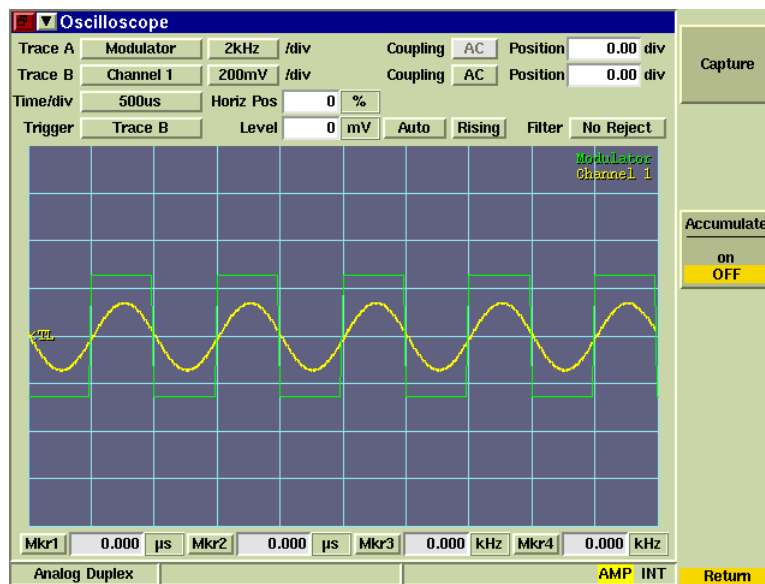

Fig. 6-37 Oscilloscope Trace Soft Keys

6.5.5.E Capture Soft Key

When Capture Soft Key is pressed the current trace is held on the display. To resume normal sweep operation press the Clear Soft Key.

A captured trace can be saved by pressing the HOLD Key, then selecting the Save As Soft Key.

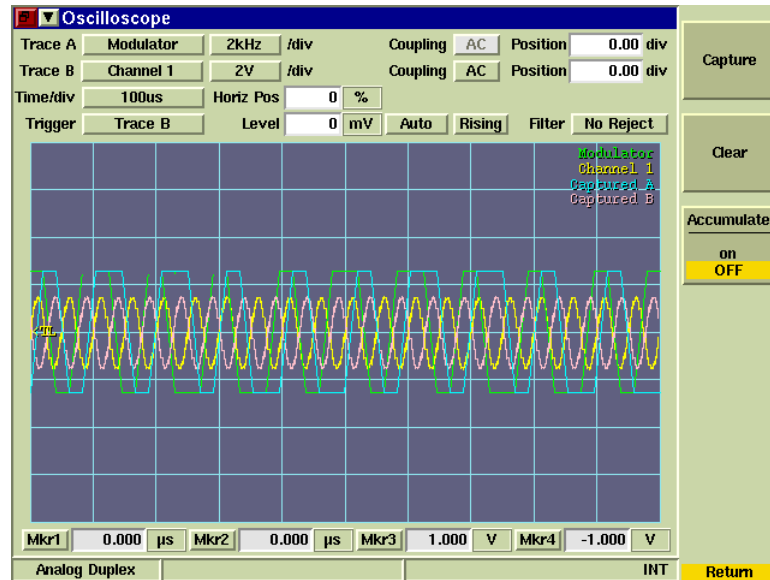

Fig. 6-38 Oscilloscope Captured Traces

6.5.5.F Clear Soft Key

Clears the current captured trace and resumes display of Live trace. This soft key is only visible when a trace is in 'Captured' state.

6.5.5.G Accumulate Soft Key

When the Accumulate Soft Key is set to ON, the trace is not cleared at the end of each sweep, showing each subsequent trace on the display. The accumulation continues until the Accumulate Soft Key is turned OFF. OFF clears the accumulated traces and resumes display of a single trace. This soft key is accessed by pressing the Trace Soft Key.

6.5.5.H Trigger Soft Key

The Trigger Soft Key accesses features to control how the trace is triggered.

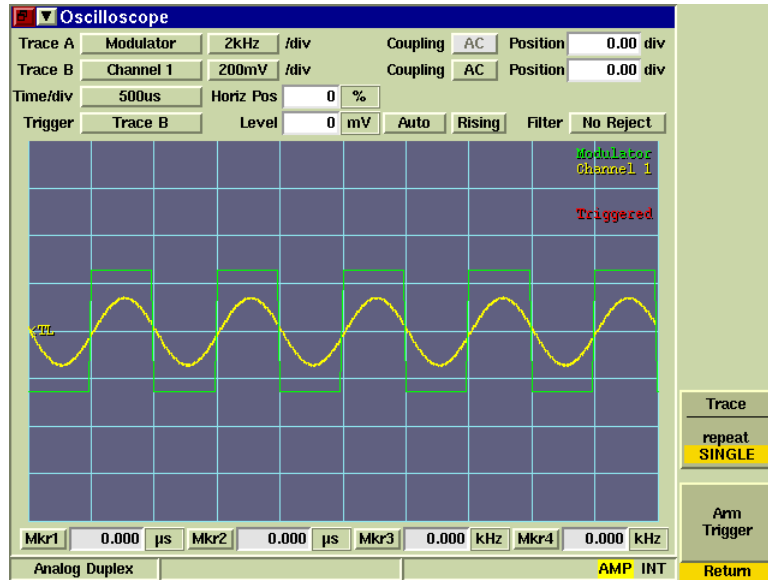

Fig. 6-39 Oscilloscope Trigger Soft Keys

6.5.5.I Trace Soft Key

The Trace Trigger Soft Key is accessed by pressing the Trigger Soft Key.

When REPEAT is selected the trace sweeps continuously as long as trigger conditions are met.

When SINGLE is selected the trace triggers a single sweep the next time trigger conditions are met.

6.5.5.J Arm - Trigger Soft Key

When Trace - Repeat/Single is set to SINGLE and the Arm - Trigger Soft Key is pressed, the trace triggers a single sweep the next time trigger conditions are met. After the sweep is obtained, the Trigger state becomes inactive until the Arm - Trigger Soft Key is pressed again. This soft key is accessed by pressing the Trigger Soft Key.

6.6 DIGITAL MULTIMETER

The DMM (Digital Multimeter) Tile displays the results of resistance measurements and AC and DC current and voltage measurements. The DMM Tile is selected from any of the measurement tile drop-down menus. DMM measurement limits are configured on the DMM Limits Configuration Tile.

6.6.1 DMM Test Tile

The DMM (Digital Multimeter) Tile displays the results of resistance measurements and AC and DC current and voltage measurements. The DMM Tile is selected from any of the measurement tile drop-down menus.

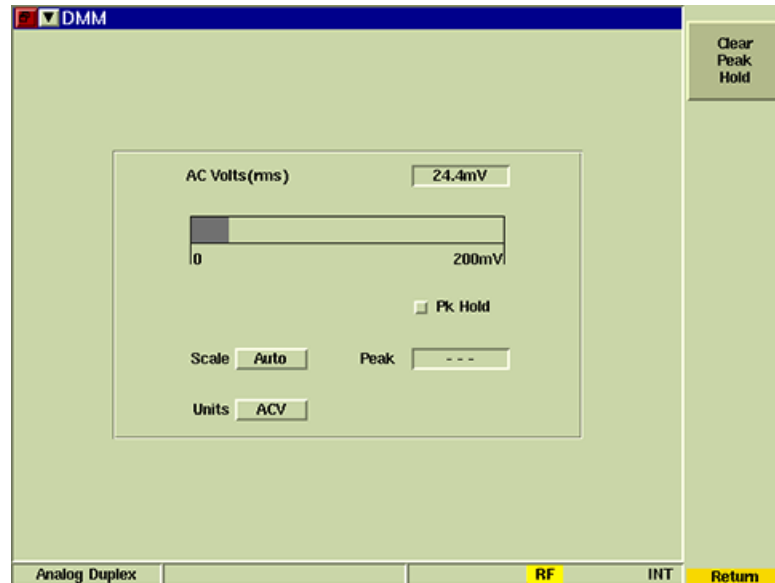

Fig. 6-40 DMM Tile - Maximized View

6.6.1.A Field/Soft Key Definitions

6.6.1.A.1 Scale

The scale of the bar graph is selected from the Scale drop-down menu. Available settings are Auto-ranging (Auto) or a fixed value. The selected scale value is displayed below the bar graph.

Auto-ranging (Auto) is not valid when utilizing an external shunt to measure Current greater than 2 Amps. The scale must be set manually to the "20 A" selection when performing measurements that exceed 2 Amps.

6.6.1.A.2 Units

Selects the type of measurement to be performed.

6.6.1.A.3 Bar Graphs

The bar graphs provide a graphic representation of the measurement being performed. The graph's horizontal scale is selected from the Scale drop-down menu.

6.6.1.A.4 Peak (Pk) Hold

Selecting the Peak Hold radio button allows the peak value of measurements to be captured and updated as new peaks occur. The peak value is shown on the bar graph and in the Peak digital readout field.

6.6.1.A.5 Peak Measurement

Shows the peak value measured. The peak reading can be reset by using the Peak Reset ALL Soft Key. The reset operation also resets the peak reading on the bar graph.

6.6.1.A.6 Peak Reset Soft Key

Clears and resets active peak hold measurement.

6.6.1.A.7 Shunt Installation Prompt

When ACA or DCA measurements are being performed, and 20 AMP Scale is selected, a prompt dialog box is displayed. When the shunt has been installed, press Continue to close dialog box.

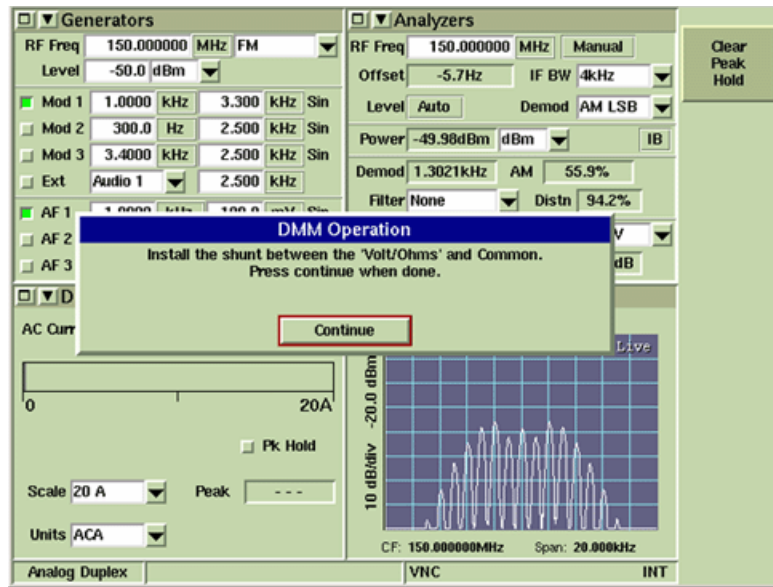

Fig. 6-41 DMM Shunt Installation Prompt Dialog Box



Fig. 6-42 Shunt Installed

6.6.1.A.8 Enabled/Disabled Toggle Button

The Enable/Disable Toggle button turns defined limits on and off. Default values are applied if values are not defined by user.

6.6.2 DMM Limits Configuration Tile

The DMM Limits Configuration Tile sets Pass/Fail limit parameters for resistance measurements and AC and DC current and voltage measurements.

Fig. 6-43 DMM Limits Configuration Tile

6.6.2.A Field Definitions

6.6.2.A.1 AC Volts Upper & Lower Limits

The AC Volts Upper and Lower Limit fields define limit values for AC Volt measurements.

6.6.2.A.2 DC Volts Upper & Lower Limits

The DC Volts Upper and Lower Limit fields define limit values for DC Volt measurements.

6.6.2.A.3 AC Amps Upper & Lower Limits

The AC Amps Upper and Lower Limit fields define limit values for AC Amp measurements.

6.6.2.A.4 DC Amps Upper & Lower Limits

The DC Amps Upper and Lower Limit fields define limit values for DC Amp measurements.

6.6.2.A.5 Ohms Upper & Lower Limits

The Ohms Upper and Lower Limit fields define limit values for Ohm measurements.

6.6.2.A.6 Averages

The number of measurements taken to calculate the average values can be set individually using the Measurement Averages fields. Valid range values are from 1 to 250.

6.6.2.A.7 Enabled/Disabled Toggle Button

The Enable/Disable Toggle button turns defined limits on and off. Default values are applied if values are not defined by user.

6.7 OPTIONAL INSTRUMENT FUNCTIONS

6.7.1 Audio Analyzer (390XOPT055)

The Audio Analyzer is an optional feature (390XOPT055) that allows users to evaluate the audio frequency band of a demodulated or externally input signal. The Audio Analyzer is only available when the Audio Analyzer Option (390XOPT055) has been installed in the Test Set.

6.7.1.A Basic Settings

The frequency span of the display must include the AF Frequency being examined. The Reference Level of the display must be set so that the AF signal level falls within the display area.

6.7.1.B Accessing the Audio Analyzer

The Audio Analyzer is accessed from the drop-down menus on System Test Measurements Tiles.

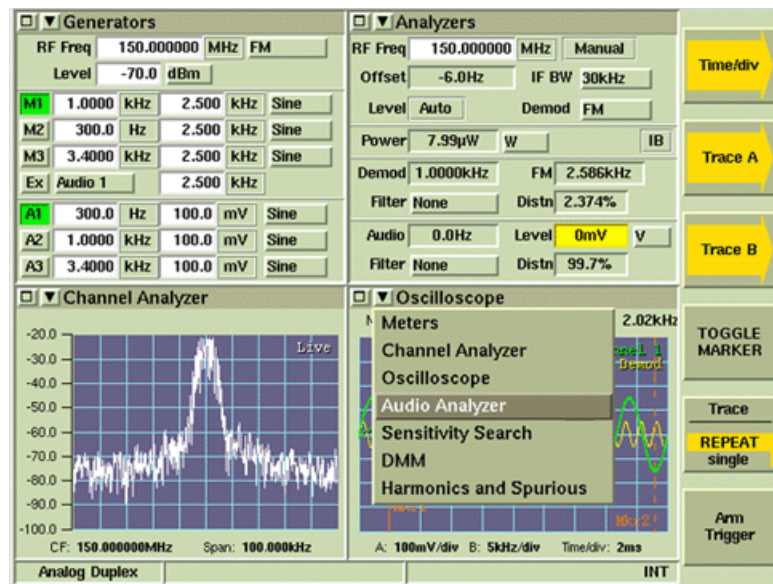

Fig. 6-44 Accessing Audio Analyzer

6.7.1.C Audio Analyzer Tile Layout

The Audio Analyzer can be viewed in minimized and maximized view. Soft Keys on the right side of the display provide access to settings not available on the main tile.

NOTE

Some of the images in this section show option enabled fields. These fields are not visible unless the applicable option is installed in the Test Set.

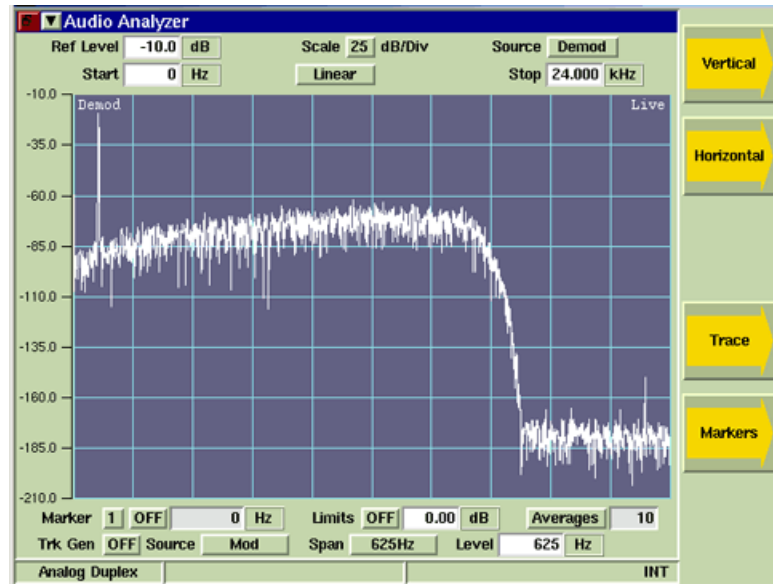

Fig. 6-45 Audio Analyzer Tile - Maximized View

6.7.1.D Field/Soft Key Definitions

6.7.1.D.1 Reference Level

The Reference Level sets the top value on the display graph. Power levels can be measured at any point on the trace in conjunction with the Scaling dB/div setting. The Reference Level can be set to any value within the specified range. The Reference Level is set by:

- Using the Expand and Contract Soft Keys to make step changes.
- Selecting the data field and using the Rotary Control Knob to adjust the level.
- Selecting the data field and using the Data Entry Input Keys to enter specific level.

6.7.1.D.2 Scaling dB

The Scaling drop-down menu selects from a range of 1, 2, 5, or 10. The scaling value (dB/div) can then be increased or decreased using the Expand or Contract Soft Keys.

6.7.1.D.3 Input Source

The Input Source drop-down menu selects Demod or Audio as the filtered signal source. When a filter is selected, the signal source is routed through the selected filter. Filter selection is made on the Analyzers Tile of the active operating Analog system. When the Tracking Generator is enabled, user defined filters are not available.

6.7.1.D.4 Start

Defines the start frequency of the frequency span. The maximum span is 0 to 24000 Hz; horizontal scale values must be within this range.

6.7.1.D.5 Stop

Defines the stop frequency of the frequency span. The maximum span is 0 to 24000 Hz; horizontal scale values must be within this range.

6.7.1.D.6 Linear/Log Scale Toggle Button

The Linear/Log toggle button changes the display between Linear and Logarithmic scaling.

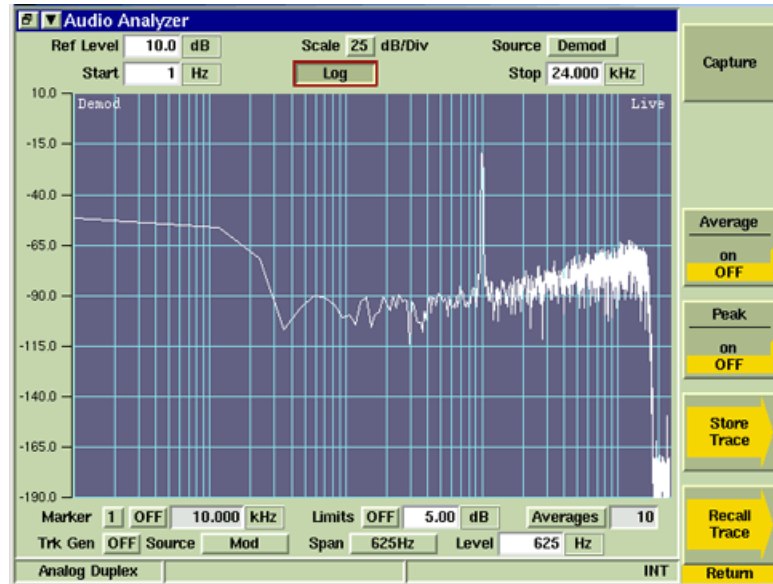

Fig. 6-46 Log Scaling Selected

6.7.1.D.7 Averages

The Averages toggle button Enables/Disables Average measurements. The Averages field defines the number of signal traces used to calculate average measurements. Refer to Trace Soft Key for additional information on Average measurements.

6.7.1.D.8 Vertical Soft Key

The Vertical Soft Key accesses scaling and positioning controls that adjust the trace's position on the display. The signal trace can also be adjusted by changing the Reference Level or Scaling dB values.

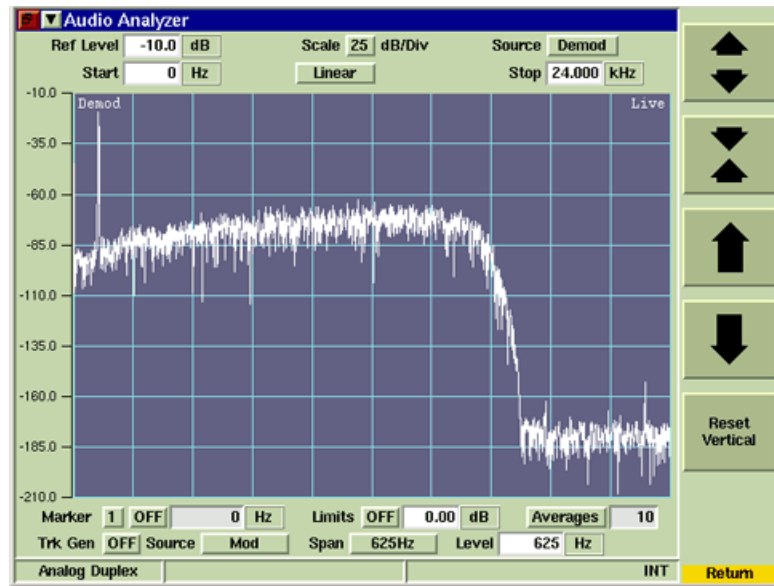

Fig. 6-47 Audio Analyzer - Ref Level and Scale Settings

6.7.1.D.9 Reset Vertical Soft Key

Resets vertical setting to position trace vertically in the center of the graph field.

6.7.1.D.10 Horizontal Soft Key

The Horizontal Soft Key accesses a group of soft keys that adjust the horizontal scaling and position of the signal on the graph field.

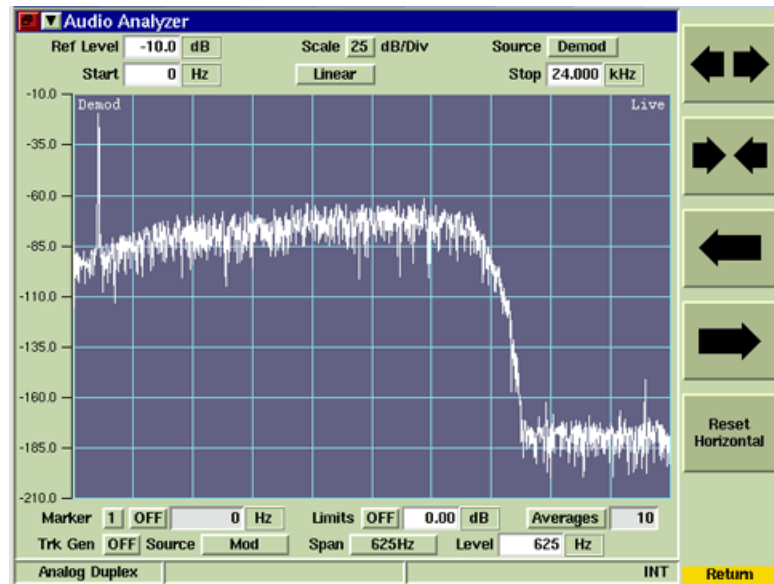

Fig. 6-48 Audio Analyzer Start and Stop Frequency Setting

6.7.1.D.11 Reset Horizontal Soft Key

Resets Start and Stop frequency values to frequency range of Test Set.

6.7.1.D.12 Markers Soft Key

Marker functionality is described in the section titled Markers, in Chapter 6, Radio Test Instruments.

6.7.1.D.13 Toggle Marker Soft Key

Refer to section titled Toggle Marker Soft Key in Chapter 6, Radio Test Instruments.

Marker functionality is described in the section titled Markers, in Chapter 6, Radio Test Instruments.

6.7.1.D.14 Trace Soft Key

The Trace Soft Key accesses trace display control functions to allow users to obtain average and peak measurements and to capture traces being displayed on the plot field.

Trace Color

Trace types being displayed on the graph are listed in the upper right corner of the graph field. The traces are color-coded to identify trace types.

- Live traces are White.
- Peak hold traces are Red.
- Averaged traces are Yellow.
- Captured traces are Green.

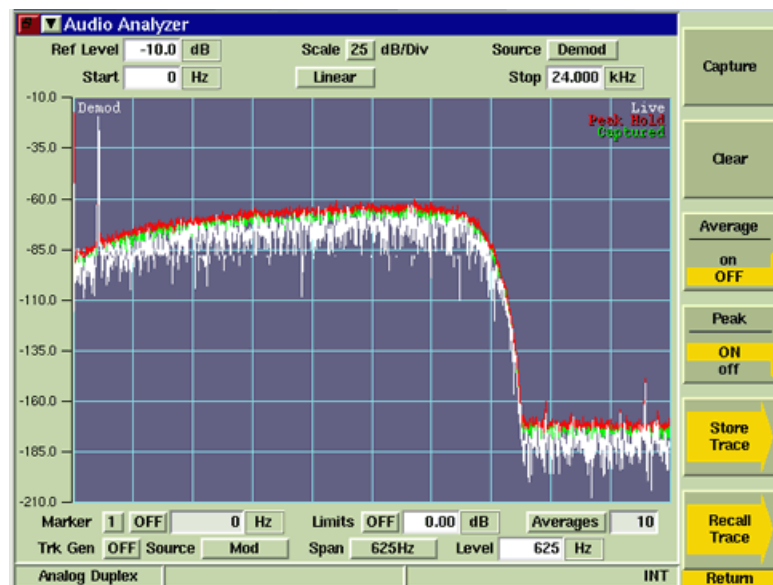

Fig. 6-49 Audio Analyzer Trace Soft Keys

6.7.1.D.15 Capture Soft Key

When Capture Soft Key is pressed the current trace is held on the display. To resume normal sweep operation press the Clear Soft Key.

A captured trace can be saved by pressing the HOLD Key, then selecting the Save As Soft Key.

6.7.1.D.16 Clear Soft Key

Clears the current captured trace and resumes display of Live trace. This soft key is only visible when a trace is in 'Captured' state.

6.7.1.D.17 Peak Hold Soft Key

When Peak Hold ON is selected, the maximum value at each frequency point is displayed to produce the RED Max Hold trace. This trace is cleared by selecting Peak Hold OFF. Peak Hold must be reset (toggled ON/OFF) when Average readings are Enabled/Disabled. The white Live trace is also displayed and can be averaged depending on the current setting. This soft key is accessed by pressing the Trace Soft Key.

6.7.1.D.18 Average Soft Key

When the Average Soft Key is ON, the trace is calculated by averaging the number of measurements defined in the Averages field. The calculated value is a rolling average or a one-shot average as defined on the Trigger Tile using the Repeat Soft Key and Single Soft Key. A yellow progress indicator is displayed in the upper right corner of the graph field while the average reading is accumulating. This soft key is accessed by pressing the Trace Soft Key.

6.7.1.D.19 Store Trace Soft Key

The Store Trace Soft Keys opens a dialog box that allows a user to save a captured signal trace. The signal must be in "Captured" state before it can be saved using the Store Trace function. Refer to the Capture Soft Key for information on capturing a signal trace.

6.7.1.D.20 Recall Trace Soft Key

The Recall Trace Soft Key opens a dialog box that allows the user to load stored trace data.

6.7.1.E Audio Analyzer Trace Limits

Audio Analyzer Trace limits allows users to set visual limits above and below the desired target level. This function allows the user to quickly determine if the signal received from the UUT falls within a desired target level range.

6.7.1.E.1 Limits On/Off Toggle Button

The Limits On/Off Toggle Button enables the Audio Analyzer upper and lower signal trace limits.

6.7.1.E.2 Limits Value

Limit trace position is defined by entering a value in the Limits Value field. Upper and lower limit traces are offset from the signal by the value defined in the Limits Value field. For example, if the Limit Value is set to 5.0 dB, the Upper Trace is positioned 5.0 dB above the signal and the Lower Trace is positioned 5.0 dB below the signal.

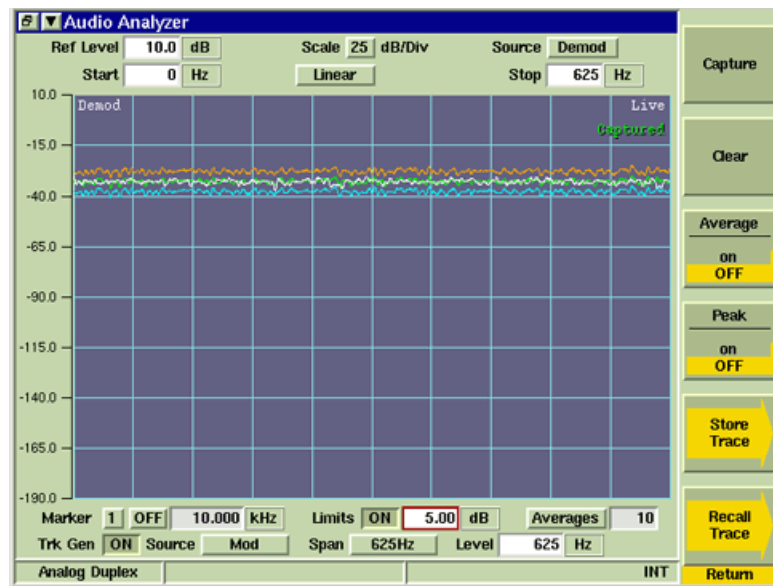

Fig. 6-50 Audio Analyzer - Trace Limits Enabled

6.7.1.E.3 Using Stored Trace with Trace Limits

The Store Trace function can be used in combination with Trace Limits to evaluate multiple radios that operate within the same specifications. To configure the Test Set for Audio Limits Analysis:

STEP

PROCEDURE

1. Capture and Store a baseline signal trace.
2. Define the Limits Value and set Limits to ON to establish a target upper and lower limit.
3. Press the Clear Soft Key to remove the stored signal trace (upper and lower Limits remain).
4. Transmit signal from UUT to Test Set. Adjust UUT until signal is within defined trace limits of baseline signal trace.

6.7.2 Simulcast Analysis (390XOPT210)

The Simulcast Analysis Option (390XOPT210) enables Tracking Generator functionality on the Audio Analyzer. The Audio Tracking Generator plots the frequency response of the external audio or demod audio path. The Simulcast Analysis Option can be used to evaluate pre-emphasis and de-emphasis curves of the transmit and receive audio paths.

The examples below show the Simulcast Analysis Option being used to test a radio's receive frequency response (de-emphasis curve) and transmit frequency response (pre-emphasis curve). Both examples show Markers 1 and 2 enabled and positioned at 1000 Hz and 2000 Hz in order to evaluate signal strength at these points on the signal. Both examples show an approximate 6 dB variance in signal strength between 1000 Hz and 2000 Hz.



Fig. 6-51 Audio Analyzer - Rx Bandpass Sweep

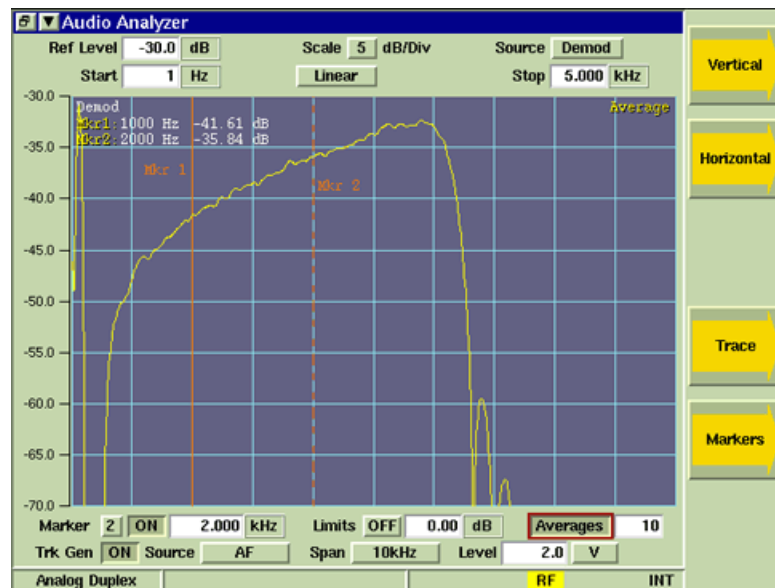

Fig. 6-52 Audio Analyzer - Tx Bandpass Sweep

6.7.2.A Trk Gen Toggle Button

The Trk Gen Toggle Button turns the Tracking Generator On and Off. When the Tracking Generator is ON, either the M1 or A1 Generator is used to produce the Tracking Generator Output signal. When the Tracking Generator Output Source is set to Mod, M1 is used to generate the Tracking Generator Output signal. When the Tracking Generator Output Source is set to AF, A1 is used to generate the Tracking Generator Output signal. If A1 or M1 is already enabled, the Tracking Generator signal overrides the signal currently configured on these generators.

6.7.2.B Span Drop-Down Menu

The Span drop-down menu is enabled when the Simulcast Analysis Option (390XOPT210) is installed in the Test Set. Span selects the horizontal scaling of the plotted signal. Once Span is selected, the Stop Frequency Field can be used to focus on a specific section of the signal. For example, Span can be set to 9.6 kHz, then the Stop Frequency can be adjusted to 100.0 Hz. The maximum Stop Frequency is defined by the Span value.

6.7.2.C Tracking Generator Source

The Tracking Generator Source drop-down menu selects the output source of the Tracking Generator signal.

When AF is selected, the Tracking Generator Output signal is routed to the Test Set's Fctn GEN/Demod Out Connector.

When MOD is selected, the Tracking Generator Output signal is routed through the modulator to the selected RF Out Connector (GEN or T/R).

6.7.2.D Tracking Generator Level

The Tracking Generator Level defines the Tracking Generator Output signal level.

6.7.3 Analyzer OBW & Power Between Markers Option (390XOPT064)

The Analyzer Occupied Bandwidth (OBW) and Power Between Marker Option provides the user with added features for evaluating the power of a received signal. The Power Between Markers function allows the user to evaluate the total power level of a received signal between Marker 1 and Marker 2 on the Channel Analyzer and Spectrum Analyzer. The Power Measurement (Pwr:.) is displayed under the Delta Measurement when Marker 1 and Marker 2 are enabled.

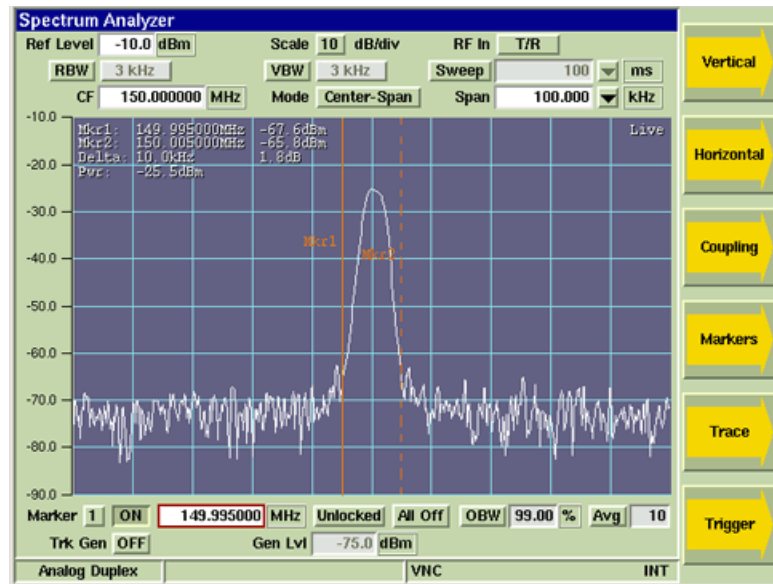

Fig. 6-53 Spectrum Analyzer - Power Between Markers Measurement

The Occupied Bandwidth (OBW) Function measures the frequency band that contains a specified percentage of total signal power, centered on the assigned Center Frequency (CF). The OBW function is enabled/disabled by pressing the OBW Toggle Button. When enabled, the OBW Power and Bandwidth measurements are displayed on the Analyzer graph.

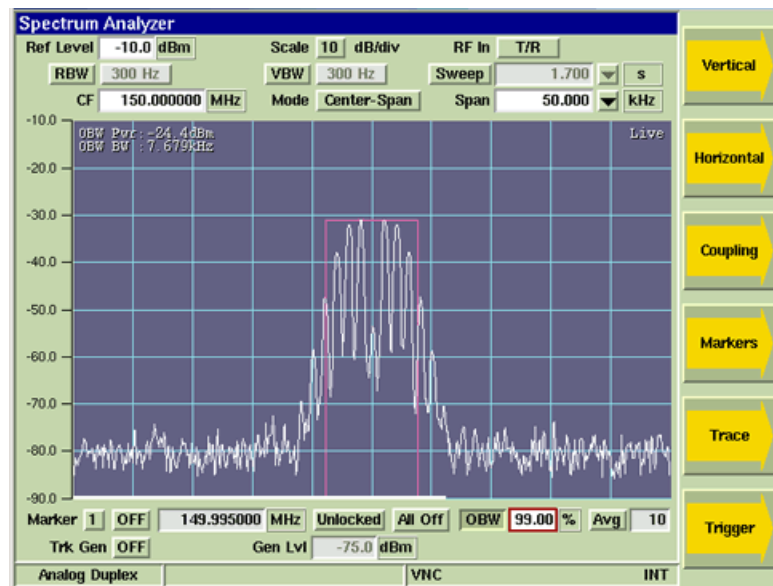

Fig. 6-54 Spectrum Analyzer - Occupied Bandwidth at 99%

6.7.3.A Field Definitions

6.7.3.A.1 OBW Field

The OBW field defines the percentage of a signal's power over which Occupied Bandwidth measurements are performed.

6.7.3.A.2 OBW Pwr

The OBW Power measurement indicates the power level of the signal across the Occupied Bandwidth.

6.7.3.A.3 OBW BW

The OBW Bandwidth measurement indicates the amount of Bandwidth occupied by the percentage of signal power as defined by the OBW field.

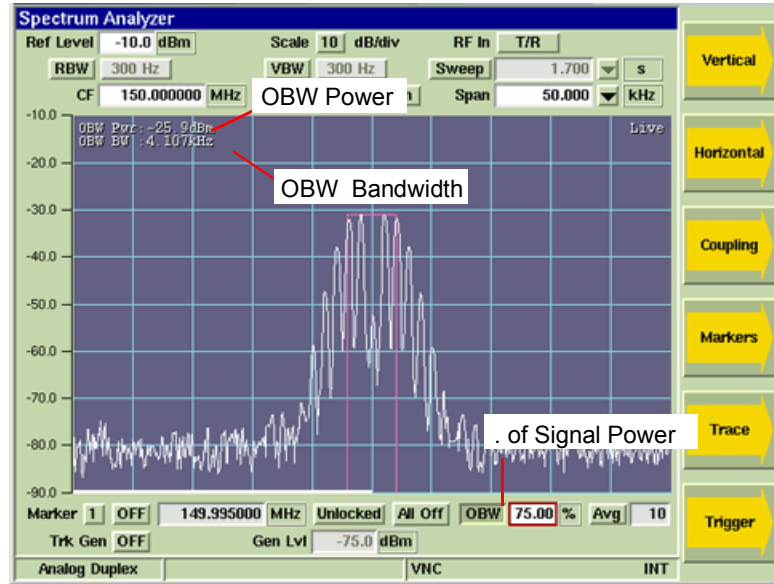

Fig. 6-55 Spectrum Analyzer - Occupied Bandwidth at 75%

6.7.4 Spectrum Analyzer Tracking Generator Option (390XOPT061)

The Tracking Generator Option (390XOPT061) generates a carrier wave that sweeps synchronously with the Spectrum Analyzer RF Receiver. The carrier wave can be applied to components or systems, and the output analyzed to display the frequency response of the device under test.

The Trk Gen drop-down menu Enables the Tracking Generator when Gen or TR is selected. Selecting OFF from this drop-down menu disables the Tracking Generator.

NOTE

Switching between Spectrum Analyzer and Test Mode disables the Tracking Generator.

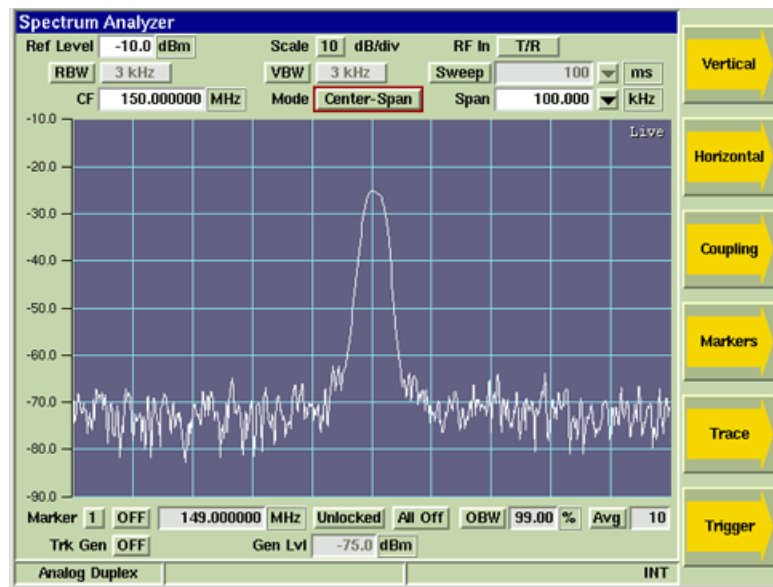

Fig. 6-56 Spectrum Analyzer Tile - Tracking Generator Parameters

6.7.4.A Field Definitions

6.7.4.A.1 Trk Gen Menu

The Trk Gen drop-down menu Enables the Tracking Generator when Gen or TR is selected. Selecting OFF from this drop-down menu disables the Tracking Generator.

6.7.4.A.2 Gen Lvl

The Gen Lvl Field provides quick access to set the Generator power level. This field is only available on the Spectrum Analyzer Tile when the Tracking Generator Option (390XOPT061) is installed in the Test Set.

Chapter 7 - Analog Duplex System

7.1 INTRODUCTION

The 3900 Analog Duplex System tests mobile radio transmitters, receivers and transceivers. The tests can be simple functionality tests or more detailed tests such as testing transmitter power output, broad band and narrow band; receiver sensitivity; AM and FM modulation and demodulation performance; distortion level and SINAD.

The Analog Duplex System includes the following test functions:

- AM and FM Signal Generator
- RF Signal Analyzer
- Multiple AF Signal Generators
- Multiple AF Modulators
- AF Measurement
- Modulation Measurement
- Oscilloscope for examining external and internal signals
- Full Duplex operation
- Spectrum Analyzer and Channel Analyzer

This chapter explains how to use the Analog Duplex System. Refer to [Chapter 3, Test Set Operation](#), for general operation of the Test Set. This chapter includes the following:

- Description of the Analog Duplex System and a diagram of a common test setup.
- Describes how to access the Analog Duplex System.
- Describes how to navigate Analog Duplex System Tiles.
- Describes the layout and information provided on Analog Duplex Tiles.
- Explains the TEST Tiles.

7.2 ACCESSING ANALOG DUPLEX SYSTEM

To select the Analog Duplex System when operating in Test Mode:

STEP PROCEDURE

1. Press CONFIG Key twice to access the System/Config Menu.
2. Select Systems, Analog Duplex from the Systems Menu.
3. Analog Duplex system loads, configured with the last used operating settings.

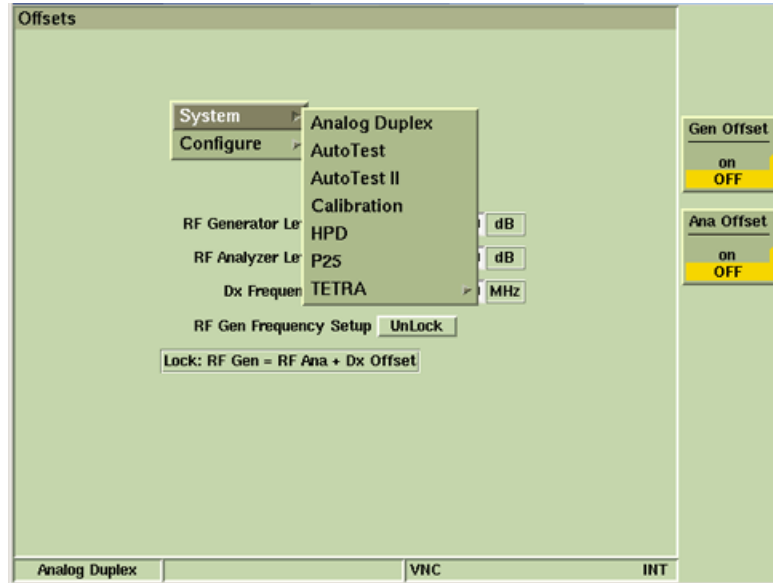

Fig. 7-1 Selecting Analog Duplex System

7.3 ANALOG DUPLEX TILE LAYOUT

Analog Duplex System Tiles can be displayed in a maximized or minimized view. When minimized, the display is divided into four quadrants which can be configured display different test tiles.

The example shows the 3900 Analog Duplex System in minimized view. The Generators Tile is selected and the soft keys displayed on the right are relevant to the Generators Tile.

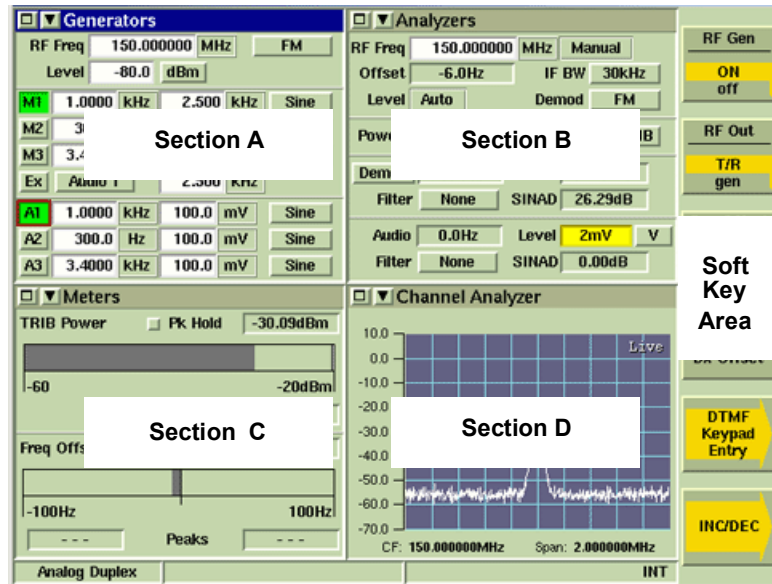

Fig. 7-2 Analog Duplex System - TEST Mode - Minimized Tiles

- Section A can be configured to display the Generators Tile, Meters Tile, Channel Analyzer or Oscilloscope Tiles.
- Section B can be configured to display the Analyzers Tile, Meters Tile, Channel Analyzer or Oscilloscope Tiles.
- Section C and D can be configured to display various measurement tiles as well as the Channel Analyzer or Oscilloscope Tiles. Measurement tile selection depends on the options installed in the Test Set.
- The Soft Keys menu changes according to the tile selected on the display. The example above shows the soft keys associated with the Generators Tile, which is currently selected.
- The Information Bar displays the operating System title and other operational information.
- A specific Tile can be displayed in more than one section if required. For example, the Meters Tile may be selected for Section C and D so that all of the meters are visible in minimized view (3 meters in each section).

7.4 CONFIGURATION TILES

7.4.1 AF Limits Configuration Tile

The AF Limits Configuration Tile sets Pass/Fail limit parameters for AF Measurements. Refer to section titled Limits in Chapter 3 for information on defining limits.

Fig. 7-3 AF Limits Configuration Tile

7.4.1.A Field Definitions

7.4.1.A.1 AF Level Upper & Lower Limits

The AF Level Upper and Lower Limit fields define limit values for AF Level measurements.

7.4.1.A.2 Distortion Upper Limit

The Distortion Upper limit field sets limit value for Distortion measurements.

7.4.1.A.3 SINAD Lower Limit

The SINAD Lower limit field sets limit value for SINAD measurements.

7.4.1.A.4 SNR Upper & Lower Limits

The SNR Upper and Lower limit fields set limit values for SNR measurements.

7.4.1.A.5 Hum & Noise Upper & Lower Limits

The Hum & Noise Upper and Lower limit fields set limit values for Hum & Noise measurements.

7.4.1.A.6 Audio Frequency Upper & Lower Limits

The Audio Freq Upper and Lower limit fields set limit values for AF measurements.

7.4.1.A.7 Enabled/Disabled Toggle Button

The Enable/Disable Toggle button turns defined limits on and off. Default values are applied if values are not defined by user.

7.4.2 AF Measurements Configuration Tile

The AF Measurements Configuration Tile defines parameters used to measure audio signals.

Fig. 7-4 AF Measurements Configuration Tile

7.4.2.A Field/Soft Key Definitions

7.4.2.A.1 MIC Phantom Power

The MIC/ACC Connector provides a power source for condenser microphones. The Mic Phantom Power drop-down menu turns the power source for the condenser microphone On or Off.

7.4.2.A.2 Filter

Selects type of filter to be included in the signal path.

7.4.2.A.3 Psoph Filter

Psoph Filter menu selects whether the CMESS or the CCITT Psophometric weighting filter are used when the Psoph filter is selected from any of the Filter selection drop-down menus. Psoph filters are typically used for SINAD measurements, either Demod or Audio.

7.4.2.A.4 300 Hz Filter Type

Selects type of 300 Hz filter to be included in the signal path.

- Standard: Highpass 300 Hz Low-Q Filter
- Sharp: Highpass 300 Hz high-Q Filter

7.4.2.A.5 Hum & Noise Reference Level

Sets Reference Level for Hum & Noise measurements.

7.4.2.A.6 Loudspeaker

The Loudspeaker menu selects the signal sent to the internal loud speaker.

7.4.2.A.7 Int Load

Selects either the 10 kOhm or 600 Ohm internal load to be applied at the Audio 1 or Audio 2 Input.

7.4.2.A.8 External Load

The Ext Load toggle button enables/disables the use of an external load. The 3900 allows the user to define an external load value which is applied at the Audio 1 or Audio 2 Input ports. The external load value is applied to AF Level dBm or Watt measurements when the External Load is enabled.

External Load is disabled when Balanced is selected as the Audio Input Source.

7.4.2.A.9 Audio Level Units

Sets the unit of measure for AF Level measurements to V, dBV or dBr. The dBr setting creates a zero reference point at the time the unit of measurement is changed.

For example, if the current audio level reading on the AF Meter is -12.47 (dBm) and the Level unit of measure is changed to dBr, the Audio level reading immediately updates to 0.00 dBm. Subsequently, if the input audio level drops to -13.47 dBm, the level on the AF Meter indicates -1.00 dBr, the difference between the reference level and current level. To reset the reference level, switch the unit of measurement to another value, then re-select dBr.

The available Unit of measurement is limited by the selected Source. For example, when Balanced is selected as the source option, V is not available as a unit of measurement.

7.4.2.A.10 Source

The Source field selects the source of the AF signal routed to the AF Analyzer.

7.4.2.A.11 Measurement Averages

The number of measurements taken to calculate the average values can be set individually using the Measurement Averages fields. Valid range values are from 1 to 250.

7.4.2.A.12 Hum & Noise/SNR Notch Filter Mode

Selects whether or not a notch filter is used for performing Hum and Noise/ SNR Measurements. When Hum and Noise/ SNR Notch Filter Mode is enabled the notch filter removes the sub audible CTCSS or CDCSS tone.

7.4.2.A.13 Hum & Noise/SNR Notch Filter Frequency

This field defines the frequency that is “notched out” when performing Hum and Noise/ SNR Measurements.

7.4.2.A.14 Hum & Noise/SNR Notch Filter Width

This field sets the Notch Filter Bandwidth used when performing Hum and Noise/ SNR Measurements.

7.4.2.A.15 SINAD/Distn Frequency

SINAD/Distn Frequency field sets the frequency at which SINAD or Distortion is measured.

7.4.2.A.16 SINAD/Distn Frequency Mode

When Unlocked mode is selected the frequency at which SINAD or Distortion is measured is defined by the SINAD/Distn Frequency Field. When Locked to M1 is selected, the frequency at which SINAD or Distortion is measured is locked to the Mod Generator 1 Frequency field on the Generators Tile.

7.4.2.A.17 SINAD/Distn Width

SINAD/Distn Width field sets the Notch Filter Bandwidth for SINAD and Distortion measurements.

7.4.3 DMM Limits Configuration Tile

The DMM Limits Configuration Tile sets Pass/Fail limit parameters for resistance measurements and AC and DC current and voltage measurements.

Fig. 7-5 DMM Limits Configuration Tile

7.4.3.A Field Definitions

7.4.3.A.1 AC Volts Upper & Lower Limits

The AC Volts Upper and Lower Limit fields define limit values for AC Volt measurements.

7.4.3.A.2 DC Volts Upper & Lower Limits

The DC Volts Upper and Lower Limit fields define limit values for DC Volt measurements.

7.4.3.A.3 AC Amps Upper & Lower Limits

The AC Amps Upper and Lower Limit fields define limit values for AC Amp measurements.

7.4.3.A.4 DC Amps Upper & Lower Limits

The DC Amps Upper and Lower Limit fields define limit values for DC Amp measurements.

7.4.3.A.5 Ohms Upper & Lower Limits

The Ohms Upper and Lower Limit fields define limit values for Ohm measurements.

7.4.3.A.6 Averages

The number of measurements taken to calculate the average values can be set individually using the Measurement Averages fields. Valid range values are from 1 to 250.

7.4.3.A.7 Enabled/Disabled Toggle Button

The Enable/Disable Toggle button turns defined limits on and off. Default values are applied if values are not defined by user.

7.4.4 DTMF Configuration Tile

The DTMF Configuration Tile contains parameters that are used by the Test Set's Generators when sending DTMF tones. DTMF Waveform must be selected on the Generators Tile for parameters to apply.

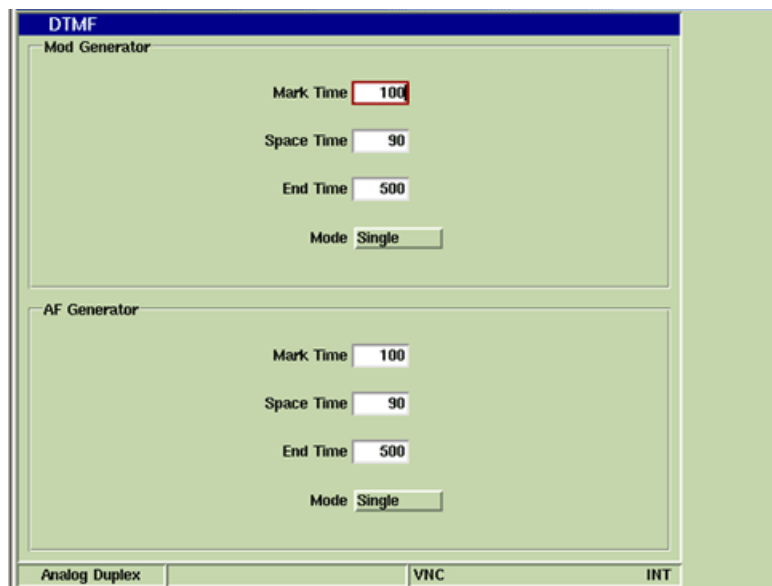

The screenshot shows a software interface for DTMF configuration. It features a title bar labeled 'DTMF' and two main sections: 'Mod Generator' and 'AF Generator'. Each section contains four parameters: 'Mark Time' (set to 100), 'Space Time' (set to 90), 'End Time' (set to 500), and 'Mode' (set to Single). The 'Mod Generator' section is highlighted with a red border around the 'Mark Time' field. At the bottom of the window, there are three buttons: 'Analog Duplex', 'VNC', and 'INT'.

Fig. 7-6 DTMF Configuration Tile

7.4.4.A Field Definitions

7.4.4.A.1 Mark Time

Mark Time sets time period in which the DTMF tone is ON. Defined in milliseconds.

7.4.4.A.2 Space Time

Space Time sets dead time between DTMF tones of a sequence. Defined in milliseconds.

7.4.4.A.3 End Time

End Time sets dead time between complete DTMF sequences. This parameter is only valid when Continuous Mode of operation is selected.

7.4.4.A.4 Mode

Mode selects how many DTMF pulses are sent (Single or Continuous).

7.4.5 Frequency List Setup Configuration Tile

The Frequency List Setup Configuration Tile is used to create a list of RF Generator and/or Receiver frequencies which can be used to pre-fill the Generator and/or Receiver frequency using the Frequency List Test Tile.

A frequency list can be created using the Frequency List Setup Configuration Tile or a list can be created externally in spreadsheet format and imported to the Test Set.

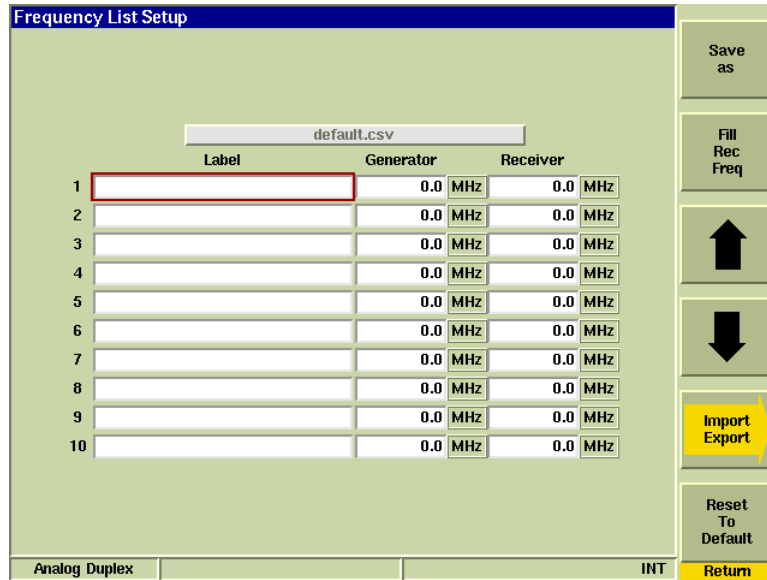

Fig. 7-7 Frequency List Setup Configuration Tile

7.4.5.A Field/Soft Key Definitions

7.4.5.A.1 File Name

Indicates the name of the file in which the frequency list is stored.

7.4.5.A.2 Label

This field is used to identify the frequency Pair. For example the frequency can be labeled for the radio channel it applies to (i.e., Channel 1).

7.4.5.A.3 Gen Frequency

This field is used to define the RF Generator frequency.

7.4.5.A.4 Rec Frequency

This field is used to define the RF Analyzer frequency.

7.4.5.A.5 Save As Soft Key

The Save As Soft Key is used to save a defined frequency list to the Test Set's internal database.

7.4.5.A.6 Fill Rec Freq Soft Key

The Fill Rec Soft Key auto-fills the Receive Frequency field to match the frequency defined in the selected Generator frequency field.

7.4.5.A.7 Up/Down Arrow Soft Key

The Up/Down arrows are used to navigate through the frequency list.

7.4.5.A.8 Import/Export Soft Key

Pressing the Import/Export Soft Key opens a soft key submenu with functions that allow a user to transfer frequency list files to and from the Test Set’s internal database.

NOTE When files are imported/exported, any files with the same name are over-written in the destination directory.

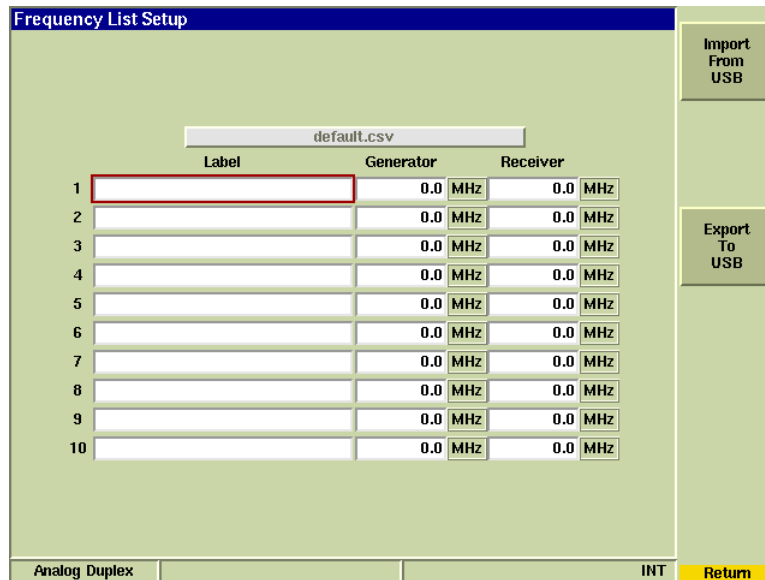

Fig. 7-8 Frequency List - Import/Export Soft Key Submenu

7.4.5.A.9 Import from USB Soft Key

Imports a frequency list file from an external USB device. Files are stored automatically in the Frequency Lists:// directory.

7.4.5.A.10 Export to USB Soft Key

Transfers a frequency list file from the Test Set’s internal database to an external USB device.

7.4.5.A.11 Reset to Default Soft Key

Resets all fields on the Frequency List Setup Configuration Tile to default values.

7.4.5.B How to Export a Frequency List

To export a .csv frequency list file from the Test Set to a USB memory device:

STEP	PROCEDURE
1.	Connect the USB memory device to one of the Test Set’s USB connectors.
2.	Open the Frequency List Setup Configuration Tile.
3.	Press the Import/Export Soft Key.
4.	Press the Export to USB Soft Key.
5.	The Test Set creates a /Instrument/freqlist/ directory on the USB memory device and copies ALL .csv files in the Test Set’s internal database to the directory on the USB memory device.

7.4.5.C How to Import a Frequency List

A frequency list table can be created in a computer environment and imported to the Test Set. Externally generated frequency list files must be in .csv format.

To import a .csv frequency list file:

STEP	PROCEDURE
1.	Place the .csv file(s) to be imported to the Test Set on a USB memory device.
2.	Connect the USB memory device to one of the Test Set's USB connectors.
3.	Open the Frequency List Setup Configuration Tile.
4.	Press the Import/Export Soft Key.
5.	Press the Import from USB Soft Key.
6.	The Test Set copies ALL .csv files on the USB memory device to the Test Set's internal database.

7.4.5.D Frequency List Management

A frequency list file can be created, modified and saved using the Test Set's Frequency List Setup Configuration Tile. A frequency list file can also be managed using standard spreadsheet software.

7.4.5.D.1 Create a Frequency List Using Frequency List Setup Configuration Tile

A frequency list created using the Frequency List Setup Configuration Tile is stored in the Test Set's internal database as a .csv (Comma Separated Values) file. A stored frequency list .csv file(s) can be exported from the Test Set to an external USB memory device. An exported frequency list .csv file(s) can be imported into a standard spreadsheet for editing and/or imported into other 3900 Test Set's (refer to [7.4.5.C, How to Import a Frequency List](#) and [7.4.5.B, How to Export a Frequency List](#)).

To create a frequency list using the Frequency List Setup Configuration Tile:

STEP	PROCEDURE
1.	Open the Frequency List Setup Configuration Tile.
2.	Configure the frequencies to be included in the file. Fig. 7-9 shows an example with five RF Generator and Receiver frequency pairs.

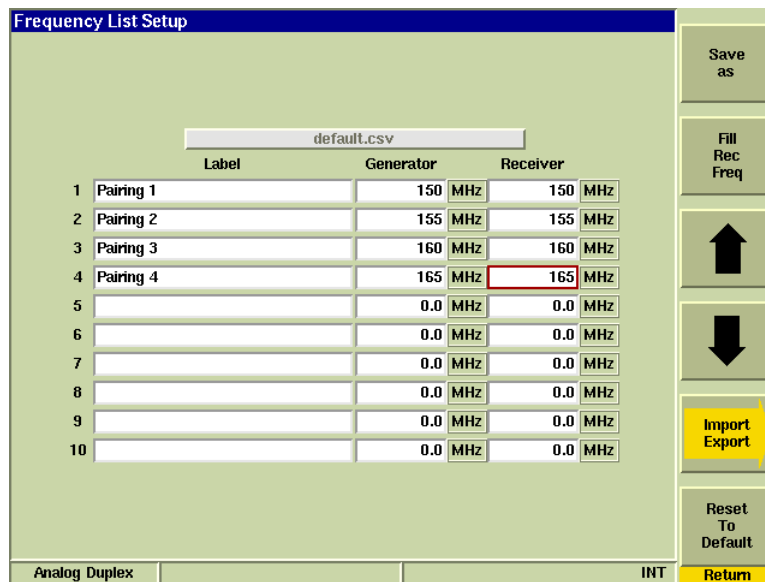

Fig. 7-9 Frequency List - Configure List

3. Press the Save As Soft Key to open the Store dialog window.

STEP

PROCEDURE

- Define the File name under which the defined frequency list is to be stored and press the OK Button.

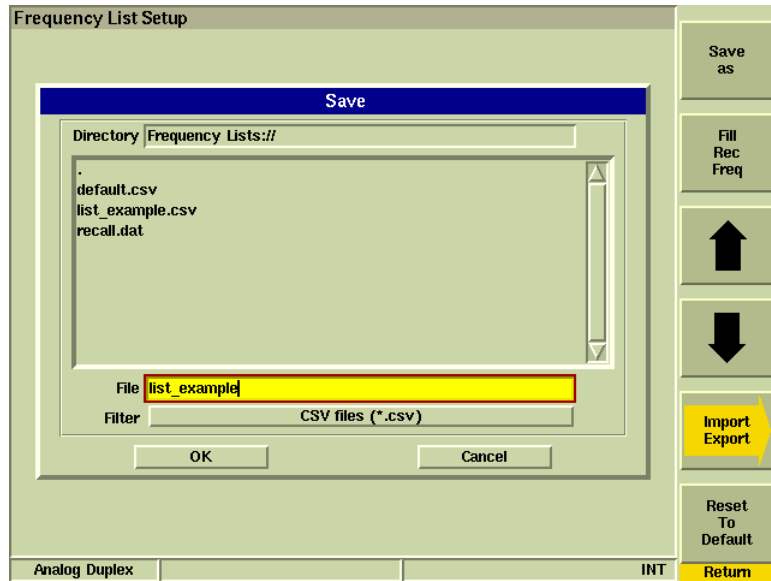

Fig. 7-10 Frequency List - Store File Dialog Window

- The Frequency List Setup Configuration Tile updates to show the file name and the configured frequency list.

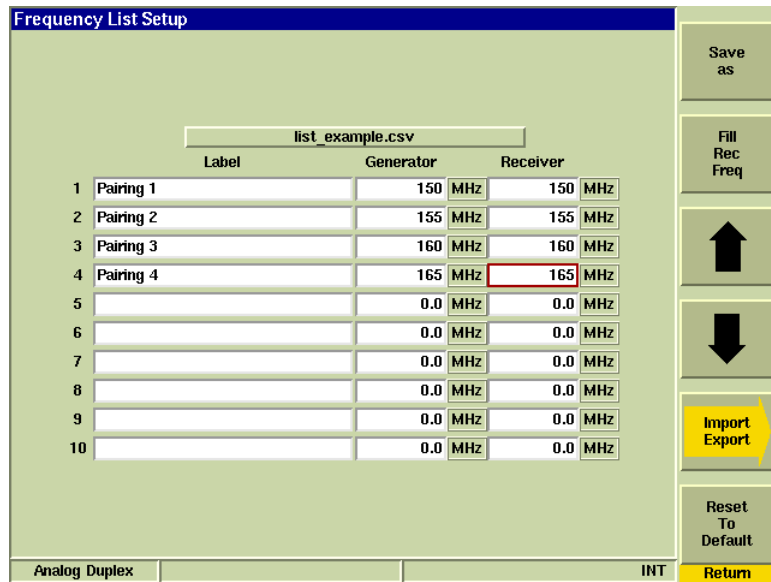

Fig. 7-11 Frequency List - Store File Dialog Window

6. The stored frequency list file can now be selected on the Frequency List Test Tile.

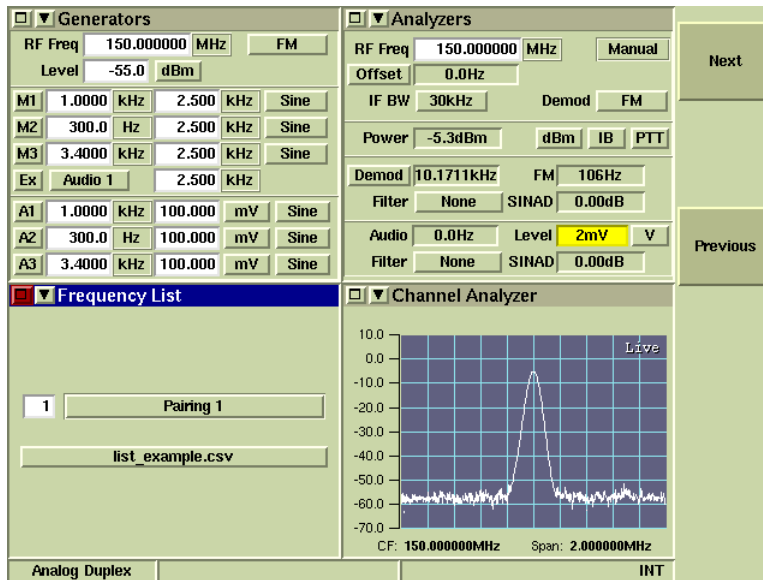

Fig. 7-12 Frequency List - Stored File Available

7.4.5.D.2 Create a Frequency List in Spreadsheet Software

A frequency list can be created as a spreadsheet then imported into the Test Set (refer to [7.4.5.C, How to Import a Frequency List](#)).

A frequency list created externally as a spreadsheet must adhere to the following requirements:

- The file must contain 3 columns;
- The first column must identify the frequency label (max 28 characters);
- The second column must contain the generator frequency in MHz.
- The third column must contain the receiver frequency in MHz.
- The file can contain up to 100 pairs of frequencies configured in row format.
- Files must be stored as a .csv file.

Frequency Pair 1	150	150
Frequency Pair 2	155	155
Frequency Pair 3	160	160
Frequency Pair 4	165	165
Frequency Pair 5	170	170

Fig. 7-13 Frequency List - Format Example

7.4.5.D.3 Modify a Frequency List Using Frequency List Setup Configuration Tile

To modify a frequency list .csv file using the Test Set's Frequency List Setup Configuration Tile:

STEP	PROCEDURE
1.	Open the Frequency List Setup Configuration Tile.
2.	Select the file to be edited from the file drop-down menu.
3.	Make the desired changes to the frequency list file.
4.	Press the Save As Soft Key to open the Store dialog window.
5.	Enter the frequency list file name (keeping same name over-writes current file).
6.	Press the OK Button to save the file.

7.4.5.D.4 Modify a Frequency List Using Spreadsheet Software

NOTE	If the frequency list file was created using the Test Set's Frequency List Setup Configuration Tile, export the file from the Test Set to a USB memory device (refer to 7.4.5.B, How to Export a Frequency List).
-------------	--

To modify a frequency list .csv file in spreadsheet format:

STEP	PROCEDURE
1.	Open frequency list .csv file using spreadsheet software.
2.	Make the desired changes to the frequency list file.
3.	Save the file as a .csv file.
4.	Import the modified frequency list .csv file into the Test Set (refer to 7.4.5.B, How to Export a Frequency List).

7.4.6 Harmonics and Spurious Configuration Tile

The Harmonics and Spurious Configuration Tile sets sweep and Pass/Fail parameters for harmonics and spurious measurements. This tile is only available when the Harmonics & Spurious Test Option (390XOPT060) is installed in the Test Set.

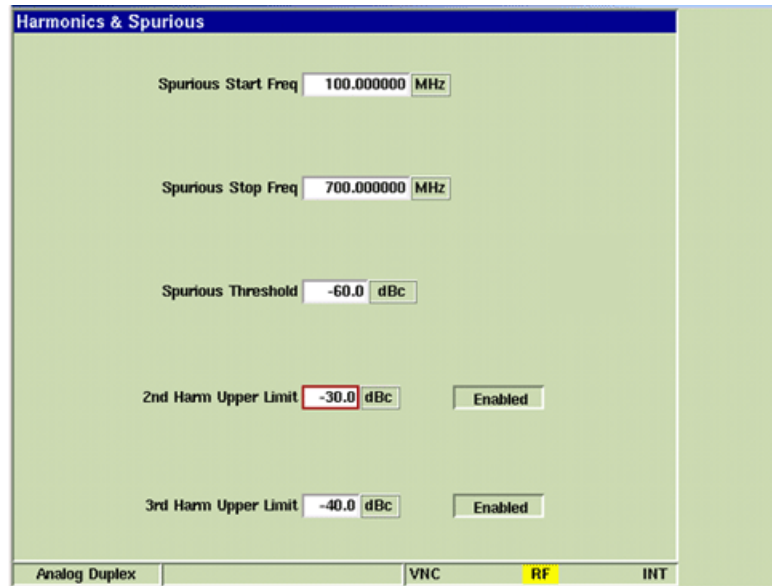

Fig. 7-14 Harm & Spur Limits Configuration Tile

7.4.6.A Field Definitions

7.4.6.A.1 Spurious Start Freq

The Spurious Start field sets the lower frequency at which Spurious measurement sweeps begin.

7.4.6.A.2 Spurious Stop Freq

The Spurious Stop field sets the upper frequency at which Spurious measurement sweeps stop.

7.4.6.A.3 Spurious Threshold Level

The Spurious Threshold field sets the level at which Spurious measurements are triggered. The Test Set records measurements of frequency spikes that exceed the defined threshold level.

7.4.6.A.4 2nd Harmonic Upper Limit

The 2nd Harmonic Upper Limits field sets upper limit value for 2nd Harmonic measurements.

7.4.6.A.5 3rd Harmonic Upper Limit

The 3rd Harmonic Upper Limit field sets upper limit value for 3rd Harmonic measurements.

7.4.6.A.6 Enabled/Disabled

The Enable/Disable Toggle button turns defined limits on and off. Default values are applied if values are not defined by user.

7.4.7 Modulation Limits Configuration Tile

The Mod Limits Configuration Tile sets Pass/Fail limit parameters for RF Measurements. Refer to section titled Limits in Chapter 3 for information on defining limits.

Parameter	Value	Unit	Status
FM RMS Upper Limit	26.000	kHz	Disabled
Lower Limit	0.000	kHz	Disabled
FM Deviation Upper Limit	100.000	kHz	Disabled
Lower Limit	0.000	kHz	Disabled
FM dBr RMS Upper Limit	26.0	dBr	Disabled
Lower Limit	0.0	dBr	Disabled
FM dBr Deviation Upper Limit	26.0	dBr	Disabled
Lower Limit	0.0	dBr	Disabled
AM Depth Upper Limit	99.0	%	Disabled
Lower Limit	0.0	%	Disabled
AM dBr Deviation Upper Limit	26.0	dBr	Disabled
Lower Limit	0.0	dBr	Disabled

Navigation: Analog Duplex | RF | INT | Return

Fig. 7-15 Analog Duplex - Mod Limits Configuration Tile

7.4.7.A Field Definitions

7.4.7.A.1 FM RMS Upper & Lower Limits

The FM RMS Upper and Lower limit fields set limit values for FM RMS measurements.

7.4.7.A.2 FM Deviation Upper & Lower Limits

The FM Deviation Upper and Lower limit fields set limit values for FM Deviation measurements.

7.4.7.A.3 FM dBr RMS Upper & Lower Limits

The FM dBr RMS Upper and Lower limit fields set limit values for FM dBr RMS measurements.

7.4.7.A.4 FM dBr Deviation Upper & Lower Limits

The FM dBr Deviation Upper and Lower limit fields set limit values for FM dBr Deviation measurements.

7.4.7.A.5 AM Depth Upper & Lower Limits

The AM Depth Upper and Lower limit fields set limit values for AM Depth measurements.

7.4.7.A.6 AM dBr Deviation Upper & Lower Limits

The AM dBr Deviation Upper and Lower limit fields set limit values for AM dBr Deviation measurements.

7.4.7.A.7 Enabled/Disabled Toggle Button

The Enable/Disable Toggle button turns defined limits on and off. Default values are applied if values are not defined by user.

7.4.8 Modulation Measurements Configuration Tile

The adjacent Averages entry field enters the number of readings to be averaged for the ANT Inband Power measurement for this reading.

The screenshot shows the 'Mod Measurements' configuration tile. It features several sections:

- FM Demod Meas:** Set to 'Peak'.
- FM Meter Type:** Set to 'PK +/-'.
- FM Offset Compensation:** Set to 'Enabled'.
- Hum & Noise Ref Level:** Set to '12.00 dB'.
- Averages:** A list of measurement types with a value of '1' for each: FM, AM, Frequency, Distortion, SINAD, SNR, and Hum & Noise.
- Hum & Noise/Notch Filter:** Mode is 'Disabled', Frequency is '300 Hz', and Width is '82.0 Hz*'. There is also a 'Set All Averages To' button.
- SINAD/Distortion:** Frequency Lock is 'Unlocked', Frequency is '1.000 kHz', and Width is '82.0 Hz*'. There is also a 'Loudspeaker' set to 'Off' and a '300 Hz HP Filter' set to 'STD Low-Q'.
- Output Port(FCTN GEN/DEMOM) Use:** Set to 'Function Generator'.
- Filter:** Set to 'None'.
- Psoph Filter:** Set to 'CMESS'.

At the bottom of the tile, there are navigation buttons: 'Analog Duplex', 'RF', 'INT', and 'Return'.

Fig. 7-16 Analog Duplex - Modulations Measurements Configuration Tile

7.4.8.A Field/Soft Key Definitions

7.4.8.A.1 FM Demod Meas

Sets the FM Demodulation measurement that reads the RMS or Peak value. The selected option is shown beside the FM Deviation Level field on the Analyzers Tile.

7.4.8.A.2 FM Meter Type

This menu defines the type of bar graph displayed on the FM Deviation meter.

Selecting PK +/- displays a divided bar graph on the FM Deviation meter. The top bar displays the highest FM Deviation measurement. The bottom bar displays the lowest FM Deviation measurement.

Selecting PK/2 displays a single bar graph which displays the average FM Deviation measurement.

7.4.8.A.3 FM Offset Compensation

Enabling FM Offset Compensation removes any frequency offset that is reflected on the FM Deviation Meter bar graph and FM Deviation measurement.

7.4.8.A.4 Hum & Noise Reference Level

Sets Reference Level for Hum & Noise measurements.

7.4.8.A.5 Filter

Selects type of filter to be included in the signal path.

7.4.8.A.6 Psoph Filter

Psoph Filter menu selects whether the CMESS or the CCITT Psophometric weighting filter are used when the Psoph filter is selected from any of the Filter selection drop-down menus. Psoph filters are typically used for SINAD measurements, either Demod or Audio.

7.4.8.A.7 300 Hz Filter Type

Selects type of 300 Hz filter to be included in the signal path.

- Standard: Highpass 300 Hz Low-Q Filter
- Sharp: Highpass 300 Hz high-Q Filter

7.4.8.A.8 Loudspeaker

The Loudspeaker drop-down menu selects the source and routing of the signal applied to the loudspeaker within the Test Set.

7.4.8.A.9 Output Port (FCTN GEN/DEMODO) Use

Selects the output connector on the front panel. Demod options select the FCTN GEN/ DEMOD Connector as the Demodulation Output. When a filtered output option is selected, the filter type is selected from the Psoph filter drop-down menu.

NOTE

Changing configuration to Demod Out while still connected to the MIC/AF input of a radio under test may create a feedback loop.

7.4.8.A.10 Measurement Averages

The number of measurements taken to calculate the average values can be set individually using the Measurement Averages fields. Valid range values are from 1 to 250.

7.4.8.A.11 Hum & Noise/SNR Notch Filter Mode

Selects whether or not a notch filter is used for performing Hum and Noise/ SNR Measurements. When Hum and Noise/ SNR Notch Filter Mode is enabled the notch filter removes the sub audible CTCSS or CDCSS tone.

7.4.8.A.12 Hum & Noise/SNR Notch Filter Frequency

This field defines the frequency that is “notched out” when performing Hum and Noise/ SNR Measurements.

7.4.8.A.13 Hum & Noise/SNR Notch Filter Width

This field sets the Notch Filter Bandwidth used when performing Hum and Noise/ SNR Measurements.

7.4.8.A.14 SINAD/Distn Frequency

Sets frequency at which SINAD or Distortion is measured.

7.4.8.A.15 SINAD/Distn Width

Sets Bandwidth for SINAD and Distortion measurements.

7.4.8.A.16 SINAD/Distn Frequency Mode

When Unlocked mode is selected the frequency at which SINAD or Distortion is measured is defined by the SINAD/Distn Frequency Field. When Locked to A1 is selected, the frequency at which SINAD or Distortion is measured is locked to the AF Generator 1 Frequency field on the Generators Tile.

7.4.8.A.17 Set All Averages To Soft Key

Opens a soft key sub-menu that selects the number used to calculate all RF Measurement averages.

7.4.9 Mod Noise Limits

The Mod Noise Limits Configuration Tile sets Pass/Fail limit parameters for RF Noise Measurements. Refer to section titled Limits in Chapter 3 for information on defining limits.

Parameter	Value	Unit	Status
Distortion Upper Limit	5.0	%	Disabled
SINAD Lower Limit	26.0	dB	Disabled
SNR Upper Limit	0.0	dB	Disabled
Lower Limit	0.0	dB	Disabled
Hum & Noise Upper Limit	10.0	dBr	Disabled
Lower Limit	0.0	dBr	Disabled
Demod Freq Upper Limit	10.000	kHz	Disabled
Lower Limit	0	Hz	Disabled

Navigation buttons: Analog Duplex, RF, INT, Return

Fig. 7-17 Mod Noise Limits Configuration Tile

7.4.9.A Field Definitions

7.4.9.A.1 Distortion Upper Limit

The Distortion Upper limit field sets limit value for Distortion measurements.

7.4.9.A.2 Sinad Lower Limit

The SINAD Lower limit field sets limit value for SINAD measurements.

7.4.9.A.3 SNR Upper & Lower Limits

The SNR Upper and Lower limit fields set limit values for SNR measurements.

7.4.9.A.4 Hum & Noise Upper & Lower Limits

The Hum & Noise Upper and Lower limit fields set limit values for Hum & Noise measurements.

7.4.9.A.5 Demod Freq Upper & Lower Limit

The Demod Freq Upper and Lower limit fields set limit values for Demod measurements.

7.4.9.A.6 Enabled/Disabled Toggle Button

The Enable/Disable Toggle button turns defined limits on and off. Default values are applied if values are not defined by user.

7.4.10 Offsets Configuration Tile

The Offsets Tile contains fields that define offset values for the level and frequency offsets for the RF Generator.

Fig. 7-18 Offsets Configuration Tile

7.4.10.A Field/Soft Key Definitions

7.4.10.A.1 RF Generator Level Offset

The RF Generator Level Offset parameter accounts for a loss or gain to be inserted into the RF path between the 3900 generator output connector (GEN (Generator) Connector or T/R Connector) and the device under test.

The Offset value is indicated in +dB for positive (gain) values. When a positive value is entered, Ext Gain is displayed to the right of the RF Generator Level Offset value field.

The Offset value is indicated in -dB for negative (loss) values. When a negative value is entered, Ext Loss is displayed to the right of the RF Generator Level Offset value field.

When an offset is enabled, an offset indicator appears beside the output level entry field on the Generator Tile.

NOTE

Level Offsets set in the Analog Duplex system are independent of any Level Offsets set in any other System on the Test Set.

7.4.10.A.2 RF Analyzers Level Offset

The RF Analyzer Level Offset accounts for a loss or gain to be inserted into the RF path between the 3900 receiver input Connector (ANT (Antenna) Connector or T/R Connector). The Offset value is indicated in +dB for positive (gain) values. When a positive value is entered, Ext Gain is displayed to the right of the RF Analyzers Level Offset value field. The Offset value is indicated in -dB for negative (loss) values. When a negative value is entered, Ext Loss is displayed to the right of the RF Analyzers Level Offset value field.

NOTE

When an offset is enabled, an offset indicator appears beside the power field on the Analyzers Tile and in the upper left hand corner of the Channel Analyzer Tile.

7.4.10.A.3 Dx Frequency Offset

Dx Frequency Offset allows the frequency spacing between the RF Generator and the RF Analyzer to be set. A positive value sets the RF Generator to a higher frequency than the RF Analyzer setting. Value specified in MHz, kHz or Hz as defined by user.

NOTE

When an offset is enabled, an offset indicator appears beside the output level entry field on the Generators Tile.

7.4.10.A.4 RF Gen Offset Mode

RF Gen Offset Mode Locks or Unlocks the frequency spacing between the RF Generator setting and the RF Analyzer setting. With the setting set to Lock the RF Generator frequency follows any change to the RF Analyzer setting with a spacing equal to the Dx Frequency Offset value.

7.4.10.A.5 AF Generator Attenuation

The AF Generator Attenuation drop-down menu allows the user to apply an offset that compensates for a user supplied external attenuation connected to the FCTN/GEN Demod Out Connector.

7.4.10.A.6 Gen Offset Soft Key

The Gen Offset Soft Key controls the use of the RF Generator Level Offset value. ON inserts the defined RF Generator Level Offset into the RF Path between the selected 3900 generator output connector and the device under test. OFF removes the defined RF Generator Level Offset from the RF Path between the selected 3900 generator output connector and the device under test.

7.4.10.A.7 Ana Offset Soft Key

The Ana Offset Soft Key controls the use of the RF Analyzers Level Offset value. ON inserts the defined RF Analyzers Level Offset into the RF Path between the selected 3900 receiver input connector and the device under test. OFF removes the defined RF Analyzers Level Offset from the RF Path between the selected 3900 receiver input connector and the device under test.

7.4.11 Offsets Cable Loss Measurements

The Cable Loss Measurements functionality provides users with the ability to use the Test Set's Tracking Generator to evaluate a test cable in order to compensate for any cable loss and to characterize attenuators and other devices which impart a gain or loss.

NOTE Cable Loss Measurements are enabled when the 3900 Tracking Generator Option is installed in the Test Set.

7.4.11.A Field/Soft Key Definitions

7.4.11.A.1 Cable Loss File Menu

The Cable Loss File Menu is enabled when the Tracking Generator Option is installed in the Test Set. This menu loads a stored Cable Loss trace file which contains data that defines the RF Generator or RF Analyzer Level Offset by the offset value in the Cable Loss Trace.

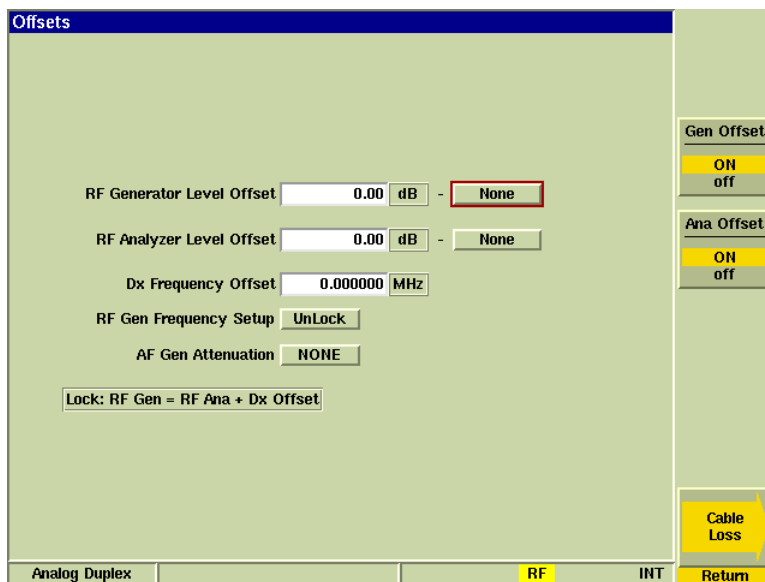

Fig. 7-19 Cable Loss Parameters Enabled

NOTE The Cable Loss File Menu is only populated when one or more Cable Loss traces has been created.

7.4.11.A.2 Cable Loss Soft Key

The Cable Loss Soft Key is enabled when the Tracking Generator Option is installed in the Test Set. The Cable Loss Soft Key accesses soft keys which are used to create tables of amplitude loss for up to three test cables of different configurations.

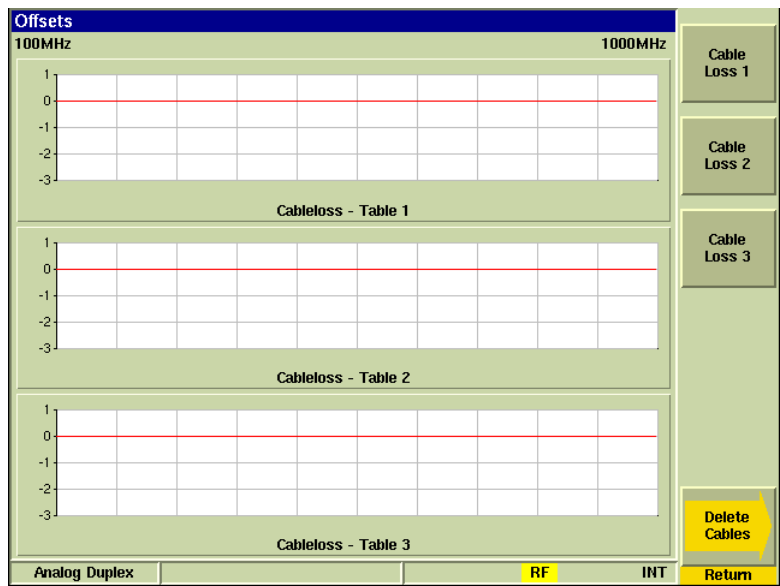

Fig. 7-20 Cable Loss Tables

Pressing the Cable Loss 1, 2 or 3 Soft Key initiates a guided procedure for defining a cable loss table. The Test Set provides a series of on-screen instructions that the user follows to create each table.

NOTE	<p>Cable Loss files are stored in the Test Set's Cable Loss Files directory.</p> <p>Stored Cable Loss Files can be transferred from one Test Set to another using the File Management Tile. The receiving Test Set must have the Tracking Generator Option installed in order to transfer the files.</p> <p>Transferred files must be placed in the receiving Test Set's Cable Loss Files directory in order for the file to be accessible.</p>
-------------	---

7.4.12 Ports Configuration Tile

The Ports Configuration Tile defines the Test Set's output parameters.

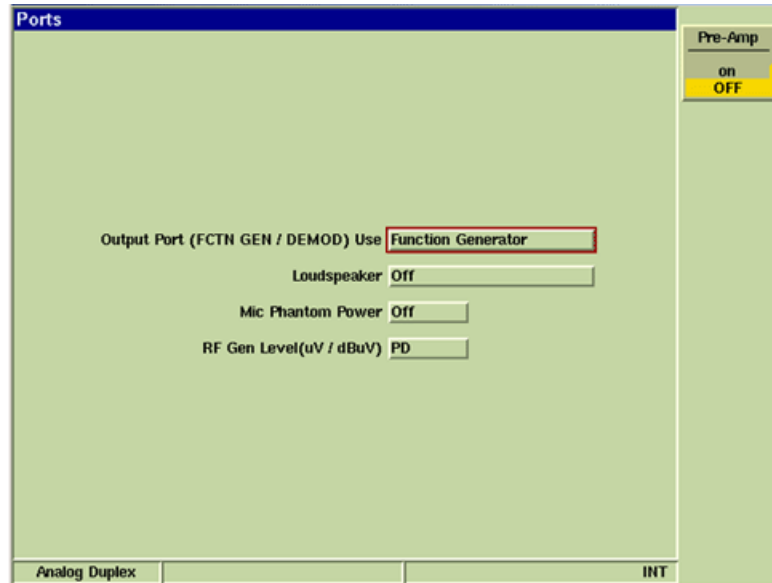

Fig. 7-21 Ports Configuration Tile

7.4.12.A Field/Soft Key Definitions

7.4.12.A.1 Output Port (FCTN GEN/DEMODO) Use

Selects the output connector on the front panel. Demod options select the FCTN GEN/ DEMOD Connector as the Demodulation Output. When a filtered output option is selected, the filter type is selected from the Psoph filter drop-down menu on the AF Measurements Configuration Tile or Modulation Measurements Configuration Tile. Audio In options select the FCTN GEN/DEMODO Connector as the AF Generator output.

NOTE

Changing configuration to Demod Out while still connected to the MIC/AF Input of a radio under test may create a feedback loop.

7.4.12.A.2 Loudspeaker

Selects the signal sent to the internal loud speaker.

7.4.12.A.3 MIC Phantom Power

The MIC/ACC Connector provides a power source for condenser microphones. The Mic Phantom Power drop-down menu turns the power source for the condenser microphone On or Off.

7.4.12.A.4 RF Gen Level

The RF output Level can be displayed as EMF or PD. The selected term is shown adjacent to the Level value.

7.4.12.A.5 Pre-Amp Soft Key

The 3900 is equipped with an internal 15 dB broadband amplifier that affects the T/R and ANT Input Ports. When Pre-Amp is ON, the 3900 has a typical noise figure of -9 dB, resulting in a noise floor level around -140 dBm in the spectrum analyzer (RBW = 300 Hz) and around -126 dBm for the Inband power meter (IF = 6.25 kHz). Use of the Pre-Amp feature dramatically increases the sensitivity of the 3900.

NOTE	When Pre-Amp is used, special attention is required; it is a broadband amplifier and could lead to saturation or compression problems in the receiver chain if the signal of interest is very low, but a strong out of band signal is present.
-------------	--

7.4.13 RF Generator Configuration Tile

The RF Generator Tile contains fields that define RF Generator operational parameters.

The image shows a software configuration window titled "RF Gen". It contains five control elements: a text input field for "Gen Freq Increment" with the value "1" and a unit "Hz"; a text input field for "Gen Level Increment" with the value "0.1" and a unit "dB"; a dropdown menu for "PTT Controls RF Out" set to "OFF"; a dropdown menu for "PTT Polarity Active" set to "Low"; and a dropdown menu for "RF Level(uV / dBuV)" set to "PD". At the bottom of the window, there are two tabs labeled "Analog Duplex" and "INT".

Fig. 7-22 RF Generator Configuration Tile

7.4.13.A Field Definitions

7.4.13.A.1 Gen Frequency Increment

The Gen Freq Increment field sets the value the RF Output Frequency changes each time the INC Gen Freq/DEC Gen Freq Soft Keys are pressed. The INC Gen Freq/DEC Gen Freq Soft Keys are located on the Generators Tile, Analyzers Tile and Meters Tile. This soft key is accessed by pressing the INC/DEC Soft Key. Value is specified in MHz, kHz or Hz as defined by user.

7.4.13.A.2 Gen Level Increment

The Gen Level Increment sets the value in dB, that the RF Level changes each time the INC Gen Level/DEC Gen Level Soft Keys are pressed. The INC Gen Level/DEC Gen Level Soft Keys are located on the Generators Tile, Analyzers Tile and Meters Tile. The soft key is accessed by pressing the INC/DEC Soft Key. Value is specified in MHz, kHz or Hz as defined by user.

7.4.13.A.3 PTT Controls RF Out

PTT RF Out Control is only applicable when a microphone is connected to the 3900 MIC/ACC Connector. When ON is selected PTT must be pressed to utilize the RF Output.

7.4.13.A.4 PTT Polarity Active

PTT Polarity is only applicable when a microphone is connected to the 3900 MIC/ACC Connector. High or Low polarity is applied to the signal when PTT is pressed.

7.4.13.A.5 RF Level

The RF Level field selects whether the RF Generator Output Level, when given in mV (micro Volt) is expressed in a PD or EMF reference system.

μV (PD) = micro Volts Potential Difference

Circuit is closed onto a matching load that is equal to the output impedance of the source. The PD reference system includes a voltage 1:2 divider at the load.

μV (EMF) = micro Volts Electromotive Force

Circuit is open, or closed onto an infinite load. The EMF reference system does not contain a voltage divider at the load, resulting in values two times larger than those in the PD reference system. For example, -120 dBm is equal to 0.225 mV (PD) or 0.45 mV (EMF).

7.4.14 RF Limits Configuration Tile

The RF Limits Configuration Tile sets Pass/Fail limit parameters for the RF Analyzer Frequency Offset measurements and the RF Power measurements. Refer to section titled Limits in Chapter 3 for information on defining limits.

Fig. 7-23 RF Limits Configuration Tile

7.4.14.A Field Definitions

7.4.14.A.1 Frequency Offset Upper Limit

The Frequency Offset Upper Limit field sets limit value for Frequency Offset measurements.

7.4.14.A.2 Frequency Offset PPM Upper Limit

The Frequency Offset PPM Upper Limit field sets limit value for Frequency Offset measurements when the Unit of measure is set to PPM (parts per million).

7.4.14.A.3 T/R Broadband Power Upper & Lower Limits

The T/R Broadband Power Upper and Lower limit fields set limit values for T/R Broadband Power measurements. The Units drop-down menu selects the unit of measurement.

7.4.14.A.4 T/R Inband Power Upper & Lower Limits

The T/R Inband Power Upper and Lower limit fields set limit values for T/R Inband Power measurements. The Units drop-down menu selects the unit of measurement.

7.4.14.A.5 ANT Inband Power Upper & Lower Limits

The ANT Inband Power Upper and Lower limit fields set limit values for ANT Inband Power measurements. The Units drop-down menu selects the unit of measurement.

7.4.14.A.6 Enabled/Disabled Toggle Button

The Enable/Disable Toggle button turns defined limits on and off. Default values are applied if values are not defined by user.

7.4.15 RF Measurements Configuration Tile

The RF Measurements Tile defines the parameters used to perform RF Measurements.

Fig. 7-24 RF Measurements Configuration Tile

7.4.15.A Field/Soft Key Definitions

7.4.15.A.1 Frequency Increment

Sets the value the RF Input Frequency changes each time the INC Ana Freq/DEC Ana Freq Soft Keys are pressed. The INC Ana Freq/DEC Ana Freq Soft Keys are accessed from the INC/DEC Soft Key on the Generators Tile, Analyzers Tile and Meters Tile. Value is specified in MHz, kHz or Hz as defined by user.

7.4.15.A.2 AutoTune Threshold

When Autotune is selected the Test Set sets the RF Analyzer frequency to the strongest signal detected at the active RF Input connector. This reading defines an acceptable signal level in dBm's for successful detection on the ANT (Antenna) Connector. Default setting is -100 dBm on the ANT (Antenna) Connector which reflects -60 dBm on the T/R Connector.

7.4.15.A.3 AutoTune Start Freq

Sets the lower frequency at which AutoTune sweeps start.

7.4.15.A.4 AutoTune Stop Freq

Sets the upper frequency at which AutoTune sweeps stop.

7.4.15.A.5 AutoTune Frequency Resolution

AutoTune Frequency Resolution defines the unit of measure a frequency is rounded to when AutoTune is enabled.

For example, if AutoTune Frequency Resolution is set to 1000 Hz, and the 3900 identifies a frequency as 151.625020 MHz, the frequency would be rounded to 151.625000 MHz and Frequency Error meter would be 20 Hz.

7.4.15.A.6 Freq Offset Resolution

Sets the RF Analyzer RF Frequency Measurement resolution. When set to 10 Hz the speed of measurement increases, however, the resolution is of poorer quality.

7.4.15.A.7 Freq Offset Averages

The Freq Offset Averages drop-down menu allows the selection of Averages or Worst Case readings.

When Average is selected, the range value field sets the number of readings averaged for the RF Offset Measurement. This field is not applicable when Worst Case is selected.

When Worst Case is selected from the drop-down menu, the RF Offset Measurement on the Analyzers Tile reflects the reading which most greatly exceeds the defined parameters.

7.4.15.A.8 T/R Broadband Power Units

The T/R Broadband Power Units field selects the unit of measurement for the T/R Broadband Power reading.

The adjacent Averages entry field enters the number of readings to be averaged for the T/R Broadband Power measurement.

7.4.15.A.9 T/R Inband Power Units

The T/R Inband Power Units field selects the unit of measurement for the T/R Inband Power reading.

The adjacent Averages entry field enters the number of readings to be averaged for the T/R Inband Power measurement for this reading.

7.4.15.A.10 ANT Inband Power Units

The Antenna Inband Power Units field selects the unit of measurement for the ANT Inband Power reading.

The adjacent Averages entry field enters the number of readings to be averaged for the ANT Inband Power measurement for this reading.

7.4.15.A.11 Set All Averages To Soft Key

Opens a soft key sub-menu that selects the number used to calculate all RF Measurement averages.

7.4.16 RF Modulation Configuration Tile

The RF Modulation Configuration Tile allows the user to select the external modulation source.

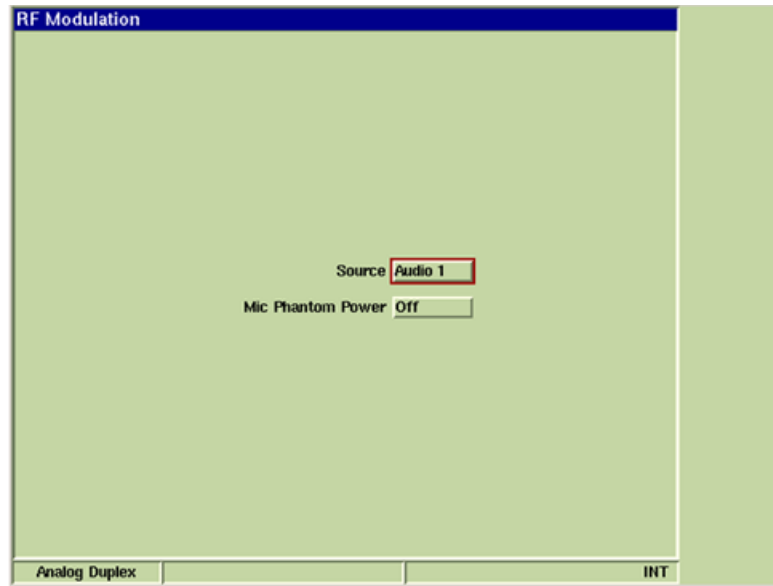

Fig. 7-25 Modulation Generator Configuration Tile

7.4.16.A Field Definitions

7.4.16.A.1 Source

The Source field selects the routing for an external modulation source. A signal applied to the selected Connector serves as a modulation source for the RF Generator when the Ext button is active on the Generators Tile.

7.4.16.A.2 MIC Phantom Power

The MIC/ACC Connector provides a power source for condenser microphones. The Mic Phantom Power drop-down menu turns the power source for the condenser microphone On or Off.

7.4.17 Tone Sequential Configuration Tile

The Tone Sequential Configuration Tile defines parameters of an encoded Tone Sequential signal generated by the Test Set. Additional parameters are defined on the Tone Encoding Tile.

Tone	Frequency	Duration (ms)	Pause (ms)
0	1500 Hz	70	15
1	1550 Hz	70	15
2	1600 Hz	70	15
3	1650 Hz	70	15
4	1700 Hz	70	15
5	1750 Hz	70	15
6	1800 Hz	70	15
7	1850 Hz	70	15
8	1900 Hz	70	15
9	1950 Hz	70	15
A	2000 Hz	70	15
B	2050 Hz	70	15
C	2100 Hz	70	15
D	2150 Hz	70	15
E	2200 Hz	70	15
F	2250 Hz	70	15

Mode: Mod Gen
Protocol: USER1

Analog Duplex RF INT Return

Fig. 7-26 Tone Sequential Configuration Tile

7.4.17.A Field/Soft Key Definitions

7.4.17.A.1 Mode

Selects whether the parameters will be applied to a Modulated or Audio user defined sequence.

7.4.17.A.2 Protocol (Type)

The Protocol Drop-down menu allows the user to create two custom protocol configurations. Selecting USER 1 or USER2 displays a pre-defined tone set which can be modified to create custom protocols. After USER1 and/or USER2 parameters are defined the configurations can be saved and recalled using the Test Set's Store/Recall Function.

7.4.17.A.3 Tone (Sequence)

Indicates the tone number code digit.

7.4.17.A.4 Frequency

Defines the frequency of the tone that corresponds to each tone number code digit.

7.4.17.A.5 Duration

Defines the duration of the tone that corresponds to each tone number code digit.

7.4.17.A.6 Pause

The Pause field defines how long the Modulation (or Audio) pauses before continuing the tone sequence. The "-" key in the tone sequence is used to indicate a pause.

7.5 TEST TILES

7.5.1 Analyzers Tile

The Analyzers Tile interfaces the RF Analyzer, the RF Power Meters, the Modulation Analyzer and the AF Analyzer. Each section of the Analyzers Tile contains parameters that are used for measuring aspects of the RF signals being received from the equipment under test.

7.5.1.A RF Analyzer Field Definitions

The RF section of the Analyzers Tile displays RF measurements as well as parameters to configure RF readings.

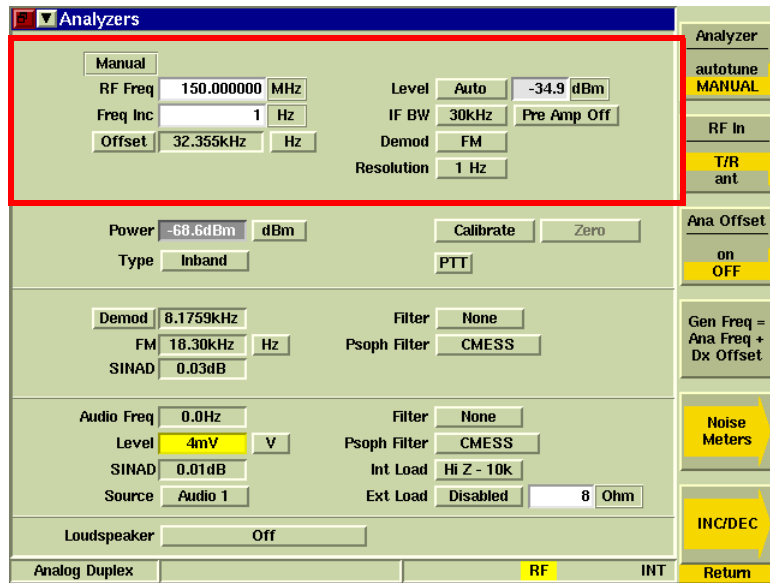

Fig. 7-27 Analyzers Tile - RF Analyzer Fields

7.5.1.A.1 RF Freq

The RF Freq field on the Analyzers Tile defines the frequency of the received signal. For accurate measurements this field must be set to match the Tx Frequency of the unit under test.

The Analyzer frequency is the center or reference frequency for measurements. Units of measure are GHz, MHz, kHz and Hz. Value must be set when Manual tuning is selected. When Autotune is selected on the Analyzer Soft Key, the RF Input Frequency is set by the Analyzer to the strongest received RF signal.

7.5.1.A.2 Freq Inc (Analyzer)

Sets the value applied to the RF Analyzer Input Frequency when the INC Ana Freq/DEC Ana Freq Soft Keys are pressed. Unit of measure for incremented value is defined by user.

7.5.1.A.3 Measurement Mode

Offset Mode

When Offset Mode is selected this field displays the difference between the Test Set's RF Frequency and the RF Input signal.

The Units drop-down menu beside the Offset field selects the unit of measure used to display the Frequency Offset measurement.

Counter Mode

When Counter Mode is selected this field displays the measured frequency of the RF Input signal. The frequency is displayed in the unit of measurement selected for the RF Frequency.

7.5.1.A.4 Level (AGC) Mode

Level defines the AGC Mode of operation. With Auto is selected from the Level drop-down menu, the Automatic Gain Control (AGC) function optimizes the attenuation or gain. With Manual is selected from the Level drop-down menu, the Level setting field must be set a value for the expected level of input signal.

7.5.1.A.5 IF BW

The IF BW field selects the IF Bandwidth Filter included in the demodulation path. AM USB and LSB modulation types are limited to a 4 kHz IF Bandwidth filter.

IF Bandwidth options are:

AM (kHz)	FM (kHz)
6.25	6.25
8.33	10
10	12.5
12.5	25
25	30
30	100
	300

7.5.1.A.6 Pre-Amp

The 3900 is equipped with an internal 15 dB broadband amplifier that affects the T/R Connector and ANT (Antenna) Connector. When Pre-Amp is turned ON, the 3900 has a typical noise figure of -9 dB leading to a noise floor level of approximately -140 dBm in the Spectrum Analyzer (RBW = 300 Hz) and approximately -126 dBm for the Inband Power Meter (IF = 6.25 kHz). Using the Pre-Amp feature increases the sensitivity of the 3900.

NOTE	When Pre-Amp is used, special attention is required; it is a broadband amplifier and could lead to saturation or compression problems in the receiver chain if the signal of interest is very low, but a strong out of band signal is present.
-------------	--

7.5.1.A.7 Modulation

Displays the type of modulation measurement of the signal, either FM Deviation or AM Modulation Depth. The meter field to the right of the Modulation Measurement Type displays the modulation measurement.

7.5.1.A.8 Resolution

Sets the RF Input Signal's frequency resolution setting. Setting options are 1 Hz or 10 Hz.

7.5.1.A.9 Information Flags

Squelch When the Incoming signal is suppressed by the Squelch filter, a Squelch flag indicator appears on the Analyzers Tile. When the tile is minimized, (SQ) is displayed; when the tile is maximized SQUELCH is displayed.

7.5.1.B Power Meter Field Definitions

The Power Meter section of the Analyzers Tile displays power measurements and reading parameters.

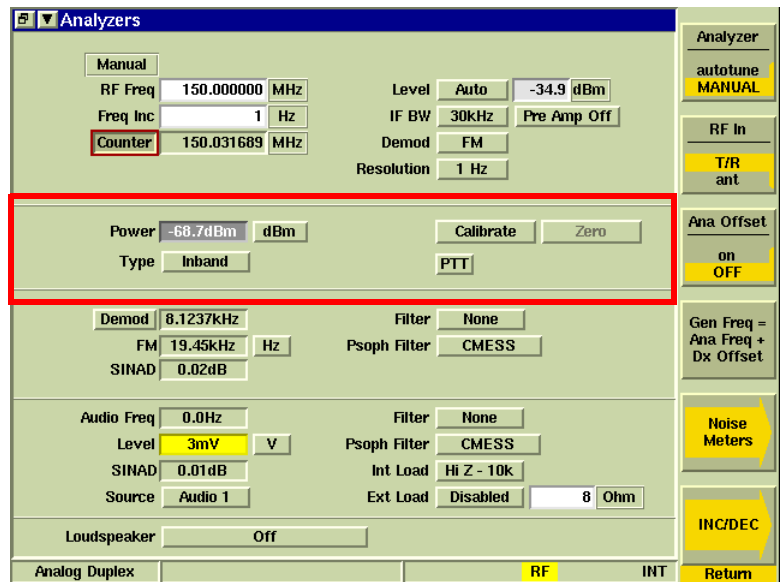

Fig. 7-28 Analyzers Tile - Power Meter Fields

7.5.1.B.1 Power

Indicates the RF Power reading. The broadband power measurement function is only available when the T/R Connector is selected for the RF Input.

7.5.1.B.2 Units

Sets the unit of measurement for the RF Power reading.

7.5.1.B.3 Power Type

This button toggles between Inband and Broadband power measurements. The Inband Power measurement function is available when the ANT (Antenna) Connector or T/R Connector is selected for RF Input. The Broadband/Inband button is only active when the T/R Connector is selected.

7.5.1.B.4 Calibrate

When pressed, the Test Set compensates measurement variations resulting from temperature changes. This function is the same as running the UTILS mode User Calibration procedure. This button is only available when Inband Power measurements are selected.

7.5.1.B.5 Zero

When pressed, the Test Set zeroes out any internal cable loss. This button is only available when Broadband Power measurements are selected.

7.5.1.B.6 PTT

Toggle button enables or disables the Push To Talk Out Control (MIC).

7.5.1.C Modulation Analyzer Field Definitions

The Modulation section of the Analyzers Tile displays modulation measurements as well as parameters to configure modulation readings.

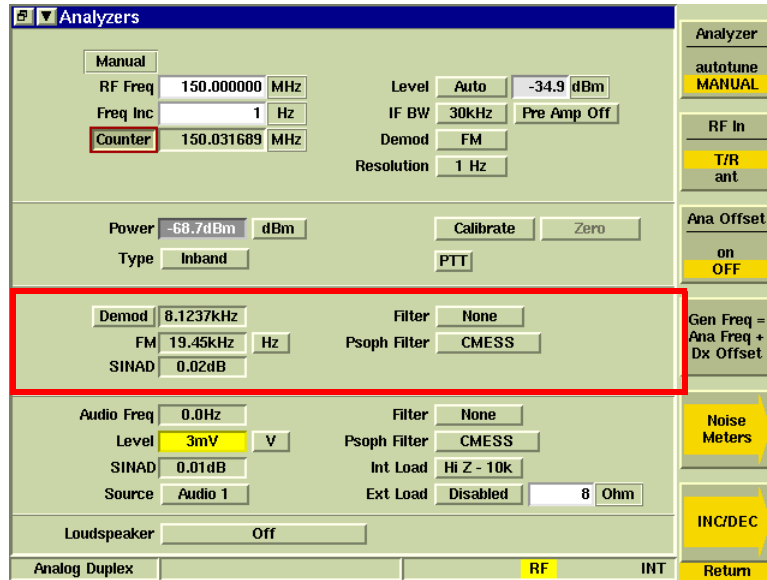

Fig. 7-29 Analyzers Tile - Modulation Fields

7.5.1.C.1 Decode Measurement Type/Meter

The Decode Measurement Type determines how the Test Set processes the received signal.

The Decode Type menu on the Analyzers Tile and the Tone Type menu on the Tone Decode Tile are linked parameters. When DTMF, Two Tone Sequential, Tone Sequential or Tone Remote are selected as the Tone Types on the Tone Decoding Tile, the Demod Code Type on the Analyzers Tile updates to Demod (Off). When either DCS or DCSINV are selected as the Demod Decode Types on the Analyzers Tile the Tone Type on the Tone Decode type updates to OFF.

Demod

When Demod is selected, the field to the right of the drop-down menu displays the averaged frequency of the modulating signal.

DCS/DCSINV

When DCS or DCSINV is selected, the field to the right of the drop-down menu displays the octal DCS value of the received signal.

7.5.1.C.2 Decode Measurement Value

The meter field to the right of the Decode Measurement Type drop-down menu displays the decoded value of the modulating signal.

7.5.1.C.3 Modulation Measurement Type/Meter

Displays the type of modulation measurement of the signal, either FM Deviation or AM Modulation Depth. The meter field to the right of the Modulation Measurement Type displays the modulation measurement.

7.5.1.C.4 Noise Measurement Type/Meter

The Modulation Noise Measurement Type displays the type of noise measurement being performed. The meter field to the right of the label displays the measured noise level on the audio signal, using the modulation applied to the Test Set RF Output Connector as the reference. The desired noise measurement (Distortion, SNR, SINAD or Hum & Noise) is selected from the Noise Meters Soft Key sub-menu.

7.5.1.C.5 Filter

The Filter drop-down menu selects a measurement filter to include in the audio signal measurement path.

NOTE Demod Out sets the FCTN GEN/DEMODO Connector as the Demodulation Output. AF Out sets the FCTN GEN/DEMODO Connector as the AF Generator Output.

7.5.1.D Audio Analyzer Field Definitions

The Audio section of the Analyzers Tile displays audio measurements as well as parameters to configure audio readings obtained from front panel connectors.

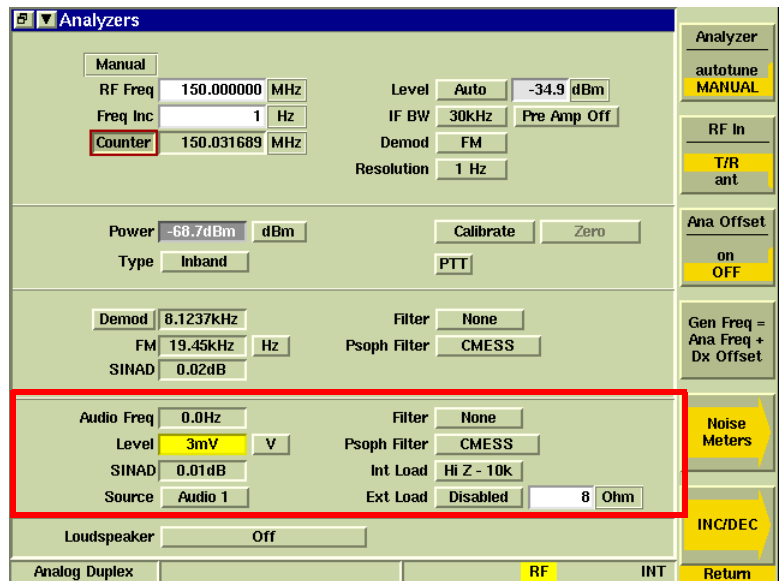

Fig. 7-30 Analyzers Tile - Audio Analyzer Fields

7.5.1.D.1 Audio Freq

Displays the averaged frequency of the Audio input signal.

7.5.1.D.2 Level

Displays the averaged level of the Audio input signal. When V is selected from the Units drop-down menu, a scale indicator is displayed next to the Level reading.

7.5.1.D.3 Noise Measurement Type

Displays the measured noise level on the demodulated signal, using the audio signal applied to the unit under test as the reference. The desired noise measurement (Distortion or SINAD) is selected from the Noise Meters Soft Key sub-menu.

7.5.1.D.4 Filter

The Filter drop-down menu selects a measurement filter to include in the audio signal measurement path.

7.5.1.D.5 Units

Selects the unit of measure for the Level reading. Available value is limited by selected audio input Source. For example, the Balanced audio input Source can be set to either dBm or dBv: V is not available as an option. When V is selected, a scaling value indicator (mV) is displayed beside the Level reading field on the Generators Tile.

7.5.1.D.6 Source

Selects the Audio input source for base band receive measurements and Tone Decoding.

7.5.1.D.7 Int Load

Selects either the 10 kOhm or 600 Ohm internal load to be applied at the Audio 1 or Audio 2 Input. Remote Commands

7.5.1.D.8 External Load

The Ext Load toggle button enables/disables the use of an external load. The 3900 allows the user to define an external load value which is applied at the Audio 1 or Audio 2 Input ports. The external load value is applied to AF Level dBm or Watt measurements when the External Load is enabled.

External Load is disabled when Balanced is selected as the Audio Input Source.

7.5.1.D.9 Loudspeaker

The Loudspeaker drop-down menu selects the source and routing of the demod/audio signal applied to the loudspeaker within the Test Set.

7.5.1.E Soft Key Definitions

7.5.1.E.1 Analyzer Soft Key

The Analyzer Soft Key selects the method of setting the RF input frequency (Autotune or Manual). When Autotune is selected the Test Set locks on to the strongest signal. Once the Test Set locks on to a frequency, it monitors the Inband/Broadband Power Meter depending on the selected RF Input connector.

T/R Connector

When the T/R Connector is selected Autotune monitors the Inband and Broadband Power Meter. If Inband Power drops below the dB threshold defined on the RF Measurements Configuration Tile, and BroadBand Power exceeds 3 dBm, a search is triggered and the Test Set again searches for the strongest signal with a power level above the defined threshold.

ANT Connector

When the ANT Connector is selected Autotune monitors the Inband Power Meter. If Inband Power drops below the dB threshold defined on the RF Measurements Configuration Tile, a search is triggered and the Test Set again searches for the strongest signal with a power level above the defined threshold.

7.5.1.E.2 RF In Soft Key

The RF In Soft Key controls the RF Input signal routing. Select either the T/R Connector or ANT (Antenna) Connector as the RF Input port.

7.5.1.E.3 Ana Offset Soft Key

Applies or removes a level offset value to the analyzer input. With the Offset value ON the input power level readings are adjusted to include the offset value. This value is set on the Offsets Configuration Tile and Analyzers Tile.

7.5.1.E.4 Noise Meters Soft Key

Opens a soft key sub-menu that allows measurement option to be selected to be displayed on the Meters Tile for Modulation Distortion and AF Distortion measurement.

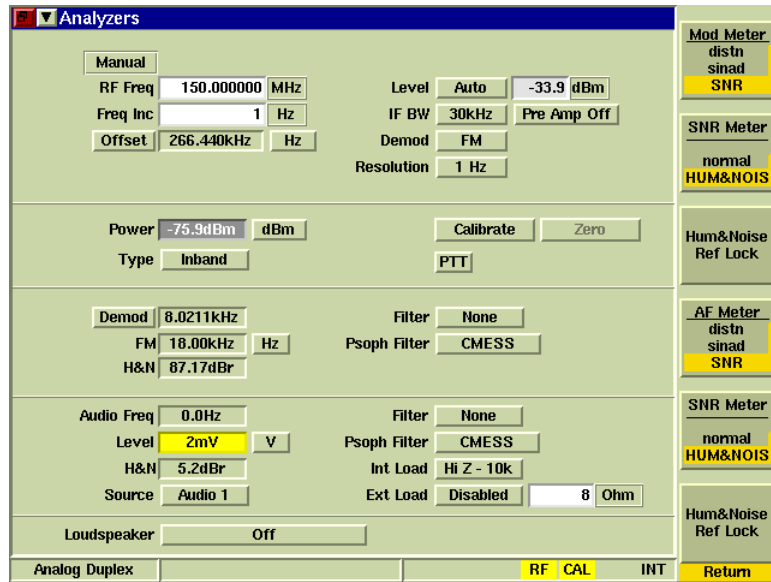

Fig. 7-31 Analyzers Tile - Noise Meters Soft Key Sub-menu

7.5.1.E.5 Mod Meter Soft Key

Selects type of measurement to be displayed in Modulation Meter. Selecting SNR (Signal to Noise Ratio) enables the SNR Meter Soft Key which allows user to select the type of SNR measurement to be performed (Normal SNR or Hum & Noise).

7.5.1.E.6 SNR Meter Soft Key (Mod)

Selects the type of Mod/AF SNR measurement to be performed, either Normal or Hum & Noise. The SNR Meter Soft Keys are only available when SNR is selected on the Mod Meter and/or AF Meter Soft Keys.

Mod SNR Normal

When the Normal Mod SNR Meter is selected, the Test Set transmits an audio signal to a radio under test in an ON/OFF cycle. The internal signal of the radio under test is modulated with the audio signal it receives from the Test Set. The radio under test sends this modulated signal back to the Test Set. The Test Set receives and demodulates the signal received from the radio under test. The ratio of the level of the demod audio signal when the Mod Generator is ON versus the level when the Mod Generator is OFF is the SNR reading.

Mod SNR Hum & Noise

The Mod SNR Hum & Noise reading measures the transmitter of the radio under test. SNR Hum & Noise is a measurement of the level of the audio signal that is demodulated by the Test Set when the radio sends a modulated signal versus when the signal is not modulated.

To use the Mod SNR Meter to obtain Mod Hum & Noise measurements:

STEP	PROCEDURE
1.	Connect the transmitter of the radio under test to the Test Set.
2.	Add modulation at the desired level to the radio under test.
3.	Press the Hum & Noise Ref Lock Soft Key to obtain a reference lock of the demodulated signal received by the Test Set.
4.	Remove the modulation from the radio under test.
5.	The Test Set displays the Mod SNR Hum & Noise measurement relative to the level of the demodulated received signal when the radio under test was being modulated.

7.5.1.E.7 AF Meter Soft Key

Selects the type of AF SNR measurement to be performed, either Normal or Hum & Noise. This soft key is only available when SNR is selected on the AF Meter Soft Key.

7.5.1.E.8 AF SNR Meter Mode Soft Key

Selects the type of AF SNR measurement to be performed, either Normal or Hum & Noise. This soft key is only available when SNR is selected on the AF Meter Soft Key.

AF SNR Normal

When the Normal AF SNR Meter is selected the Test Set transmits a user defined, modulated RF signal to a radio under test. The Test Set transmits the signal, cycling the modulation ON and OFF while the signal is being transmitted. The desired modulated signal must be enabled before the SNR Meter Soft Key is selected. The radio under test demodulates the signal it receives from the Test Set and sends an audio signal back to the Test Set (via the Audio In connectors). The ratio of the level of the audio in the modulated signal versus the level of audio in the demodulated signal is the SNR reading.

AF SNR Hum & Noise

The AF SNR Hum & Noise reading measures the receiver of the radio under test. AF SNR Hum & Noise is a measurement of the level of the audio signal that is demodulated by the radio when the Test Set sends a modulated signal versus when the signal is not modulated.

To use the AF SNR Meter to obtain Hum & Noise measurements:

STEP	PROCEDURE
1.	Connect the transmitter of the Test Set to the radio under test.
2.	Connect the demodulated audio of the radio under test to on of the Test Set's Audio In Connectors.
3.	Add modulation at the desired level to the Test Set.
4.	Press the Hum & Noise Ref Lock Soft Key to obtain a reference lock of the audio in the signal received by the Test Set.
5.	Remove the modulation from the Test Set's transmitted signal.
6.	The Test Set displays the AF SNR Hum & Noise measurement relative to the level of the audio in the signal when the Test Set was being modulated.

7.5.1.E.9 Hum & Noise Ref Lock Soft Key

Sets a reference lock to the current Hum & Noise Meter reading. This soft key is only available when Hum & Noise SNR is selected on the SNR Meter or AF Meter Soft Key.

7.5.1.E.10 Gen Freq = Ana Freq + Dx Offset Soft Key

The Gen Freq = Ana Freq + Dx Offset Soft Key sets the RF Generator frequency to a value spaced from the RF Analyzer frequency as set in the Dx Offset field on the Generators Tile.

7.5.1.E.11 INC/DEC Soft Key

Opens a soft key sub-menu that increments or decrement a specific setting.

7.5.1.E.12 INC Gen Freq/DEC Gen Freq Soft Key

Each press of the soft key causes the RF Generator frequency to increment or decrement by the value set in the Freq Inc field on the Generators Tile.

7.5.1.E.13 INC Gen Level/DEC Gen Level Soft Key

Each press of the soft key causes the RF Generator level to increment or decrement by the value set in the Level Inc field on the Generators Tile.

7.5.1.E.14 INC Ana Freq/DEC Ana Freq Soft Key

Each press of the soft key causes the RF Analyzer frequency to increment or decrement by the value set in the Freq Inc (Analyzer) field on the Analyzers Tile.

7.5.1.E.15 Return Soft Key

Returns to the top level soft key functions for the RF Generators Tile.

7.5.2 Frequency List Test Tile

The Frequency List Tile is used to select a stored frequency list file. When a file is selected the RF Generator and/or Received (Analyzer) frequencies defined in the frequency list file update the frequency fields on the Generator and Analyzer Tiles.

NOTE

Frequency list files are configured and managed using the Frequency List Setup Configuration Tile.

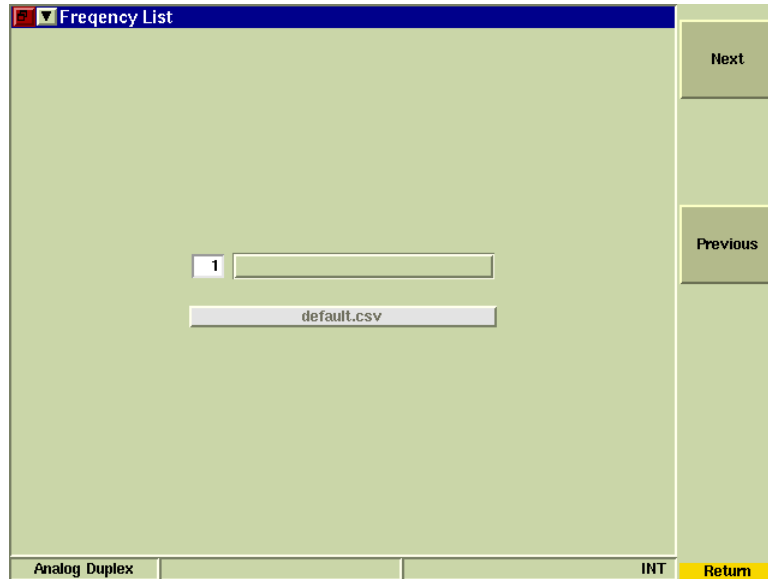

Fig. 7-32 Frequency List Test Tile

7.5.2.A Field/Soft Key Definitions

7.5.2.A.1 File Name

Selects the stored frequency list file to be loaded.

7.5.2.A.2 Next Soft Key

Loads the next frequency defined in the frequency list file.

7.5.2.A.3 Previous Soft Key

Loads the previous frequency defined in the frequency list file.

7.5.3 Generators Tile

The Generators Tile controls the Test Set's RF, AF and Modulated Signal Generators. The user can select either the T/R or GEN (Generator) Connector as the RF Signal Generator output source. The AF Signal Generators, AF1, AF2 and AF3, are combined for output at the FCTN GEN/DEMOD Connector. The RF output can be modulated by the sum of the Modulators, Mod 1 and Mod 2, plus the External input (Audio In or Microphone).

7.5.3.A RF Generator Field Definitions

The RF Generator fields on the Generators Tile are used configure the 3900 RF Signal Generator.

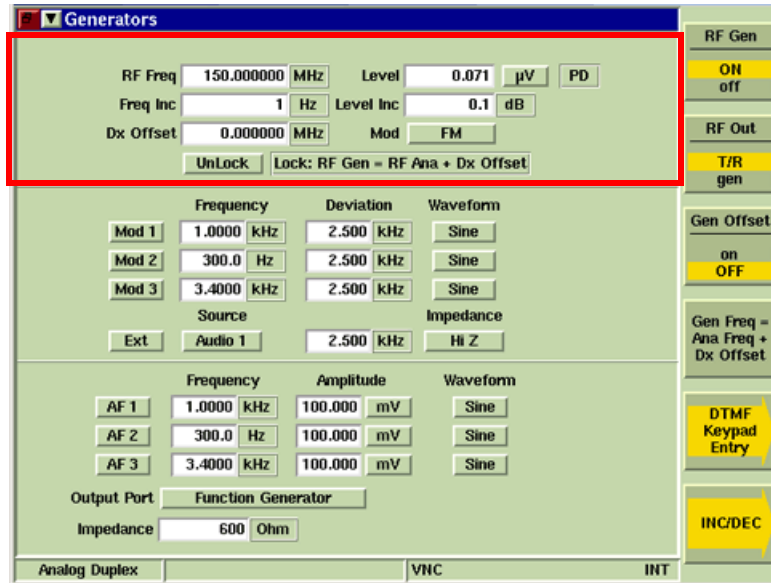

Fig. 7-33 Generators Tile - RF Generator Fields

7.5.3.A.1 RF Freq

The RF Freq field sets the RF Output frequency of the Test Set RF Generator. Units of measure are GHz, MHz, kHz and Hz as defined by user.

7.5.3.A.2 Freq Inc

The Freq Inc field defines the RF Output Frequency incremental change value. This is the value by which the RF Output Frequency is changed when the INC Gen Freq/DEC Gen Freq Soft Keys are used. Units of measure are GHz, MHz, kHz and Hz as defined by user.

7.5.3.A.3 Dx Offset

The Dx Offset field defines the Duplex Offset frequency value. The frequency value set here indicates the difference between the RF Generator output and the RF Analyzer input when the Gen Freq = Ana Freq + Dx Offset Soft Key soft key is active. Units of measure are MHz, kHz and Hz as defined by user.

7.5.3.A.4 Level

The Level field sets the RF Generator Output Level. The selected RF Output level is dependent on the RF Output port selected. The indicated RF output is modified if an RF Level Offset value is set. Units of measure are dBm, V and dBuV.

Refer to Appendix B, 3900 Platform Specifications for output information.

EMF or PD When the RF Output Level unit of measurement is Volts, the value can be displayed as EMF or PD.

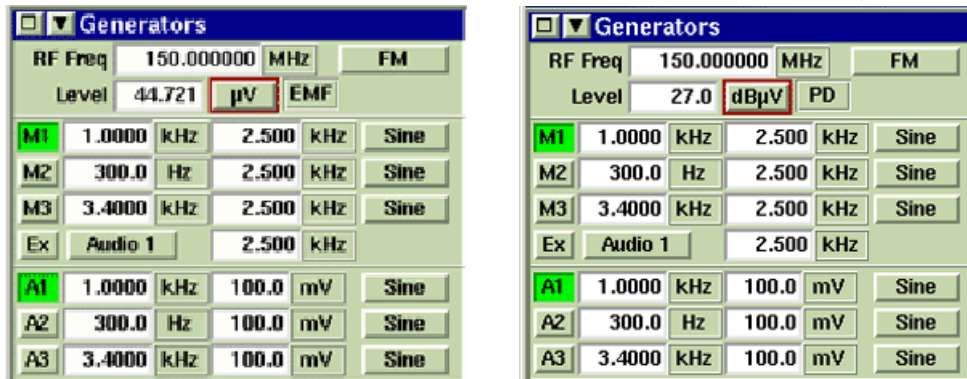

Fig. 7-34 EMF and PD Indicators

7.5.3.A.5 Level Inc

The Level Inc field defines the RF Output Level incremental change value in dB. This value is applied to the RF Output Level when the INC Gen Level/DEC Gen Level Soft Keys are pressed.

7.5.3.A.6 Mod (Modulation)

The Mod (Modulation) menu selects the type of modulation applied to the RF Output Signal.

7.5.3.B Modulation Generators Field Definitions

The 3900 contains three modulation generators which can be applied to the RF Generator in any combination. Each modulation generator is independently controlled by the settings fields in this section of the Generators Tile.

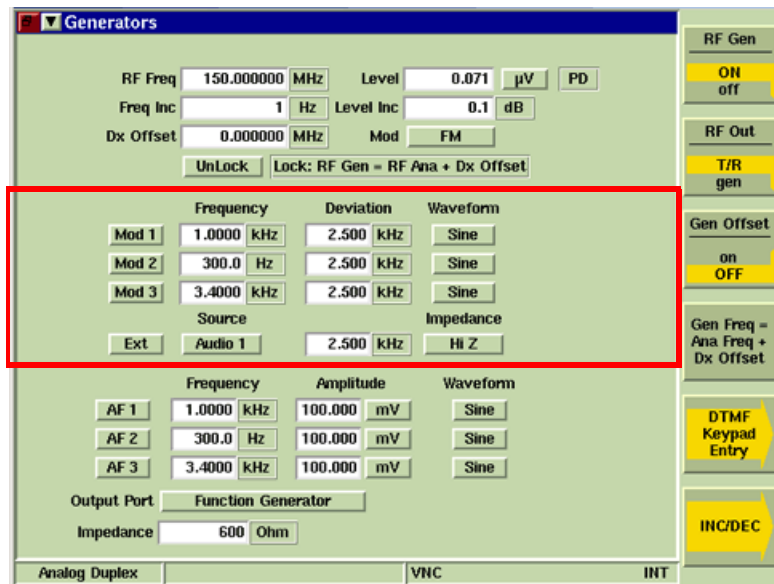

Fig. 7-35 Modulation Generator Fields

7.5.3.B.1 Mod 1, Mod 2, Mod 3

The Modulator toggle buttons enable/disable each modulation generator. Modulation can also be provided from an external source as selected from the MIC Input or the Audio 2 connector on the Modulation Measurements Configuration Tile.

7.5.3.B.2 Frequency

The Frequency field sets the frequency for each Modulation generator. Frequency can be specified in kHz or Hz as defined by user.

7.5.3.B.3 Deviation

Deviation defines the deviation for each generator when FM Modulation is selected. Deviation can be specified in kHz or Hz as defined by user.

7.5.3.B.4 Waveform

The Waveform field defines the Waveform for each generator.

7.5.3.B.5 Sequence

The Sequence field is enabled when DTMF Waveform is selected. The field defines/ indicates the DTMF Sequence of the DTMF Waveform.

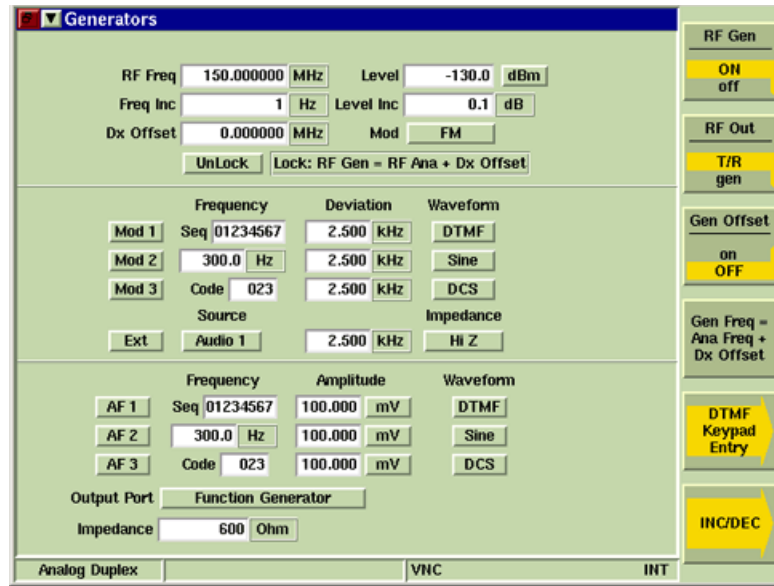

Fig. 7-36 DTMF Waveform Enabled Fields

7.5.3.B.6 CODE

The Code field is enabled when DCS or DCSINV Waveform is selected. The field defines/ indicates the DCS codeword of the generated signal.

7.5.3.B.7 Depth

The Depth field defines the depth for each generator when AM Modulation is selected. Depth is displayed as a percentage.

NOTE A warning indicator is displayed if the sum of the active modulation source level is set to exceed 99% AM or 150 kHz FM.

7.5.3.B.8 External Modulation

The External Modulation toggle button enables/disables the selected external audio source.

7.5.3.B.9 Source

The Source field sets the external modulation source for the Modulation Generators.

7.5.3.B.10 Impedance

The Impedance menu sets External source to un-terminated high impedance (Hi Z), or includes a 600 ohm termination.

7.5.3.C AF Generator Field Definitions

The AF Generator fields on the Generators Tile are used configure the 3900's three Audio Function Generators.

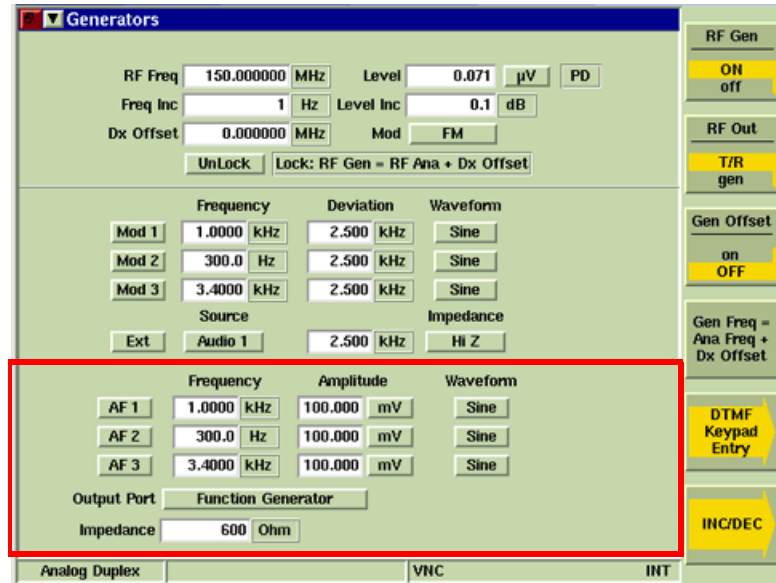

Fig. 7-37 AF Generator Fields

7.5.3.C.1 AF 1, AF 2, AF 3

The AF Generator tick boxes enable/disable the Test Set's AF Generators. The Generators can be enabled in various configurations.

7.5.3.C.2 Frequency

The AF Generator Frequency field sets the frequency for each AF generator. Frequency can be specified in kHz or Hz as defined by user.

7.5.3.C.3 Amplitude

The Amplitude field defines the amplitude for each AF Generator. Deviation can be specified in V or mV as defined by user.

NOTE Output Level Warning is displayed if the sum of the active AF Generator levels is set to exceed 5 V.

7.5.3.C.4 Waveform

The Waveform field defines the Waveform for each AF Generator.

7.5.3.C.5 Output Port

Setting Output Port to AF Out routes the output from the AF Generators to the FCTN GEN/DEMOM Connector. Selecting Demod Out routes a demodulated audio signal to the FCTN/GEN Demod Out Connector.

7.5.3.C.6 Sequence

The Sequence field is enabled when DTMF Waveform is selected. The field defines/ indicates the DTMF Sequence of the DTMF Waveform.

7.5.3.C.7 CODE

The Code field is enabled when DCS or DCSINV Waveform is selected. The field defines/ indicates the DCS codeword of the generated signal.

7.5.3.C.8 Impedance

The AF Impedance field defines the external termination value used to calculate the AF Generator power level.

7.5.3.D Soft Key Definitions

7.5.3.D.1 RF Gen Soft Key

Selects and indicates the On/Off state of the RF Generator output from the Test Set. When the generator is disabled, an RF OFF indicator is shown on the Tile.

7.5.3.D.2 RF Out Soft Key

The RF Out Soft Key controls the RF Output signal routing. Selects either the GEN (Generator) Connector or T/R Connector as RF Output port.

7.5.3.D.3 RF Offset Soft Key

Opens a soft key sub-menu that selects to Include or Exclude any set Analyzer or Generator Offset.

7.5.3.D.4 Gen Freq = Ana Freq + Dx Offset Soft Key

The Gen Freq = Ana Freq + Dx Offset Soft Key sets the RF Generator frequency to a value spaced from the RF Analyzer frequency as set in the Dx Offset field on the Generators Tile.

7.5.3.D.5 INC/DEC Soft Key

Opens a soft key sub-menu that increments or decrement a specific setting.

7.5.3.D.6 INC Gen Freq/DEC Gen Freq Soft Key

Each press of the soft key causes the RF Generator frequency to increment or decrement by the value set in the Freq Inc field on the Generators Tile.

7.5.3.D.7 INC Gen Level/DEC Gen Level Soft Key

Each press of the soft key causes the RF Generator level to increment or decrement by the value set in the Level Inc field on the Generators Tile.

7.5.3.D.8 INC Ana Freq/DEC Ana Freq Soft Key

Each press of the soft key causes the RF Analyzer frequency to increment or decrement by the value set in the Freq Inc (Analyzer) field on the Analyzers Tile.

7.5.3.D.9 DTMF Keypad Entry Soft Key

Selecting the DTMF Keypad Entry Soft Keys allows the user to generate DTMF tones using the Test Set's Data Entry Keypad and assigned soft keys. DTMF Waveform must be selected for the enabled Audio or Modulation Generator to simulate AF and Mod DTMF operation.

When using the AF or Mod DTMF A, B, C and D Soft Keys, the Test Set is operating in an Assigned function and the Return Soft Key must be pressed to resume Test Mode Operation.

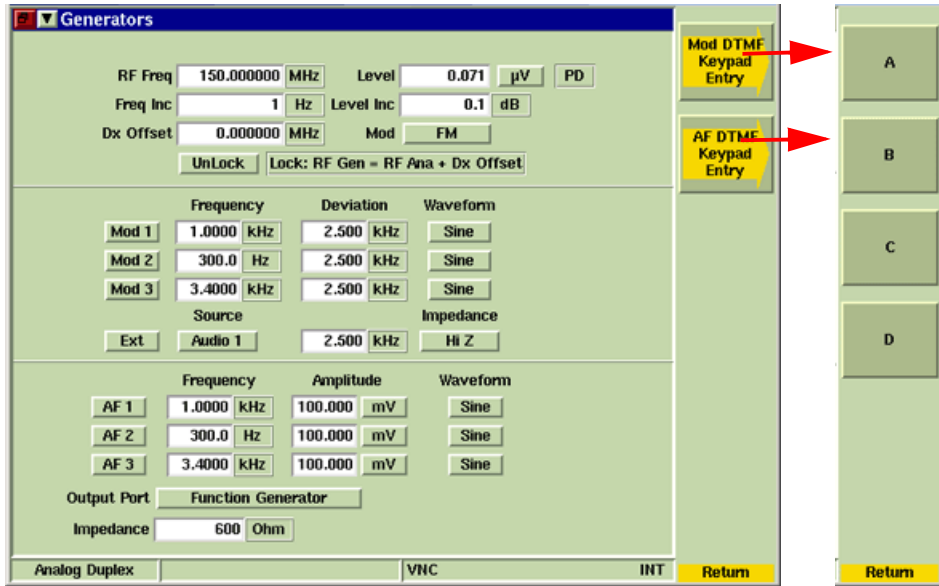

Fig. 7-38 DTMF Keypad Entry Soft Key Sub-menus

7.5.3.D.10 Return Soft Key

Returns to the top level soft key functions for the RF Generators Tile.

7.5.4 Harmonics and Spurious Measurements (390XOPT060)

The Harmonics and Spurious Measurements Option (390XOPT060) provides users with the ability to examine incremental readings at the 2nd and 3rd harmonics at a specified frequency and to obtain readings at the highest non-harmonic frequency spike over a defined frequency range. The Harmonics and Spurious Measurements and Configuration Tiles are only available when the Harmonics and Spurious Test Option (390XOPT060) is installed in the Test Set.

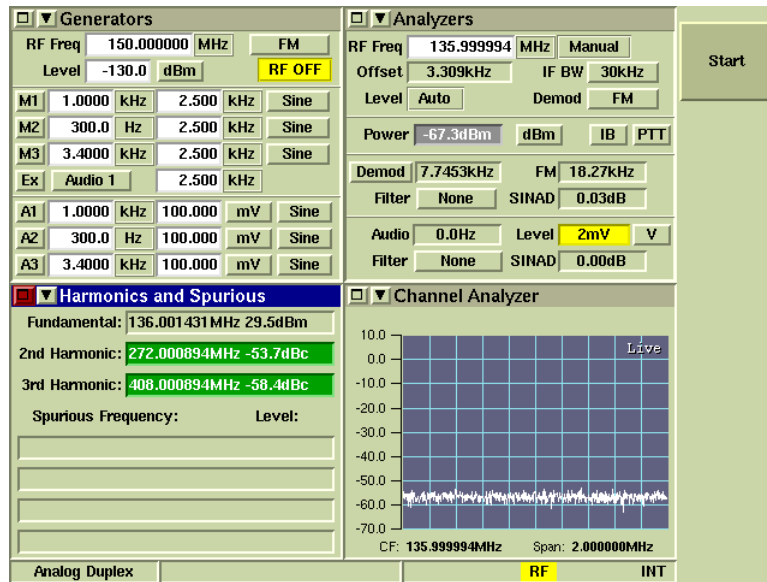

Fig. 7-39 Harmonics and Spurious Measurements Tile

7.5.4.A Field/Soft Key Definitions

7.5.4.A.1 Fundamental Frequency

Indicates the frequency at which Harmonic measurements are obtained.

7.5.4.A.2 Fundamental Level

Indicates the unit of measurement for Harmonic measurements.

7.5.4.A.3 Second Harmonic Level

Indicates reading at second harmonic level.

7.5.4.A.4 Third Harmonic Level

Indicates reading at third harmonic level.

7.5.4.A.5 Start Soft Key

Initiates harmonics and spurious measurement sweeps.

7.5.4.A.6 Spurious Measurements Field

Results area displays frequency at which non-harmonic frequency spikes are detected and the power level at that frequency. These fields are blank when no spurious measurements are detected above the Spurious Threshold level defined on the Harmonics and Spurious Configuration Tile.

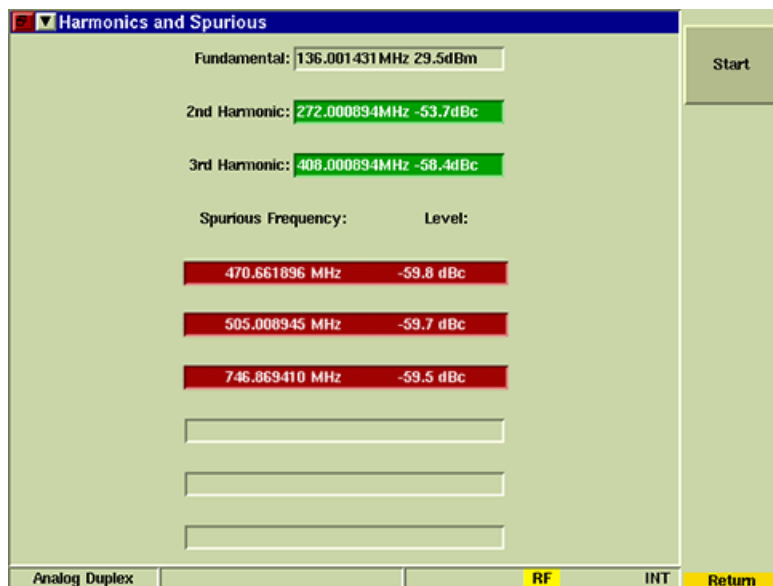

Fig. 7-40 Harmonics and Spurious Results

7.5.5 IQ Gen Modulation (390XOPT054)

IQ Gen (Generator) Modulation is an optional feature for the 3900 Series (390XOPT054) that allows users to download IQCreator waveform files to the 3900. This option only supports waveform files that have been created using IQCreator software. Refer to the IQCreator Getting Started Guide which is included on this CD for information on using IQCreator.

7.5.5.A Preliminary Procedures

IQCreator waveform files must be imported to the Test Set via the File Management Utility function prior to using the IQ Gen option.

7.5.5.B Accessing IQ Gen

The Analog Duplex System must be operating on the 3900 to utilize the IQ Gen. To select IQ Gen Modulation file:

- | STEP | PROCEDURE |
|------|---|
| 1. | Press the CONFIG Key twice to open the CONFIG Menu. |
| 2. | Select IQ Gen from the CONFIG floating menu. |
| 3. | Select the desired IQ File from the IQ File drop-down menu. After the file is selected, data fields on the IQ Gen Configuration Tile are filled with IQ File data information (refer to second example screen below). |

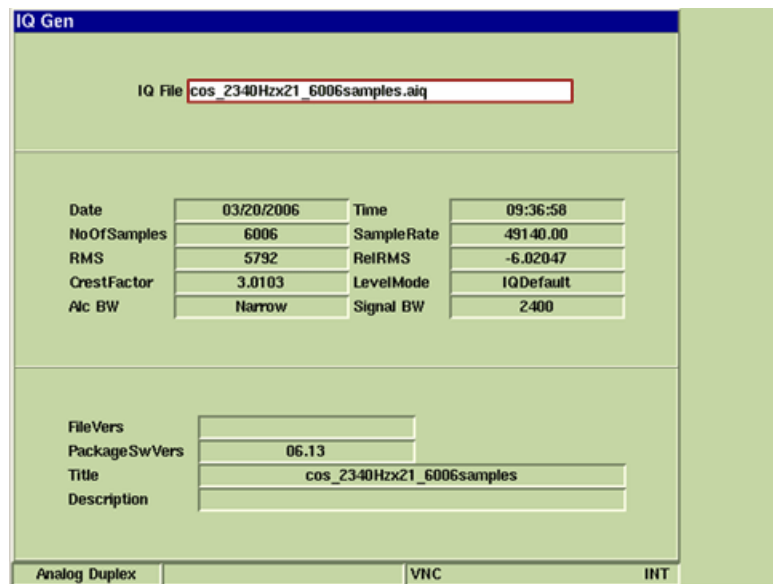

Fig. 7-41 IQ Gen Configuration Tile - File Data

- Press TEST Key to return to the Analog Duplex Test Tiles.

STEP

PROCEDURE

- Select IQ Gen from the Modulation drop-down menu on the Generators Tile. The Test Set now displays the selected IQ file.

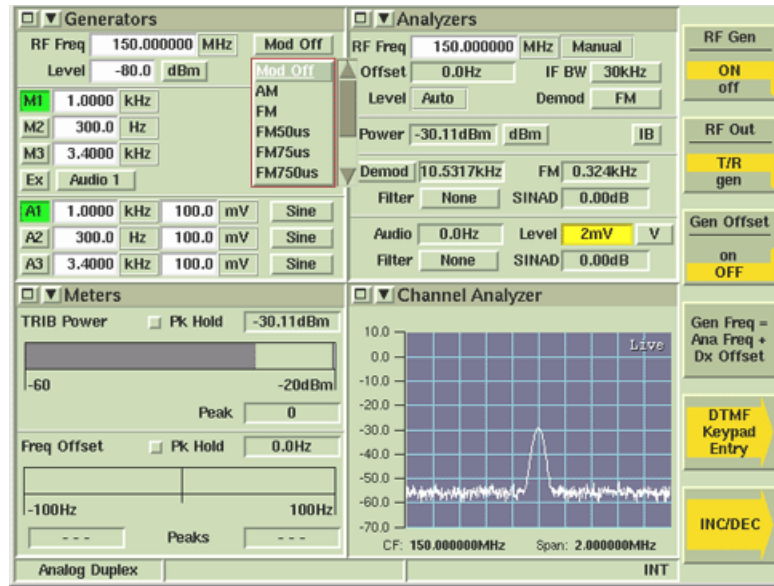

Fig. 7-42 IQ Gen Selection

7.5.6 Meters Tile

The Meters Tile displays the results of RF, AF and modulation measurements performed on signals from equipment under test. The fields present on the display vary according to the Demod setting selected on the Analyzers Tile.

When the Meters Tile is maximized (example above) six meters are displayed: up to three of these meters can be selected for display on the minimized Tile.

7.5.6.A Measurement Meter Types

7.5.6.A.1 Modulation Measurements

The type of modulation measurement meter displayed is dependent on the Demod setting on the Analyzers Tile. When Demod is set to FM, the FM Deviation Meter is displayed. When Demod is set to AM, the AM Depth Meter is displayed.

7.5.6.A.2 Noise Measurements

The type of noise measurement meter displayed is dependent on the type of noise meter selected (Distortion, SNR, SINAD and Hum & Noise) using the Noise Meters Soft Key.

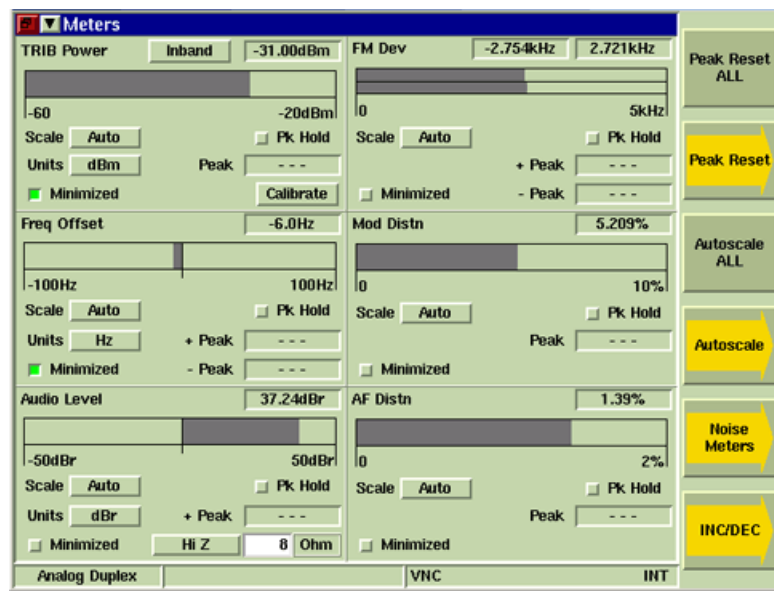

Fig. 7-43 Meters Tile - Maximized View

7.5.6.B Meter Definitions

7.5.6.B.1 AM Depth Meter

The AM Depth Meter measures the amount of AM modulation present on an AM Modulated RF Signal received by the 3900. The AM Depth measurement is displayed on the Analyzers and Meters Tiles.

7.5.6.B.2 Audio Level Meter

The Audio Level Meter measures the amplitude of audio signals applied to the Audio 1 and Audio 2 Connectors, allowing the user to evaluate the amplitude of the demodulated audio produced by a receiver under test. The amplitude measurement is displayed on the Analyzers and Meters Tiles. The Analyzers Tile allows the user to select an audio filter which filters the audio signal prior to measurement.

7.5.6.B.3 Distortion Meter

The AF Distortion Meter measures the amount of audio distortion a radio receiver may add to an audio signal during the demodulation process. The Modulation Distortion Meter measures the amount of audio distortion created by a radio transmitter when an audio signal is modulated. These meters are enabled using the Noise Meters Soft Key on the Analyzers or Meters Tiles.

7.5.6.B.4 FM Deviation Meter

The FM Deviation Meter measures the amount of deviation present on an FM Modulated RF Signal received by the 3900. The FM Deviation measurement is displayed on the Analyzers and Meters Tiles.

[FM RMS Meter](#)

The FM RMS Meter is selected from the FM Demod Measurement menu on the Mod Measurements Configuration Tile.

[FM Pk-PK/2 Meter](#)

The FM PK-PK/2 Meter is selected from the FM Demod Measurement menu on the Mod Measurements Configuration Tile.

7.5.6.B.5 Hum & Noise Meter

The AF Hum & Noise Meter measures the amount of hum and noise a radio receiver may add to the audio signal during the demodulation process. The Modulation Hum & Noise Meter measures the level of hum and noise created by a radio transmitter when an audio signal is modulated. The AF and Modulation Hum & Noise Meters are enabled using the Noise Meters Soft Key on the Analyzers or Meters Tiles.

7.5.6.B.6 Power Meter

The Power Meter measures the amplitude of an RF Signal received at the T/R or ANT Connector. When the ANT Connector is selected as the RF Input, the Power Meter displays the Inband power of the received RF Signal. The Inband Power Meter measures the strength of any signal present within the range of the selected IF Bandwidth Filter. When the T/R Connector is selected as the RF Input, the Power Meter can be configured to display Broadband or Inband Power measurements.

[Inband/BroadBand Toggle Button](#)

This button toggles between Inband and Broadband Power measurements. The Inband Power measurement function is available when either the ANT (Antenna) Connector or T/R Connector is selected for RF Input. The Inband/Broadband Toggle Button is only active when the T/R Connector is selected as the RF Input source.

7.5.6.B.7 RF Frequency Offset (when not Autotuned)

When the Manual method of setting the RF input level is selected on the Analyzers Tile, this field indicates the difference between the RF input signal and the defined tuned analyzer frequency.

The Frequency Offset bar graph has a center zero for positive or negative readings. The Scale drop-down menu selects setting.

The Units drop-down menu selects the unit of measure used to display Frequency Offset measurements.

7.5.6.B.8 Sinad Meter

The AF Sinad Meter measures the receive quality of a radio receiver. The Modulation Sinad Meter measures the sinad of a transmitter. The AF and Modulation Sinad Meters are enabled using the Noise Meters Soft Key on the Analyzers or Meters Tiles.

7.5.6.B.9 SNR Meter

The AF SNR Meter measures the signal to noise ratio of an audio source. The Modulation SNR Meter measures the signal to noise ratio of a radio transmitter. The AF and Modulation SNR Meters are enabled using the Noise Meters Soft Key on the Analyzers or Meters Tile.

7.5.6.C Meter Components

7.5.6.C.1 Measurement Readout

The measurement results are displayed as a digital readout at the top right of the meter panel. For some measurements such as AM Depth, the positive and negative values of the measurements are given.

7.5.6.C.2 Bar Graphs

The Bar Graph is a single, linear indicator that provides a visual measurement reading based on a user defined scale. Upper and lower limit indicators are set on system Configuration Tiles.

7.5.6.C.3 Scale

The scale of the bar graph is selected from the Scale drop-down menu. Available settings are Auto-ranging (Auto) or a fixed value. The selected scale value is displayed below the bar graph.

7.5.6.C.4 Peak (Pk) Hold

Selecting the Peak Hold button allows the peak value of measurements to be captured and updated as new peaks occur. The peak value is shown on the bar graph and in the Peak digital readout field.

7.5.6.C.5 Peak Measurement

Shows the peak value from the bursts measured. The peak reading can be reset by using either the Peak Reset ALL Soft Key, which resets all measurements or by using the Peak Reset Soft Key to reset an individual measurement selected from the soft key menu. The reset operation also resets the peak reading on the bar graph.

7.5.6.C.6 Minimize Button

This button selects the meter for display on the minimized Tile. Up to 3 meters can be displayed on the minimized display: a warning appearing if more than three are selected. The information shown on the minimized display for each measurement is reduced when multiple measurements are selected.

7.5.6.C.7 Peak Reset ALL Soft Key

Resets all active peak hold levels to zero.

7.5.6.C.8 Peak Reset Soft Key

Displays a soft key sub-menu that resets the peak hold on a specific meter or meters.

7.5.6.C.9 Autoscale ALL Soft Key

Sets all meter bar graphs to Auto-ranging.

7.5.6.C.10 Autoscale Soft Key

Displays a soft key sub-menu containing soft keys that set the bar graph on a specific meter or meters to Auto-ranging.

7.5.6.C.11 Noise Meters Soft Key

Opens a soft key sub-menu that allows measurement option to be selected to be displayed on the Meters Tile for Modulation Distortion and AF Distortion measurement.

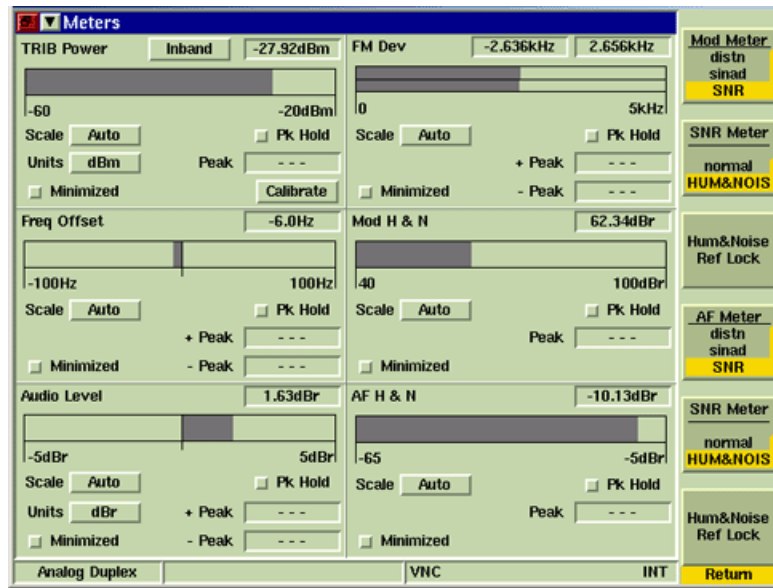

Fig. 7-44 Analog Duplex Meters Tile - SINAD Meters Selected

7.5.6.C.12 Mod Meter Soft Key

Selects type of measurement to be displayed in Modulation Meter. Selecting SNR (Signal to Noise Ratio) enables the SNR Meter Soft Key which allows user to select the type of SNR measurement to be performed (Normal SNR or Hum & Noise).

7.5.6.C.13 SNR (Mod) Meter Soft Key

Selects the type of Mod/AF SNR measurement to be performed, either Normal or Hum & Noise. The SNR Meter Soft Keys are only available when SNR is selected on the Mod Meter and/or AF Meter Soft Keys.

Mod SNR Normal

When the Normal Mod SNR Meter is selected, the Test Set transmits an audio signal to a radio under test in an ON/OFF cycle. The internal signal of the radio under test is modulated with the audio signal it receives from the Test Set. The radio under test sends this modulated signal back to the Test Set. The Test Set receives and demodulates the signal received from the radio under test. The ratio of the level of the demod audio signal when the Mod Generator is ON versus the level when the Mod Generator is OFF is the SNR reading.

Mod SNR Hum & Noise

The Mod SNR Hum & Noise reading measures the transmitter of the radio under test. SNR Hum & Noise is a measurement of the level of the audio signal that is demodulated by the Test Set when the radio sends a modulated signal versus when the signal is not modulated.

To use the Mod SNR Meter to obtain Mod Hum & Noise measurements:

STEP PROCEDURE

1. Connect the transmitter of the radio under test to the Test Set.
2. Add modulation at the desired level to the radio under test.
3. Press the Hum & Noise Ref Lock Soft Key to obtain a reference lock of the demodulated signal received by the Test Set.
4. Remove the modulation from the radio under test.
5. The Test Set displays the Mod SNR Hum & Noise measurement relative to the level of the demodulated received signal when the radio under test was being modulated.

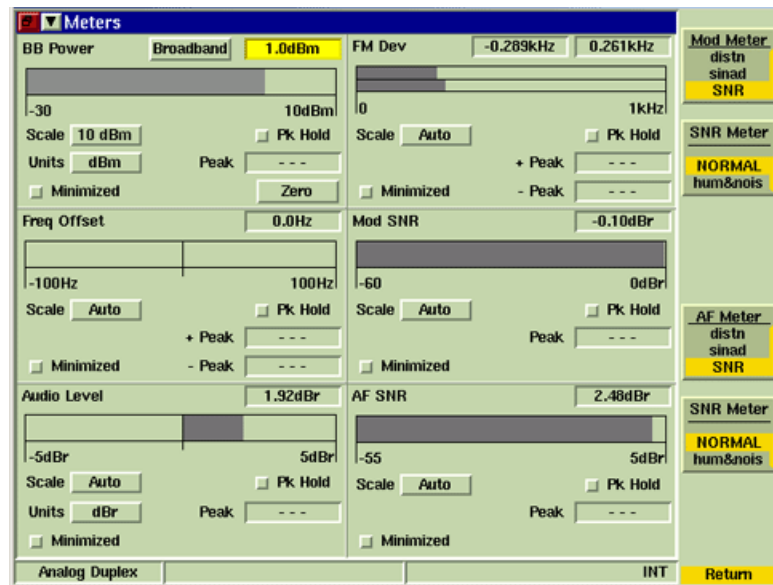

Fig. 7-45 Analog Duplex Meters Tile - Hum & Noise SNR Selected

7.5.6.C.14 AF Meter Soft Key

Selects the type of AF SNR measurement to be performed, either Normal or Hum & Noise. This soft key is only available when SNR is selected on the AF Meter Soft Key.

7.5.6.C.15 AF SNR Meter Soft Key

Selects the type of AF SNR measurement to be performed, either Normal or Hum & Noise. This soft key is only available when SNR is selected on the AF Meter Soft Key.

AF SNR Normal

When the Normal AF SNR Meter is selected the Test Set transmits a user defined, modulated RF signal to a radio under test. The Test Set transmits the signal, cycling the modulation ON and OFF while the signal is being transmitted. The desired modulated signal must be enabled before the SNR Meter Soft Key is selected. The radio under test demodulates the signal it receives from the Test Set and sends an audio signal back to the Test Set (via the Audio In connectors). The ratio of the level of the audio in the modulated signal versus the level of audio in the demodulated signal is the SNR reading.

AF SNR Hum & Noise

The AF SNR Hum & Noise reading measures the receiver of the radio under test. AF SNR Hum & Noise is a measurement of the level of the audio signal that is demodulated by the radio when the Test Set sends a modulated signal versus when the signal is not modulated.

To use the AF SNR Meter to obtain Hum & Noise measurements:

STEP	PROCEDURE
1.	Connect the transmitter of the Test Set to the radio under test.
2.	Connect the demodulated audio of the radio under test to on of the Test Set's Audio In Connectors.
3.	Add modulation at the desired level to the Test Set.
4.	Press the Hum & Noise Ref Lock Soft Key to obtain a reference lock of the audio in the signal received by the Test Set.
5.	Remove the modulation from the Test Set's transmitted signal.
6.	The Test Set displays the AF SNR Hum & Noise measurement relative to the level of the audio in the signal when the Test Set was being modulated.

7.5.6.C.16 Hum & Noise Ref Lock Soft Key

Sets a reference lock to the current Hum & Noise Meter reading. This soft key is only available when Hum & Noise SNR is selected on the SNR Meter or AF Meter Soft Key.

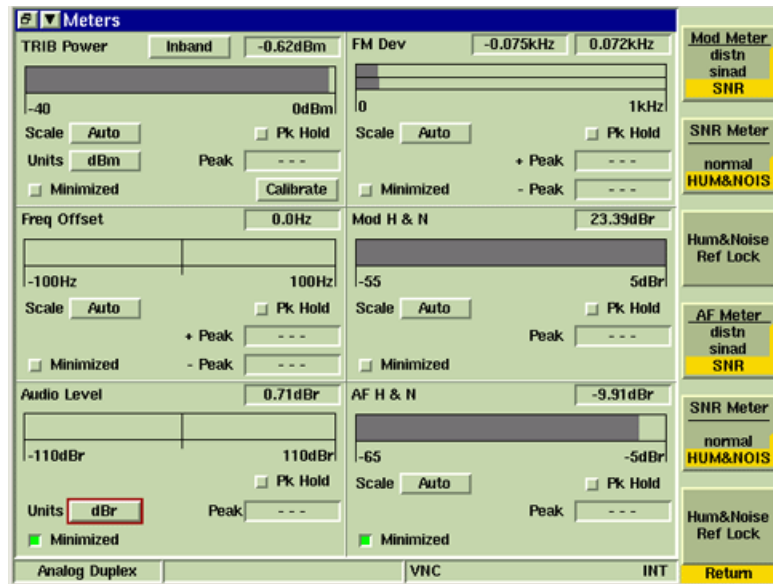

Fig. 7-46 Analog Duplex Meters Tile - Zeroing Hum & Noise Meter

7.5.6.C.17 INC/DEC Soft Key

Opens a soft key sub-menu that increments or decrement a specific setting.

7.5.6.C.18 INC Gen Freq/DEC Gen Freq Soft Key

Each press of the soft key causes the RF Generator frequency to increment or decrement by the value set in the Freq Inc field on the Generators Tile.

7.5.6.C.19 INC Gen Level/DEC Gen Level Soft Key

Each press of the soft key causes the RF Generator level to increment or decrement by the value set in the Level Inc field on the Generators Tile.

7.5.6.C.20 INC Ana Freq/DEC Ana Freq Soft Key

Each press of the soft key causes the RF Analyzer frequency to increment or decrement by the value set in the Freq Inc (Analyzer) field on the Analyzers Tile.

7.5.6.C.21 Return Soft Key

Returns to the top level soft key functions for the RF Generators Tile.

7.5.7 Site Monitoring Application Test Option (390XOPT051)

The Sensitivity Search Tile is enabled when the Site Monitoring Application Test Option (390XOPT051) is installed in the Test Set. The Sensitivity Search Tile is used to log the Sinad measurement of an injected signal over time. Sensitivity Search is also used to log the spectrum trace of the RF signal. Sensitivity Search data files are referred to throughout this section as Data Log Files.

Refer to Application Note 46891/951, Using the VIAVI 3900 Series for Remote Site Monitoring, for additional information on use of this option.

7.5.7.A Accessing Site Monitoring

The Sensitivity Search Tile is selected from the Measurement drop-down menu on any of the Analog Duplex Test Tiles. This Tile is only available when the Site Monitoring Application is installed in the Test Set.

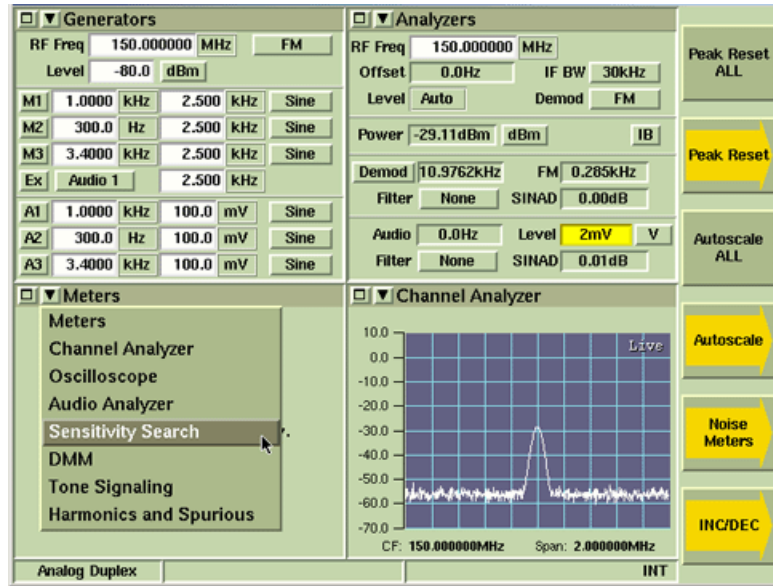

Fig. 7-47 Selecting Sensitivity Search Tile



Fig. 7-48 Main Sensitivity Search Tile - Maximized View

7.5.7.B Field/Soft Key Definitions

The Sensitivity Search Test Tile contains parameters that must be defined to perform a Site Monitoring test.

7.5.7.B.1 Sinad

Sets the reference point from which all readings are taken.

7.5.7.B.2 Interval

Defines how frequently readings are logged to the file for the duration of the search.

7.5.7.B.3 Average

Defines the number of readings to be averaged to calculate measurements.

7.5.7.B.4 Duration

Defines the length of time over which readings are taken.

7.5.7.B.5 Filter

Selects a measurement filter to include in the measurement path.

7.5.7.B.6 Source

Selects signal source of input signal.

7.5.7.B.7 File Name

Indicates the Data Log File currently running or being displayed on Sensitivity Search Tiles. The File name is limited to 18 characters and can not contain any blank spaces. The Test Set logs data to the last selected Data Log File until a new file name is assigned.

7.5.7.B.8 Logging Start/Stop Soft Key

Starts and stops logging data. When Status is Running, the Sensitivity Search Tile appears as shown in example below. When logging is complete, display Tile defaults back to Main Sensitivity Search Tile.

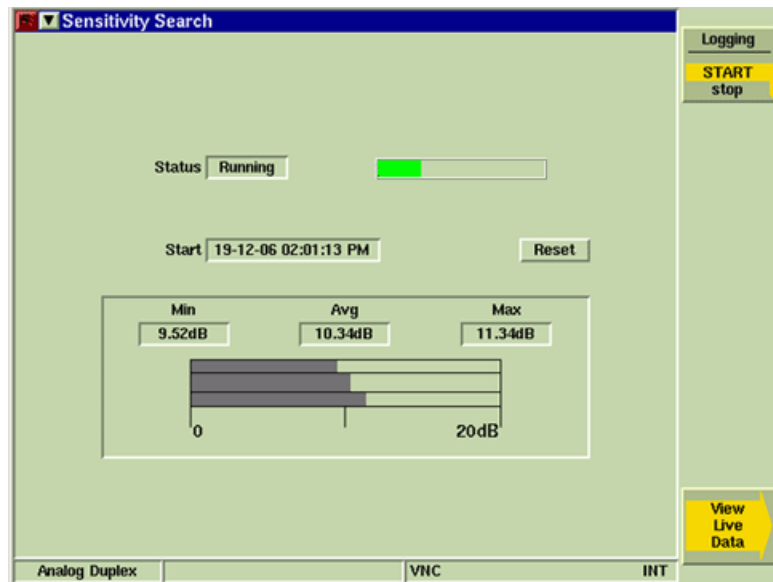

Fig. 7-49 Sensitivity Search Tile - Log Running

7.5.7.B.9 View Live Data Soft Key

Opens soft key sub-menu that allows user to view data as if it acquired. This soft key is only available while data is being logged (Status field indicates Running).

7.5.7.B.10 Logging Soft Key

Displays log file as data is acquired. This soft key is accessed by pressing the View Live Data Soft Key while Data Log is running.

7.5.7.B.11 Plot Soft Key

Displays graph plot of data as it is acquired. This soft key is accessed by pressing the View Live Data Soft Key while data is being logged.

7.5.7.B.12 Spectrum Soft Key

Displays Spectrum Analyzer plot of data as it is acquired. This soft key is only available while data is being logged.

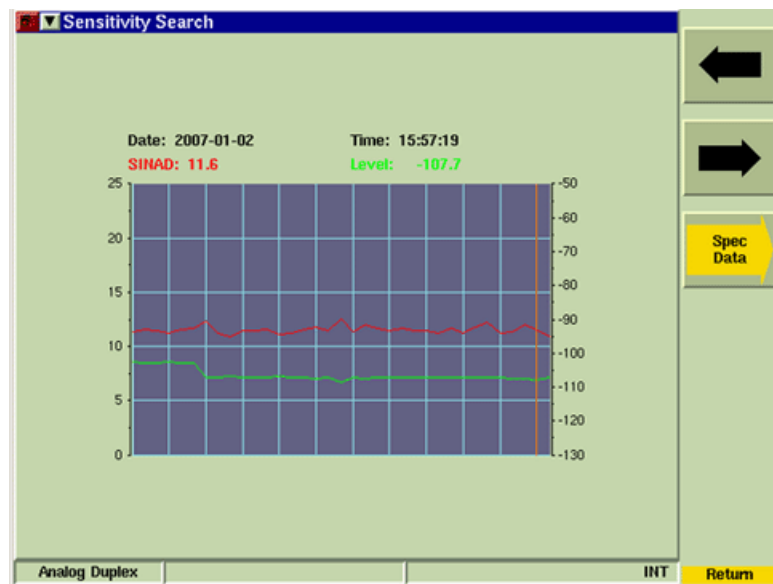

Fig. 7-50 View Live Data Soft Key Sub-menu

7.5.7.B.13 Default Soft Key

Displays Main Sensitivity Search Tile.

7.5.7.B.14 View Post Data Soft Key

Opens soft key sub-menu that allows user to review saved Data Log Files. This soft key is only available after data acquisition has stopped.

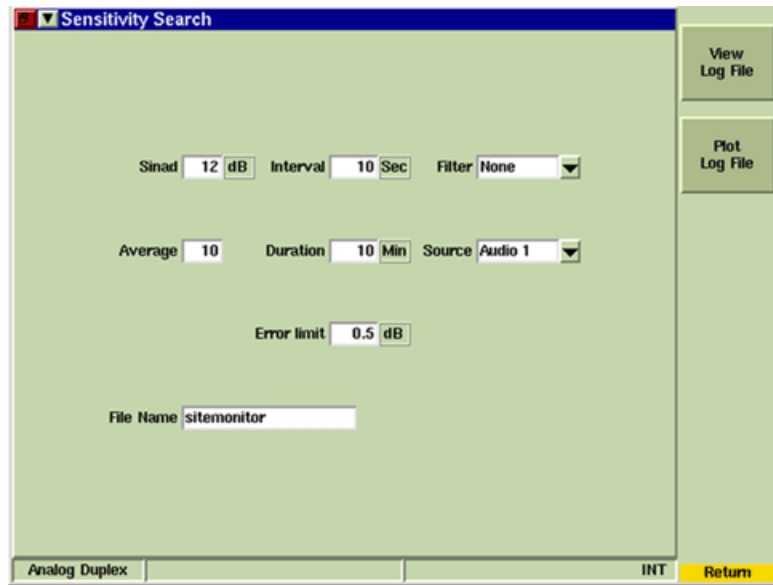

Fig. 7-51 Sensitivity Search - View/Post Data Tile

7.5.7.B.15 Calibration Soft Key

Initiates Sensitivity Search Calibration function. Unit under test must be configured and connected to Test Set prior to running calibration.

7.5.7.B.16 Spec Data Soft Key

Displays logged data on a Spectrum Analyzer plot field. Data can be viewed while data is being logged and after logging stops.

7.5.7.B.17 File Manager Soft Key

Opens a soft key sub-menu that allows user to navigate between or delete existing Data Log Files.

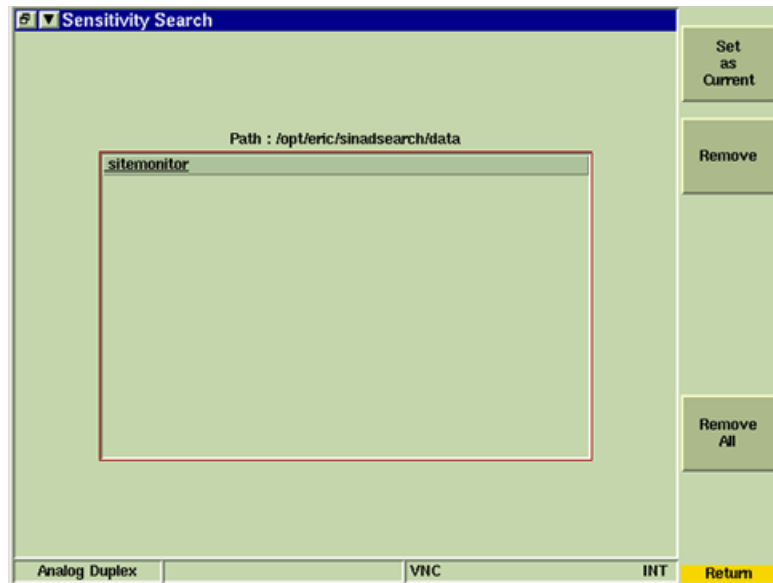

Fig. 7-52 Sensitivity Search - File Manager Tile

7.5.7.B.18 View Log File Soft Key

Displays list of Data Log Files. Data Log Files include date and time of test, the Sinad reading and Power Level readings at each recorded interval. The View Log Soft Key is accessed by pressing the View Post Data Soft Key after data logging has stopped. Scroll Up and Scroll Down Soft Keys navigate through the data log when Mouse option is not being used.

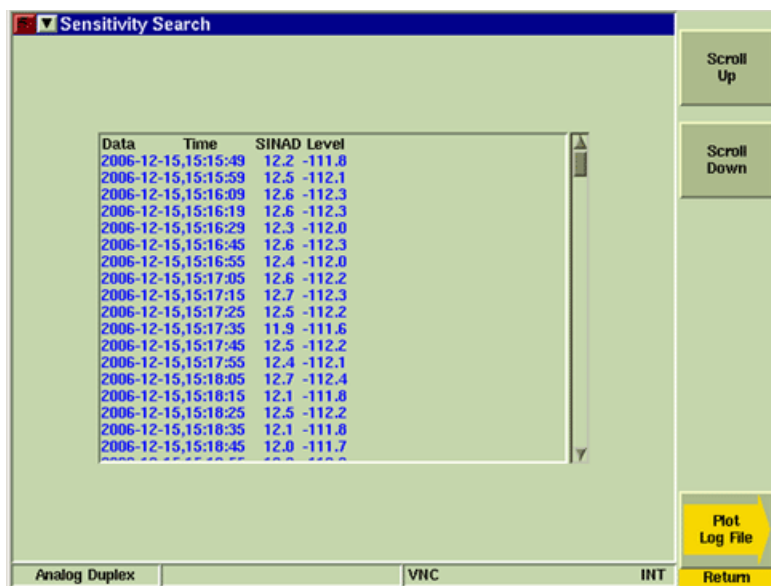

Fig. 7-53 Logged Data File

7.5.7.B.19 Plot Log File Soft Key

Displays logged data on a graph plot. Directional arrow soft keys allow user to navigate to points along the acquired signal.

7.5.7.B.20 Spec Data Soft Key

Displays logged data on a Spectrum Analyzer plot field. Data can be viewed while data is being logged and after logging stops.

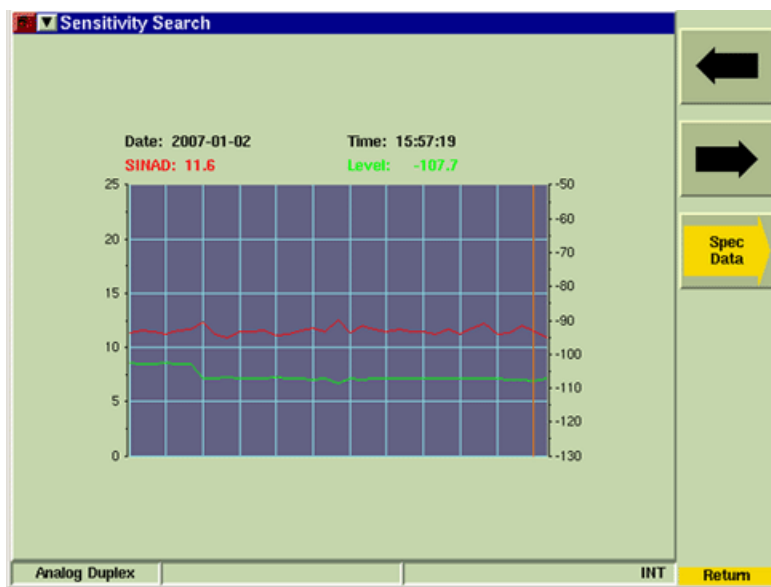

Fig. 7-54 Logged Data - Plot Log Soft Key Sub-menu

7.5.7.C Managing Log Files

7.5.7.C.1 Open Existing Log File

STEP	PROCEDURE
------	-----------

1. Press File Manager Soft Key.
2. Select the desired file name from list.
3. Press Set as Current Soft Key.

7.5.7.C.2 To add to an existing Data Log File:

STEP	PROCEDURE
------	-----------

1. Press File Manager Soft Key.
2. Select desired Data Log File from list and press Set as Current Soft Key.
3. Press Return, then Logging Soft Key to start logging data to the selected Data Log File.

7.5.7.C.3 To Create New Data Log File

STEP	PROCEDURE
------	-----------

1. Select File Name field on main Sensitivity Search Tile.
2. Enter desired file name in field.
3. Data is automatically saved under designated file name when Logging Soft Key is pressed.

7.5.7.C.4 Delete Log File

STEP	PROCEDURE
------	-----------

1. Press File Manager Soft Key.
2. Select the desired file name from list.
3. Press Remove Soft Key to remove selected Data Log File or press Remove All Soft Key to delete all Data Log Files.

7.5.8 Tone Decoding Tile

The 3900 Tone Decoding Test function was developed to provide users with the ability to decode received audio and modulated signals.

NOTE

The Test Set can not decode a received signal if the signal is squelched (the Test Set's Squelch setting is too high).

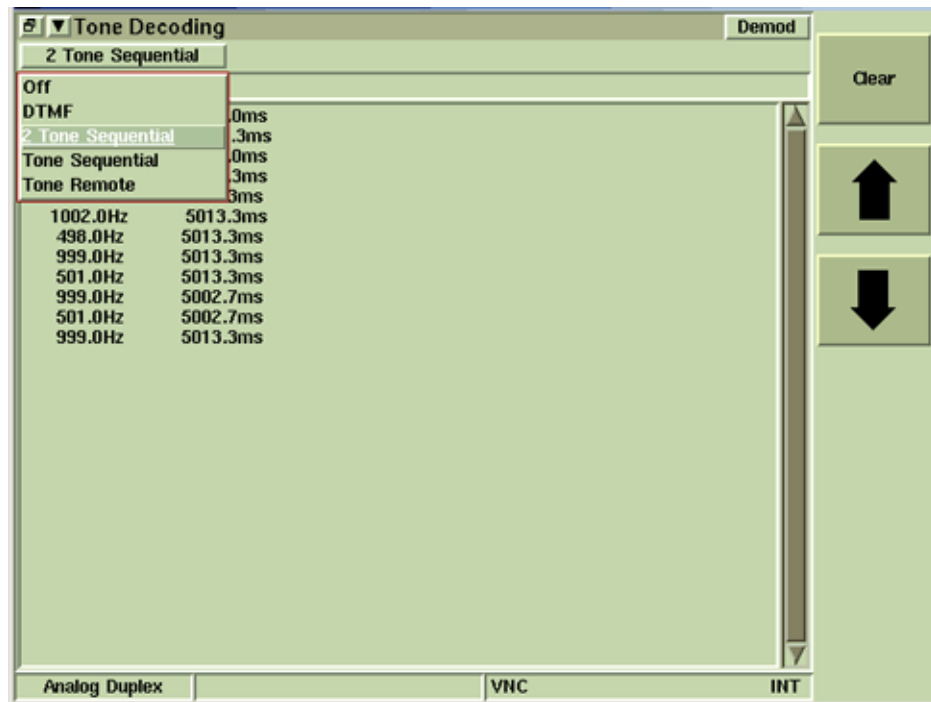

Fig. 7-55 Tone Decoding Tile

7.5.8.A Field/Soft Key Definitions

7.5.8.A.1 Input Signal Routing

The Tone Decoding Input Connector is selected from the Source drop-down menu on the Analyzers Tile.

7.5.8.A.2 Tone Type

The type of tone to be decoded is selected from the Type drop-down menu. The type of generator is selected from the Generator drop-down menu. Available parameters update according to the type of tone selected.

The Tone Type menu on the Tone Decode Tile and the Demod Code Type menu on the Analyzers are linked parameters. When DTMF, Two Tone Sequential, Tone Sequential or Tone Remote are selected as the Tone Types on the Tone Decoding Tile the Demod Code Type on the Analyzers Tile updates to Demod (Off). When either DCS or DCSINV are selected as the Demod Decode Types on the Analyzers Tile the Tone Type on the Tone Decode type updates to OFF.

7.5.8.A.3 Protocol

The Protocol drop-down menu is enabled when the Tone Type is set to Tone Sequential. This menu selects the type of Protocol that is expected in the received Tone Sequential signal.

Pressing the Clear Soft Key clears and resets the data logged on the Tone Decoding Tile.

7.5.9 Tone Encoding Tile

The 3900 Tone Encoding Test function was developed to provide users with the ability to test the performance of tone-activated pagers and control systems.

3900 Tone Encoding currently supports the following tone types:

- [Tone Remote \(Mod Gen\)](#)
- [Tone Remote \(Audio Gen\)](#)
- [Tone Sequential \(Mod Gen\)](#)
- [Tone Sequential \(Audio Gen\)](#)
- [Tone Sequential \(Mod Gen\)](#)
- [2 Tone Sequential \(Audio Gen\)](#)

7.5.9.A Selecting Tone and Generator Type

The type of tone to be encoded is selected from the Type drop-down menu. The type of generator is selected from the Generator drop-down menu. Available parameters update according to the type of tone and generator selected.

NOTE

When the Start Soft Key is pressed the Tone Encoding AF or Modulation Generator occupies AF Generator 1 or Mod Generator 1 on the Generators Tile. When this occurs, the Tone Type selected on the Tone Encoding Tile over-rides the Waveshape selected on AF Generator 1 or Mod Generator 1 for the duration of the tone sequence.

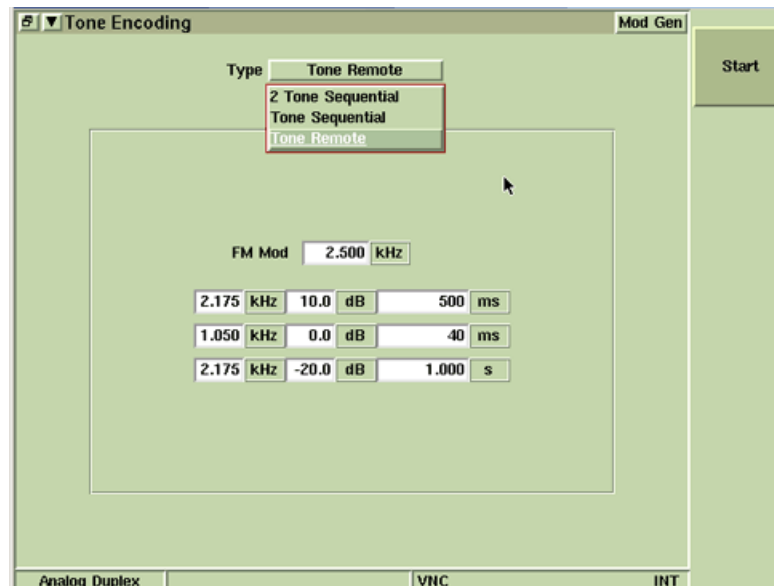

Fig. 7-56 Tone Type and Generator Selection

7.5.9.B Output Signal Routing

7.5.9.B.1 Modulation Generator

When Mod Gen is selected, the encoded signal is routed to the modulator and transmitted out the selected RF Output Connector (T/R or GEN).

7.5.9.B.2 Audio Generator

When Audio Gen is selected, the Function Generator/Demod Out Connector is the only valid output connector. The output connector is selected from the Output Port drop-down menu on the Generators Tile.

7.5.9.C Tone Remote (Mod Gen)

Tone Remote signaling generates three tone sequences that the Test Set uses for Tone Remote Encoding. The ability to define three separate components provides users with the ability to determine if the UUT is properly processing the received audio tone remote sequences.

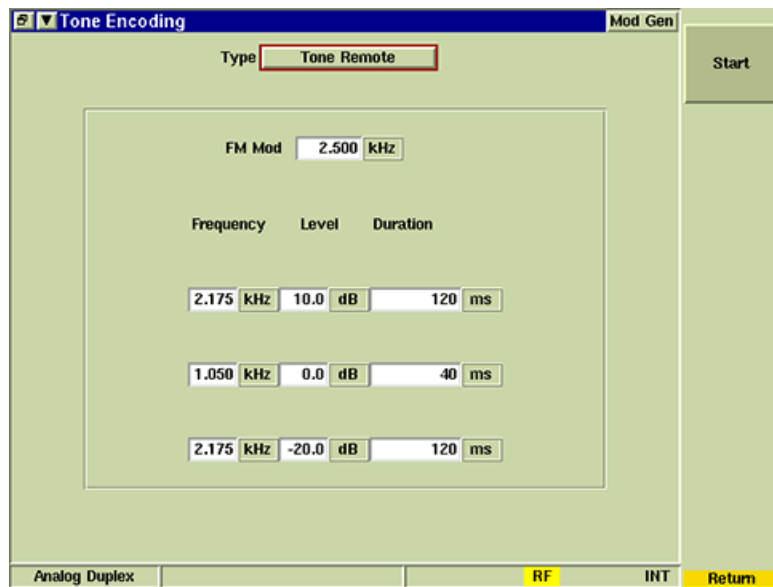

Fig. 7-57 Tone Remote - Modulation

7.5.9.C.1 Field/Soft Key Definitions

FM Modulation

The FM Modulation field defines the deviation value for Tone Remote encoding.

Frequency

The frequency field defines the Gen Modulation Frequency for each Tone Remote component.

Level

The Mod Level field defines signal Level for each Tone Remote component.

Duration

The Duration field defines the length of time each Tone Remote component is emitted.

Start Soft Key

Pressing the Start Soft Key begins sending the selected tone sequence as defined by the selected format.

When the Start Soft Key is pressed the Tone Encoding AF or Modulation Generator occupies AF Generator 1 or Mod Generator 1 on the Generators Tile. When this occurs, the Tone Type selected on the Tone Encoding Tile over-rides the Waveshape selected on AF Generator 1 or Mod Generator 1 for the duration of the tone sequence.

7.5.9.D Tone Remote (Audio Gen)

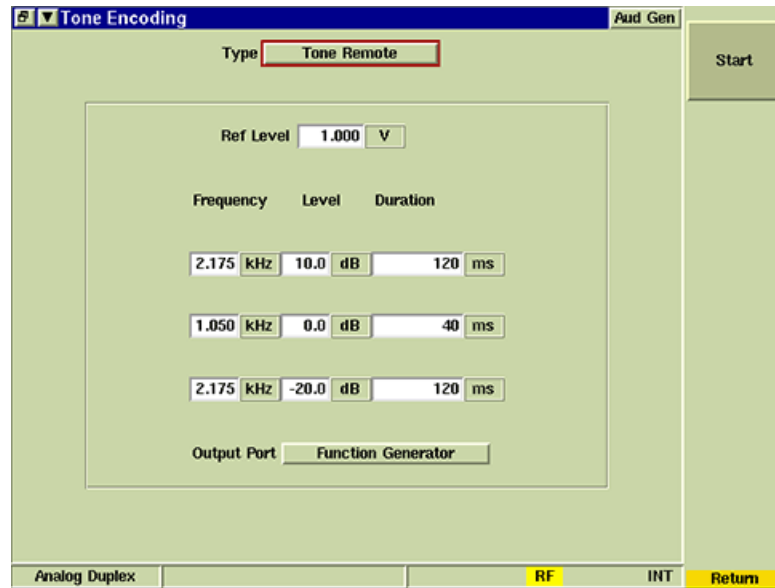

Fig. 7-58 Tone Remote - Audio

7.5.9.D.1 Field/Soft Key Definitions

Reference Level

The Ref Level field defines the Reference signal Level for Tone Remote Encoding.

Frequency

The frequency field defines the Audio Frequency for each Tone Remote component.

Level

The Audio Level field defines signal Level for each Tone Remote component.

Duration

The Duration field defines the length of time each Tone Remote component is emitted.

Start Soft Key

Pressing the Start Soft Key begins sending the selected tone sequence as defined by the selected format.

When the Start Soft Key is pressed the Tone Encoding AF or Modulation Generator occupies AF Generator 1 or Mod Generator 1 on the Generators Tile. When this occurs, the Tone Type selected on the Tone Encoding Tile over-rides the Waveshape selected on AF Generator 1 or Mod Generator 1 for the duration of the tone sequence.

7.5.9.E Tone Sequential (Mod Gen)

Tone Sequential signaling allows the user to select a tone sequence protocol and a tone sequence code to emit. This functionality provides the user with ability to determine if the UUT is properly processing the received sequential tone sequence.

Fig. 7-59 Tone Sequential - Modulation

7.5.9.E.1 Field/Soft Key Definitions

FM Modulation

The FM Modulation field defines the deviation value for Tone Sequential Encoding.

Protocol

The Protocol drop-down menu selects the type of Protocol used in the Encoded Tone Sequential signal.

Code

The Code field defines the code sequence emitted by the Test Set.

Frequency Shift

The Frequency Shift field defines the frequency shift applied to the frequency of tones transmitted by the Modulation Generator.

Pause

The Pause field defines how long the Modulation Generator pauses before sending the first Tone.

Call Delay

The Call Delay field defines how long the Modulation Generator extends the first tone in the tone sequence.

Start Soft Key

Pressing the Start Soft Key begins sending the selected tone sequence as defined by the selected format. When the Start Soft Key is pressed the Tone Encoding AF or Modulation Generator occupies AF Generator 1 or Mod Generator 1 on the Generators Tile. When this occurs, the Tone Type selected on the Tone Encoding Tile over-rides the Waveshape selected on AF Generator 1 or Mod Generator 1 for the duration of the tone sequence.

7.5.9.F Tone Sequential (Audio Gen)

Fig. 7-60 Tone Sequential - Audio

7.5.9.F.1 Field/Soft Key Definitions

Level

The Level field defines the Level value for Tone Sequential Encoding.

Protocol

The Protocol drop-down menu selects the type of Protocol used in the Encoded Tone Sequential signal.

Code

The Code field defines the code sequence emitted by the Test Set.

Output Port

The output signal from the AF Generator is routed to the FCTN GEN/DEMODO Connector. The FCTN GEN/DEMODO Connector is also used for Demodulated Signal output. The Output Port is selected from this drop-down menu.

When a filtered output option is selected, the filter type is selected from the Psoph filter drop-down menu on the AF Measurements Configuration Tile or Modulation Measurements Configuration Tile.

NOTE

Changing configuration to Demod Out while still connected to the MIC/AF Input of a radio under test may create a feedback loop.

Frequency Shift

The Frequency Shift field defines the frequency shift applied to the frequency of tones transmitted by the AF Generator.

Pause

The Pause field defines how long the AF Generator pauses before sending the first Tone.

Call Delay

The Call Delay field defines how long the AF Generator extends the first tone in the tone sequence.

Start Soft Key

Pressing the Start Soft Key sends a single Tone for the specified length of time (Duration). When the Start Soft Key is pressed the Tone Encoding AF or Modulation Generator occupies AF Generator 1 or Mod Generator 1 on the Generators Tile. When this occurs, the Tone Type selected on the Tone Encoding Tile over-rides the Waveshape selected on AF Generator 1 or Mod Generator 1 for the duration of the tone sequence.

7.5.9.G 2 Tone Sequential (Mod Gen)

Two Tone Sequential signaling allows the user to configure the 3900 to generate two tones at a specified frequency for a defined length of time. Tone A is the first tone, Tone B is the second tone. The ability to define different tones allows the user to determine if the UUT is properly processing the received audio tone sequence.

7.5.9.G.1 Field/Soft Key Definitions



Fig. 7-61 Two Tone Sequential - Modulation

FM Modulation

The FM Modulation field defines the deviation value for Tone A and Tone B.

Tone A/B Frequency

The frequency field defines the Tone A and Tone B Frequency for the Gen Modulation Frequency.

Tone A/B Duration

The Duration field defines the length of time Tone A and Tone B are emitted.

Start Soft Key

Pressing the Start Soft Key begins sending the selected tone sequence as defined by the selected format. When the Start Soft Key is pressed the Tone Encoding AF or Modulation Generator occupies AF Generator 1 or Mod Generator 1 on the Generators Tile. When this occurs, the Tone Type selected on the Tone Encoding Tile over-rides the Waveshape selected on AF Generator 1 or Mod Generator 1 for the duration of the tone sequence.

7.5.9.H 2 Tone Sequential (Audio Gen)

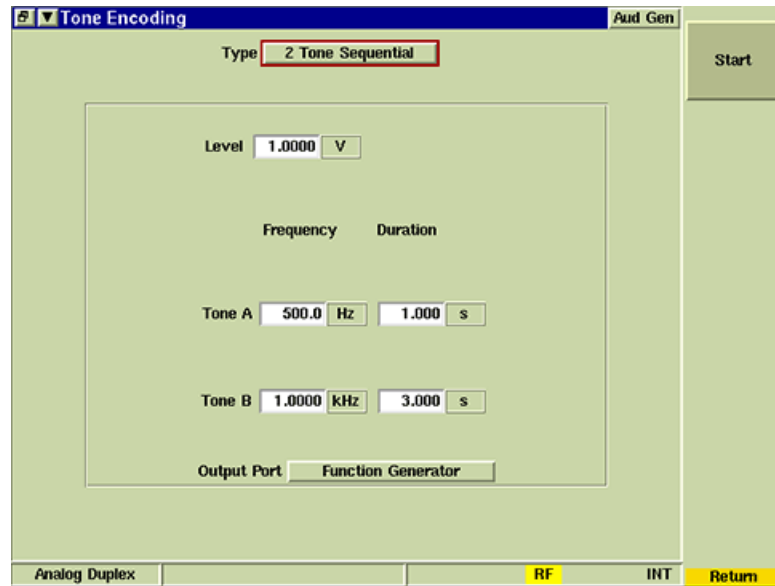

Fig. 7-62 Two Tone Sequential - Audio

7.5.9.H.1 Field/Soft Key Definitions

Level

The Audio Level field defines signal Level for Tone A and Tone B.

Tone A/B Frequency

The frequency field defines the Tone A and Tone B Frequency for the AF Generator Frequency.

Tone A/B Duration

The Duration field defines the length of time Tone A and Tone B are emitted.

Output Port

The output signal from the AF Generator is routed to the FCTN GEN/DEMODO Connector. The FCTN GEN/DEMODO Connector is also used for Demodulated Signal output. The Output Port is selected from this drop-down menu.

When a filtered output option is selected, the filter type is selected from the Psoph filter drop-down menu on the AF Measurements Configuration Tile or Modulation Measurements Configuration Tile.

NOTE

Changing configuration to Demod Out while still connected to the MIC/AF Input of a radio under test may create a feedback loop.

Start Soft Key

Pressing the Start Soft Key sends a single Modulated Tone A burst for the specified length of time (Duration), followed by a single Modulated Tone B burst for the specified length of time.

When the Start Soft Key is pressed the Tone Encoding AF or Modulation Generator occupies AF Generator 1 or Mod Generator 1 on the Generators Tile. When this occurs, the Tone Type selected on the Tone Encoding Tile over-rides the Waveshape selected on AF Generator 1 or Mod Generator 1 for the duration of the tone sequence.

THIS PAGE INTENTIONALLY LEFT BLANK.

Chapter 8 - 3900 Optional Functions

8.1 INTRODUCTION

This chapter lists and describes optional test features and functions that are available for use in the 3900 Test Set.

NOTE

Some of these options are supported in systems other than Analog Duplex (i.e., Audio Analyzer Option 390XOPT055 is supported in P25, DMR and TETRA Systems).

8.2 OPTIONAL INSTRUMENT FUNCTIONS

8.2.1. Audio Analyzer (390XOPT055)

The Audio Analyzer is an optional feature (390XOPT055) that allows users to evaluate the audio frequency band of a demodulated or externally input signal. The Audio Analyzer is only available when the Audio Analyzer Option (390XOPT055) has been installed in the Test Set.

8.2.1.A Basic Settings

The frequency span of the display must include the AF Frequency being examined. The Reference Level of the display must be set so that the AF signal level falls within the display area.

8.2.1.B Accessing the Audio Analyzer

The Audio Analyzer is accessed from the drop-down menus on System Test Measurements Tiles.

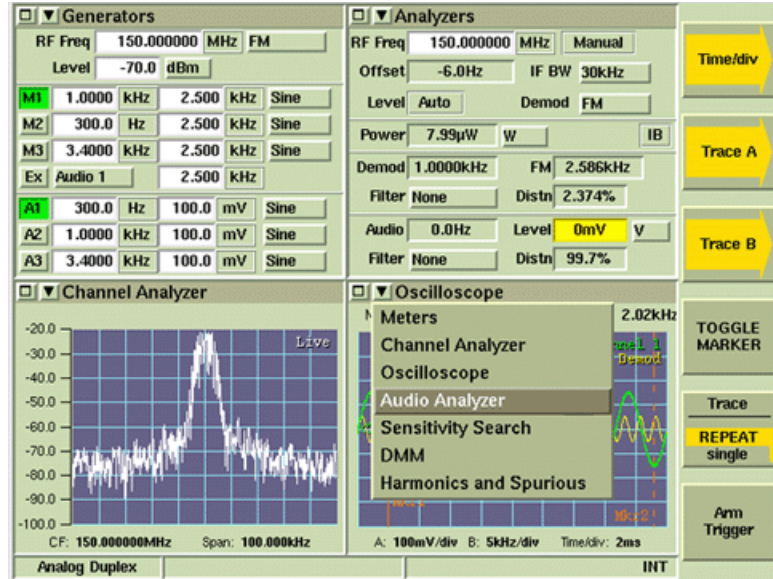

Fig. 8-1 Accessing Audio Analyzer

8.2.1.C Audio Analyzer Tile Layout

The Audio Analyzer can be viewed in minimized and maximized view. Soft Keys on the right side of the display provide access to settings not available on the main tile.

NOTE

Some of the images in this section show option enabled fields. These fields are not visible unless the applicable option is installed in the Test Set.

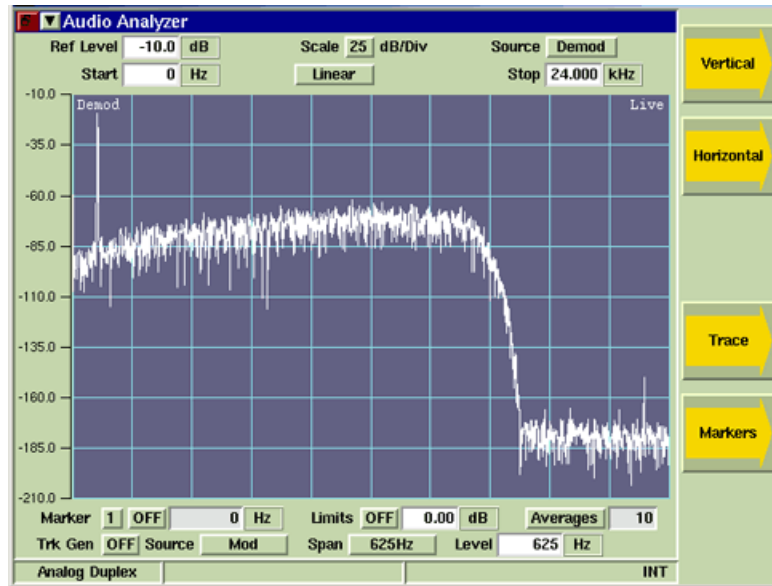

Fig. 8-2 Audio Analyzer Tile - Maximized View

8.2.1.D Field/Soft Key Definitions

8.2.1.D.1 Reference Level

The Reference Level sets the top value on the display graph. Power levels can be measured at any point on the trace in conjunction with the Scaling dB/div setting. The Reference Level can be set to any value within the specified range. The Reference Level is set by:

- Using the Expand and Contract Soft Keys to make step changes.
- Selecting the data field and using the Rotary Control Knob to adjust the level.
- Selecting the data field and using the Data Entry Input Keys to enter specific level.

8.2.1.D.2 Scaling dB

The Scaling drop-down menu selects from a range of 1, 2, 5, or 10. The scaling value (dB/div) can then be increased or decreased using the Expand or Contract Soft Keys.

8.2.1.D.3 Input Source

The Input Source drop-down menu selects Demod or Audio as the filtered signal source. When a filter is selected, the signal source is routed through the selected filter. Filter selection is made on the Analyzers Tile of the active operating Analog system. When the Tracking Generator is enabled, user defined filters are not available.

8.2.1.D.4 Start

Defines the start frequency of the frequency span. The maximum span is 0 to 24000 Hz; horizontal scale values must be within this range.

8.2.1.D.5 Stop

Defines the stop frequency of the frequency span. The maximum span is 0 to 24000 Hz; horizontal scale values must be within this range.

8.2.1.D.6 Linear/Log Scale Toggle Button

The Linear/Log toggle button changes the display between Linear and Logarithmic scaling.

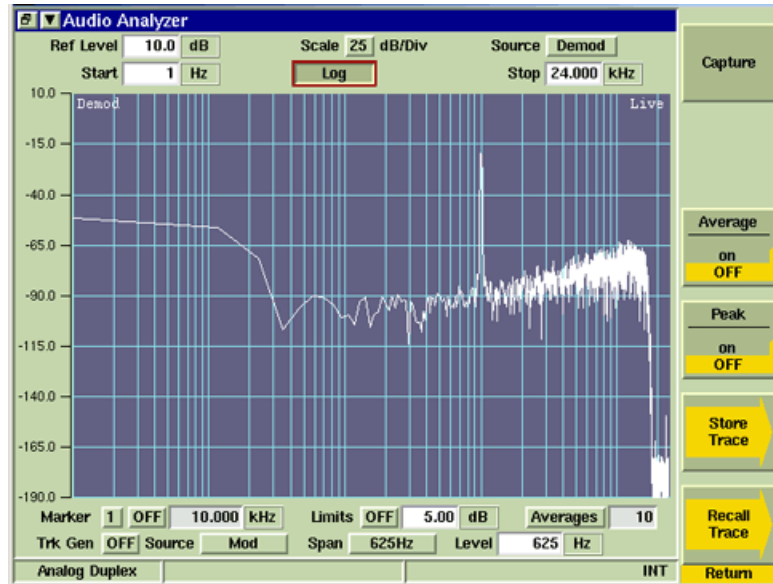

Fig. 8-3 Log Scaling Selected

8.2.1.D.7 Averages

The Averages toggle button Enables/Disables Average measurements. The Averages field defines the number of signal traces used to calculate average measurements. Refer to Trace Soft Key for additional information on Average measurements.

8.2.1.D.8 Vertical Soft Key

The Vertical Soft Key accesses scaling and positioning controls that adjust the trace's position on the display. The signal trace can also be adjusted by changing the Reference Level or Scaling dB values.

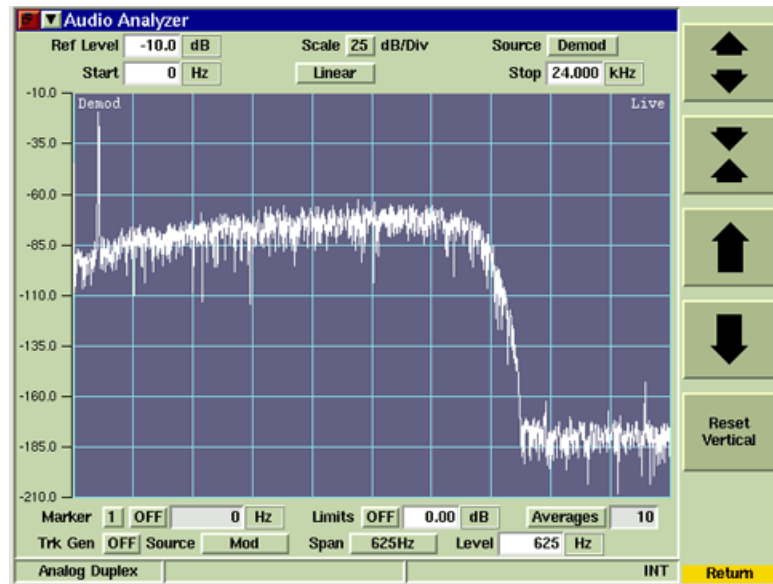

Fig. 8-4 Audio Analyzer - Ref Level and Scale Settings

8.2.1.D.9 Reset Vertical Soft Key

Resets vertical setting to position trace vertically in the center of the graph field.

8.2.1.D.10 Horizontal Soft Key

The Horizontal Soft Key accesses a group of soft keys that adjust the horizontal scaling and position of the signal on the graph field.

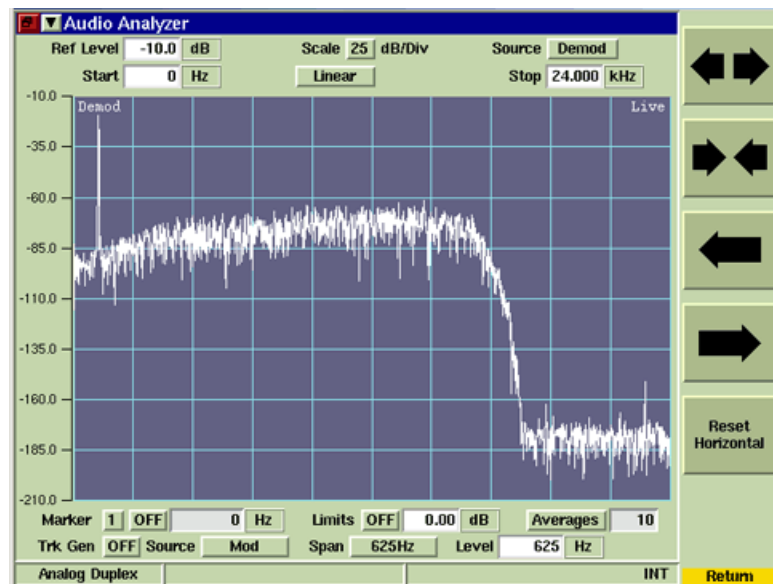

Fig. 8-5 Audio Analyzer Start and Stop Frequency Setting

8.2.1.D.11 Reset Horizontal Soft Key

Resets Start and Stop frequency values to frequency range of Test Set.

8.2.1.D.12 Markers Soft Key

Marker functionality is described in the section titled Markers, in Chapter 6, Radio Test Instruments.

8.2.1.D.13 Toggle Marker Soft Key

Refer to section titled Toggle Marker Soft Key in Chapter 6, Radio Test Instruments.

Marker functionality is described in the section titled Markers, in Chapter 6, Radio Test Instruments.

8.2.1.D.14 Trace Soft Key

The Trace Soft Key accesses trace display control functions to allow users to obtain average and peak measurements and to capture traces being displayed on the plot field.

Trace Color

Trace types being displayed on the graph are listed in the upper right corner of the graph field. The traces are color-coded to identify trace types.

- Live traces are White.
- Peak hold traces are Red.
- Averaged traces are Yellow.
- Captured traces are Green.

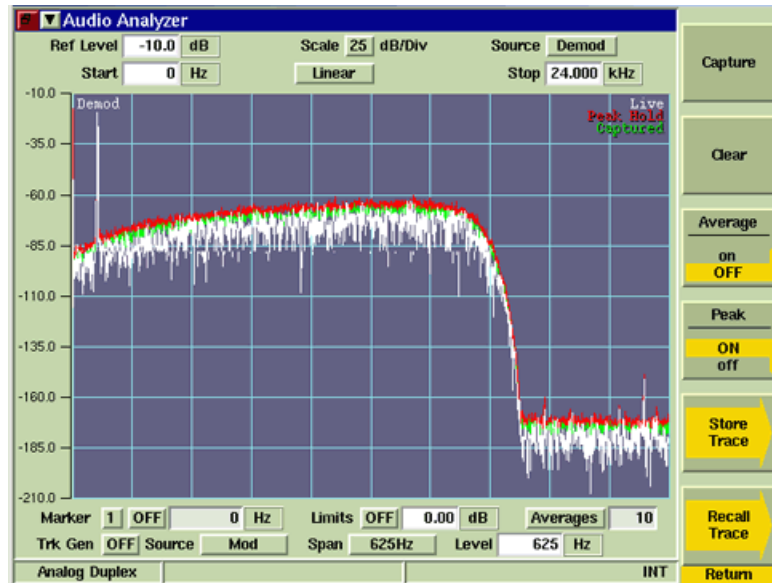

Fig. 8-6 Audio Analyzer Trace Soft Keys

8.2.1.D.15 Capture Soft Key

When Capture Soft Key is pressed the current trace is held on the display. To resume normal sweep operation press the Clear Soft Key.

A captured trace can be saved by pressing the HOLD Key, then selecting the Save As Soft Key.

8.2.1.D.16 Clear Soft Key

Clears the current captured trace and resumes display of Live trace. This soft key is only visible when a trace is in 'Captured' state.

8.2.1.D.17 Peak Hold Soft Key

When Peak Hold ON is selected, the maximum value at each frequency point is displayed to produce the RED Max Hold trace. This trace is cleared by selecting Peak Hold OFF. Peak Hold must be reset (toggled ON/OFF) when Average readings are Enabled/ Disabled. The white Live trace is also displayed and can be averaged depending on the current setting. This soft key is accessed by pressing the Trace Soft Key.

8.2.1.D.18 Average Soft Key

When the Average Soft Key is ON, the trace is calculated by averaging the number of measurements defined in the Averages field. The calculated value is a rolling average or a one-shot average as defined on the Trigger Tile using the Repeat Soft Key and Single Soft Key. A yellow progress indicator is displayed in the upper right corner of the graph field while the average reading is accumulating. This soft key is accessed by pressing the Trace Soft Key.

8.2.1.D.19 Store Trace Soft Key

The Store Trace Soft Keys opens a dialog box that allows a user to save a captured signal trace. The signal must be in "Captured" state before it can be saved using the Store Trace function. Refer to the Capture Soft Key for information on capturing a signal trace.

8.2.1.D.20 Recall Trace Soft Key

The Recall Trace Soft Key opens a dialog box that allows the user to load stored trace data.

8.2.1.E Audio Analyzer Trace Limits

Audio Analyzer Trace limits allows users to set visual limits above and below the desired target level. This function allows the user to quickly determine if the signal received from the UUT falls within a desired target level range.

8.2.1.E.1 Limits On/Off Toggle Button

The Limits On/Off Toggle Button enables the Audio Analyzer upper and lower signal trace limits.

8.2.1.E.2 Limits Value

Limit trace position is defined by entering a value in the Limits Value field. Upper and lower limit traces are offset from the signal by the value defined in the Limits Value field. For example, if the Limit Value is set to 5.0 dB, the Upper Trace is positioned 5.0 dB above the signal and the Lower Trace is positioned 5.0 dB below the signal.

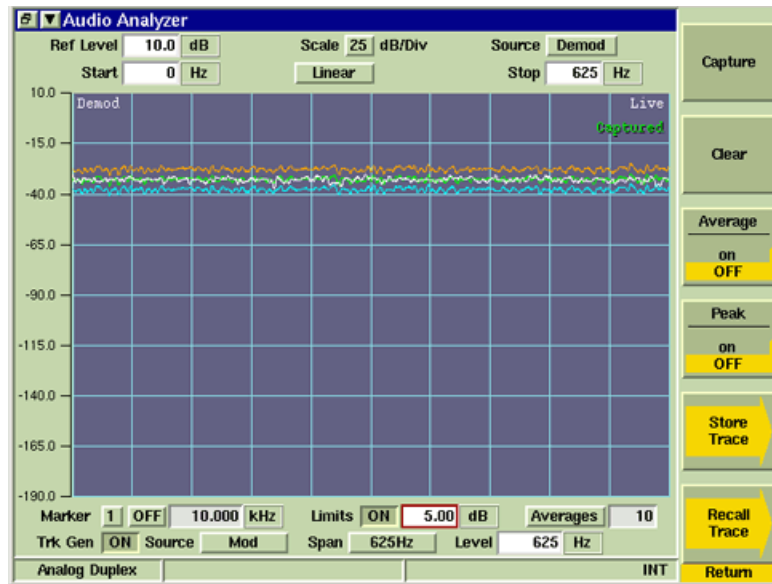

Fig. 8-7 Audio Analyzer - Trace Limits Enabled

8.2.1.E.3 Using Stored Trace with Trace Limits

The Store Trace function can be used in combination with Trace Limits to evaluate multiple radios that operate within the same specifications. To configure the Test Set for Audio Limits Analysis:

STEP

PROCEDURE

1. Capture and Store a baseline signal trace.
2. Define the Limits Value and set Limits to ON to establish a target upper and lower limit.
3. Press the Clear Soft Key to remove the stored signal trace (upper and lower Limits remain).
4. Transmit signal from UUT to Test Set. Adjust UUT until signal is within defined trace limits of baseline signal trace.

8.2.2. Simulcast Analysis (390XOPT210)

The Simulcast Analysis Option (390XOPT210) enables Tracking Generator functionality on the Audio Analyzer. The Audio Tracking Generator plots the frequency response of the external audio or demod audio path. The Simulcast Analysis Option can be used to evaluate pre-emphasis and de-emphasis curves of the transmit and receive audio paths. The examples below show the Simulcast Analysis Option being used to test a radio's receive frequency response (de-emphasis curve) and transmit frequency response (pre-emphasis curve). Both examples show Markers 1 and 2 enabled and positioned at 1000 Hz and 2000 Hz in order to evaluate signal strength at these points on the signal. Both examples show an approximate 6 dB variance in signal strength between 1000 Hz and 2000 Hz.



Fig. 8-8 Audio Analyzer - Rx Bandpass Sweep

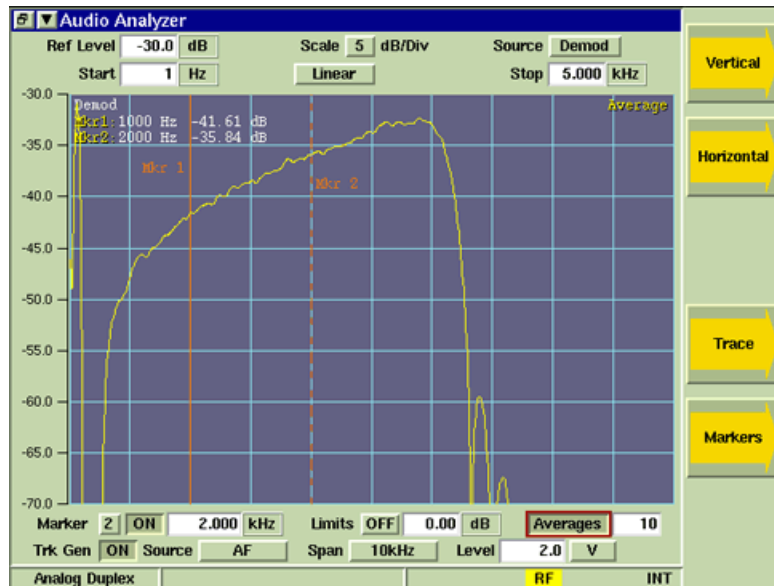

Fig. 8-9 Audio Analyzer - Tx Bandpass Sweep

8.2.2.A Trk Gen Toggle Button

The Trk Gen Toggle Button turns the Tracking Generator On and Off. When the Tracking Generator is ON, either the M1 or A1 Generator is used to produce the Tracking Generator Output signal. When the Tracking Generator Output Source is set to Mod, M1 is used to generate the Tracking Generator Output signal. When the Tracking Generator Output Source is set to AF, A1 is used to generate the Tracking Generator Output signal. If A1 or M1 is already enabled, the Tracking Generator signal overrides the signal currently configured on these generators.

8.2.2.B Span Drop-Down Menu

The Span drop-down menu is enabled when the Simulcast Analysis Option (390XOPT210) is installed in the Test Set. Span selects the horizontal scaling of the plotted signal. Once Span is selected, the Stop Frequency Field can be used to focus on a specific section of the signal. For example, Span can be set to 9.6 kHz, then the Stop Frequency can be adjusted to 100.0 Hz. The maximum Stop Frequency is defined by the Span value.

8.2.2.C Tracking Generator Source

The Tracking Generator Source drop-down menu selects the output source of the Tracking Generator signal.

When AF is selected, the Tracking Generator Output signal is routed to the Test Set's Fctn GEN/Demod Out Connector.

When MOD is selected, the Tracking Generator Output signal is routed through the modulator to the selected RF Out Connector (GEN or T/R).

8.2.2.D Tracking Generator Level

The Tracking Generator Level defines the Tracking Generator Output signal level.

8.2.3. Spectrum Analyzer Tracking Generator Option (390XOPT061)

The Tracking Generator Option (390XOPT061) generates a carrier wave that sweeps synchronously with the Spectrum Analyzer RF Receiver. The carrier wave can be applied to components or systems, and the output analyzed to display the frequency response of the device under test.

The Trk Gen drop-down menu Enables the Tracking Generator when Gen or TR is selected. Selecting OFF from this drop-down menu disables the Tracking Generator.

NOTE

Switching between Spectrum Analyzer and Test Mode disables the Tracking Generator.

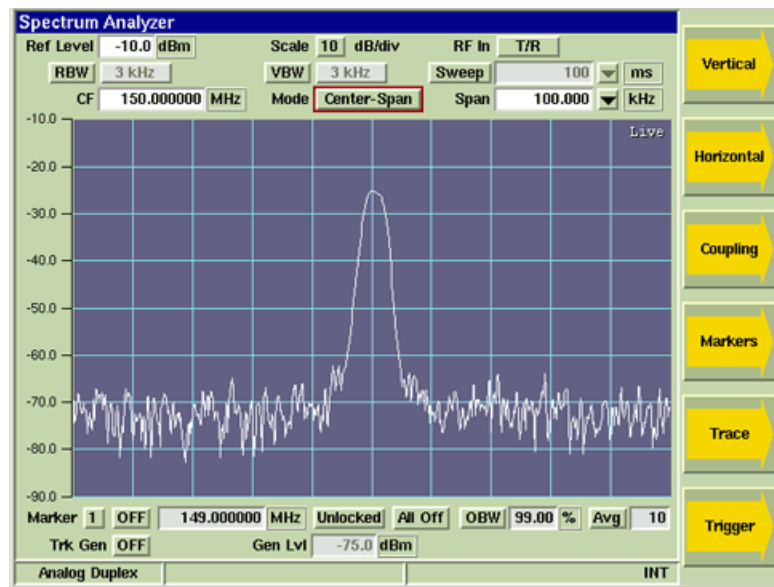

Fig. 8-10 Spectrum Analyzer Tile - Tracking Generator Parameters

8.2.3.A Field Definitions

8.2.3.A.1 Trk Gen Menu

The Trk Gen drop-down menu Enables the Tracking Generator when Gen or TR is selected. Selecting OFF from this drop-down menu disables the Tracking Generator.

8.2.3.A.2 Gen Lvl

The Gen Lvl Field provides quick access to set the Generator power level. This field is only available on the Spectrum Analyzer Tile when the Tracking Generator Option (390XOPT061) is installed in the Test Set.

8.2.4. Analyzer OBW & Power Between Markers Option (390XOPT064)

The Analyzer Occupied Bandwidth (OBW) and Power Between Marker Option provides the user with added features for evaluating the power of a received signal. The Power Between Markers function allows the user to evaluate the total power level of a received signal between Marker 1 and Marker 2 on the Channel Analyzer and Spectrum Analyzer. The Power Measurement (Pwr:) is displayed under the Delta Measurement when Marker 1 and Marker 2 are enabled.

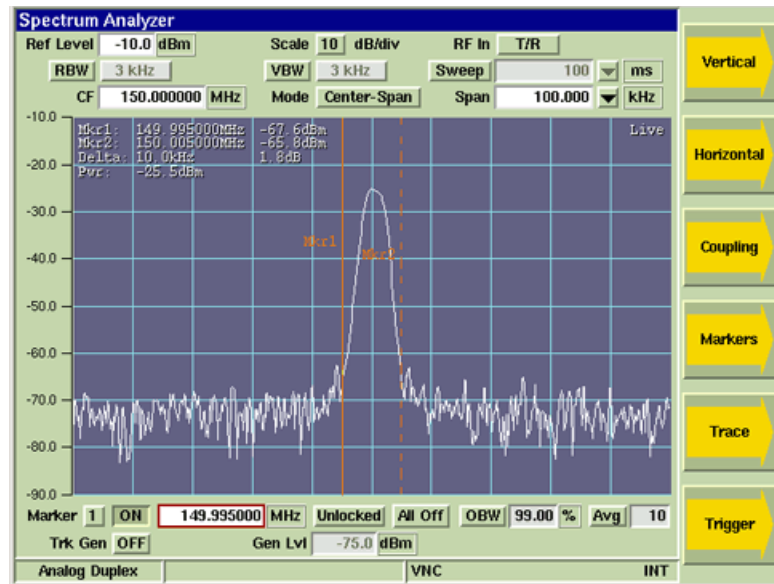

Fig. 8-11 Spectrum Analyzer - Power Between Markers Measurement

The Occupied Bandwidth (OBW) Function measures the frequency band that contains a specified percentage of total signal power, centered on the assigned Center Frequency (CF). The OBW function is enabled/disabled by pressing the OBW Toggle Button. When enabled, the OBW Power and Bandwidth measurements are displayed on the Analyzer graph.

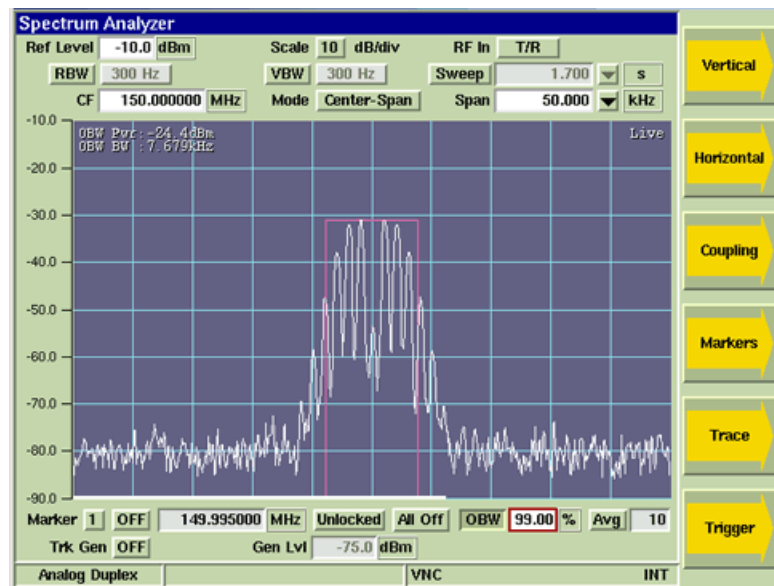

Fig. 8-12 Spectrum Analyzer - Occupied Bandwidth at 99%

8.2.4.A Field Definitions

8.2.4.A.1 OBW Field

The OBW field defines the percentage of a signal's power over which Occupied Bandwidth measurements are performed.

8.2.4.A.2 OBW Pwr

The OBW Power measurement indicates the power level of the signal across the Occupied Bandwidth.

8.2.4.A.3 OBW BW

The OBW Bandwidth measurement indicates the amount of Bandwidth occupied by the percentage of signal power as defined by the OBW field.

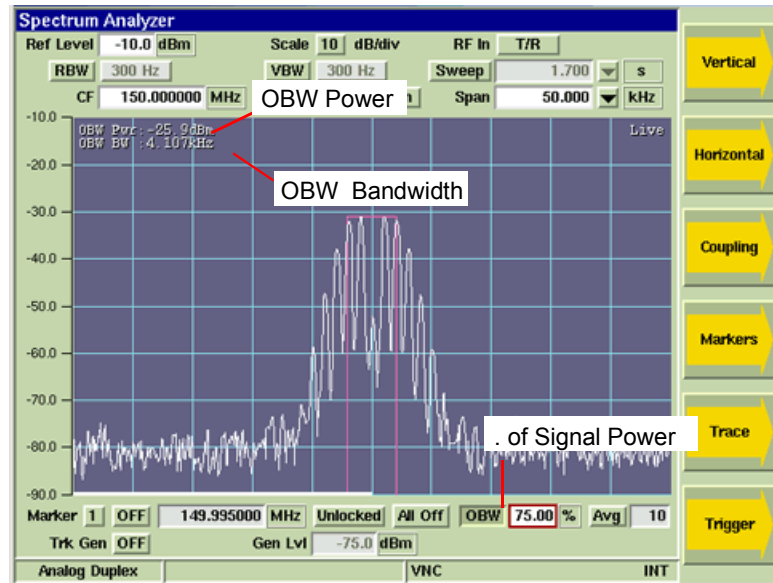

Fig. 8-13 Spectrum Analyzer - Occupied Bandwidth at 75%

8.3 OPTIONAL TEST AND MEASUREMENT FUNCTIONS

8.3.1. Harmonics and Spurious Measurements (390XOPT060)

The Harmonics and Spurious Measurements Option (390XOPT060) provides users with the ability to examine incremental readings at the 2nd and 3rd harmonics at a specified frequency and to obtain readings at the highest non-harmonic frequency spike over a defined frequency range. The Harmonics and Spurious Measurements and Configuration Tiles are only available when the Harmonics and Spurious Test Option (390XOPT060) is installed in the Test Set.

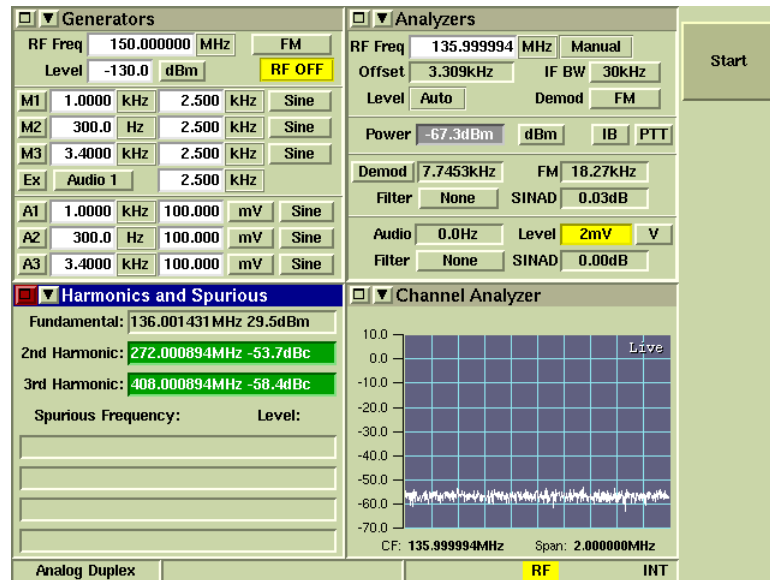

Fig. 8-14 Harmonics and Spurious Measurements Tile

8.3.1.A Field/Soft Key Definitions

8.3.1.A.1 Fundamental Frequency

Indicates the frequency at which Harmonic measurements are obtained.

8.3.1.A.2 Fundamental Level

Indicates the unit of measurement for Harmonic measurements.

8.3.1.A.3 Second Harmonic Level

Indicates reading at second harmonic level.

8.3.1.A.4 Third Harmonic Level

Indicates reading at third harmonic level.

8.3.1.A.5 Start Soft Key

Initiates harmonics and spurious measurement sweeps.

8.3.1.A.6 Spurious Measurements Field

Results area displays frequency at which non-harmonic frequency spikes are detected and the power level at that frequency. These fields are blank when no spurious measurements are detected above the Spurious Threshold level defined on the Harmonics and Spurious Configuration Tile.

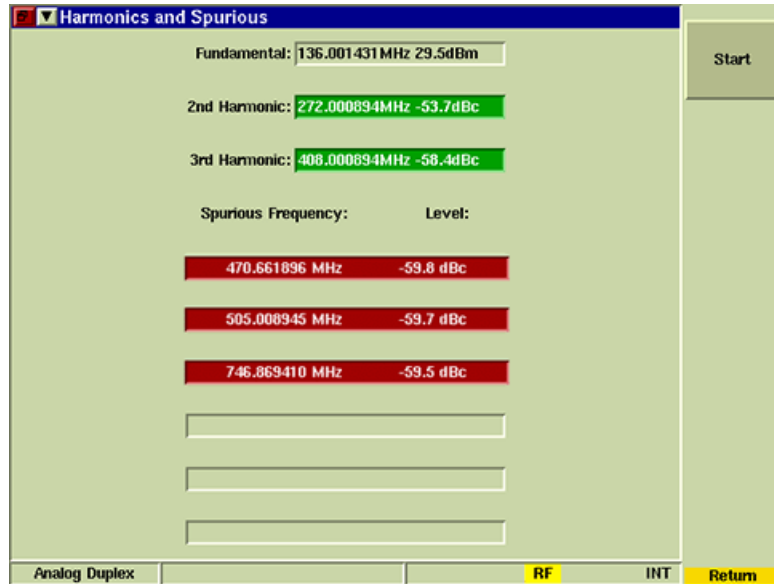

Fig. 8-15 Harmonics and Spurious Results

8.3.2. Harmonics and Spurious Configuration Tile

The Harmonics and Spurious Configuration Tile sets sweep and Pass/Fail parameters for harmonics and spurious measurements. This tile is only available when the Harmonics & Spurious Test Option (390XOPT060) is installed in the Test Set.

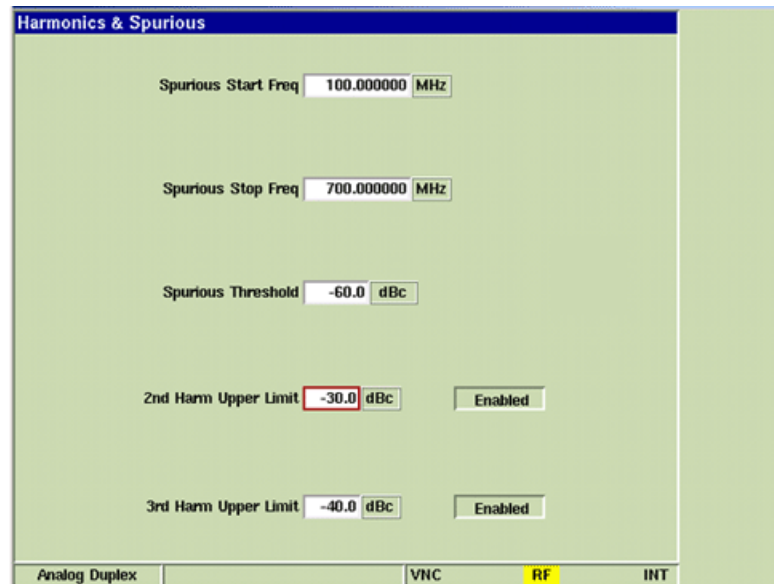

Fig. 8-16 Harm & Spur Limits Configuration Tile

8.3.2.A Field Definitions

8.3.2.A.1 Spurious Start Freq

The Spurious Start field sets the lower frequency at which Spurious measurement sweeps begin.

8.3.2.A.2 Spurious Stop Freq

The Spurious Stop field sets the upper frequency at which Spurious measurement sweeps stop.

8.3.2.A.3 Spurious Threshold Level

The Spurious Threshold field sets the level at which Spurious measurements are triggered. The Test Set records measurements of frequency spikes that exceed the defined threshold level.

8.3.2.A.4 2nd Harmonic Upper Limit

The 2nd Harmonic Upper Limits field sets upper limit value for 2nd Harmonic measurements.

8.3.2.A.5 3rd Harmonic Upper Limit

The 3rd Harmonic Upper Limit field sets upper limit value for 3rd Harmonic measurements.

8.3.2.A.6 Enabled/Disabled

The Enable/Disable Toggle button turns defined limits on and off. Default values are applied if values are not defined by user.

8.3.3. IQ Gen Modulation (390XOPT054)

IQ Gen (Generator) Modulation is an optional feature for the 3900 Series (390XOPT054) that allows users to download IQCreator waveform files to the 3900. This option only supports waveform files that have been created using IQCreator software. Refer to the IQCreator Getting Started Guide which is included on this CD for information on using IQCreator.

8.3.3.A Preliminary Procedures

IQCreator waveform files must be imported to the Test Set via the File Management Utility function prior to using the IQ Gen option.

8.3.3.B Accessing IQ Gen

The Analog Duplex System must be operating on the 3900 to utilize the IQ Gen. To select IQ Gen Modulation file:

- | STEP | PROCEDURE |
|------|---|
| 1. | Press the CONFIG Key twice to open the CONFIG Menu. |
| 2. | Select IQ Gen from the CONFIG floating menu. |
| 3. | Select the desired IQ File from the IQ File drop-down menu. After the file is selected, data fields on the IQ Gen Configuration Tile are filled with IQ File data information (refer to second example screen below). |

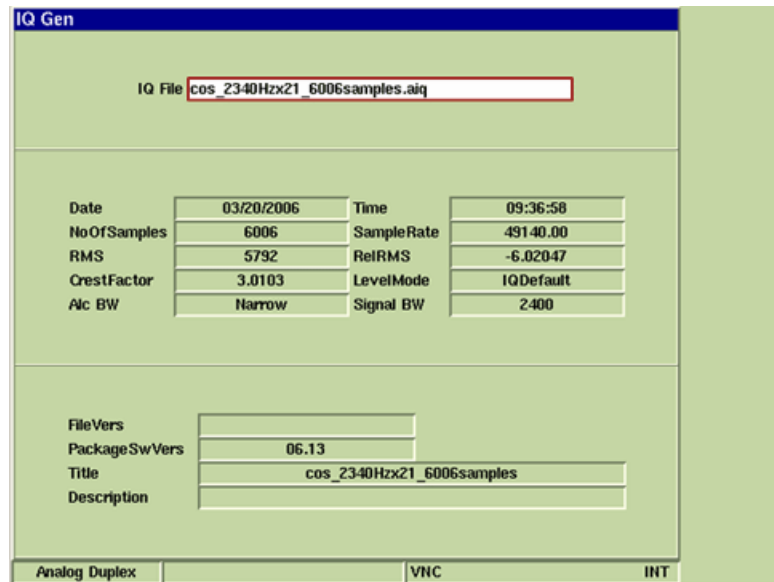

Fig. 8-17 IQ Gen Configuration Tile - File Data

- Press TEST Key to return to the Analog Duplex Test Tiles.

STEP

PROCEDURE

- Select IQ Gen from the Modulation drop-down menu on the Generators Tile. The Test Set now displays the selected IQ file.

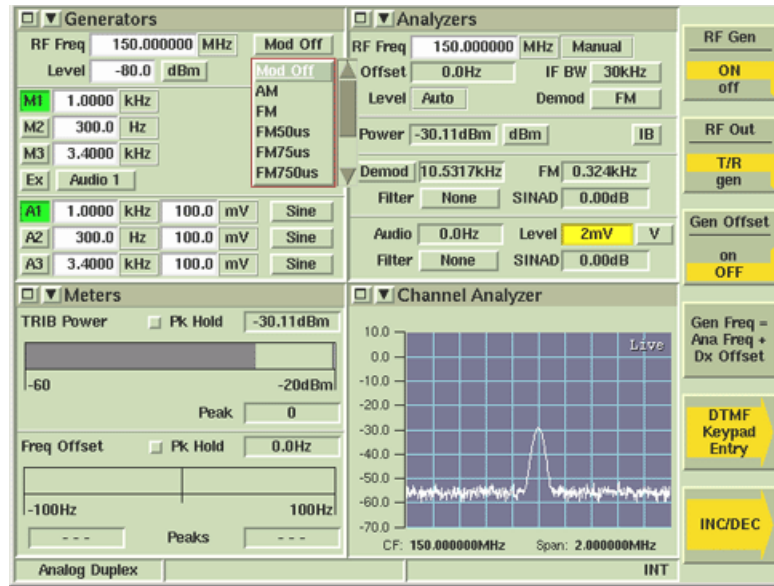

Fig. 8-18 IQ Gen Selection

8.3.4. Site Monitoring Application Test Option (390XOPT051)

The Sensitivity Search Tile is enabled when the Site Monitoring Application Test Option (390XOPT051) is installed in the Test Set. The Sensitivity Search Tile is used to log the Sinad measurement of an injected signal over time. Sensitivity Search is also used to log the spectrum trace of the RF signal. Sensitivity Search data files are referred to throughout this section as Data Log Files.

Refer to Application Note 46891/951, Using the VIAVI 3900 Series for Remote Site Monitoring, for additional information on use of this option.

8.3.4.A Accessing Site Monitoring

The Sensitivity Search Tile is selected from the Measurement drop-down menu on any of the Analog Duplex Test Tiles. This Tile is only available when the Site Monitoring Application is installed in the Test Set.

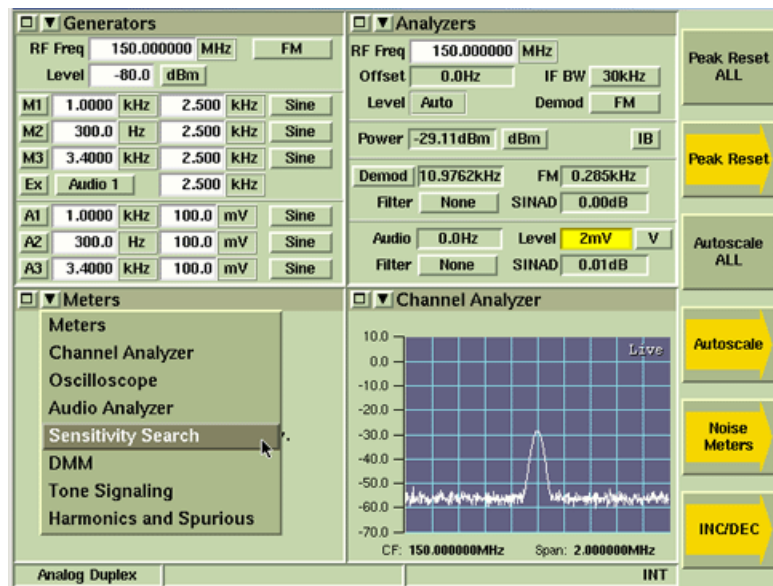

Fig. 8-19 Selecting Sensitivity Search Tile



Fig. 8-20 Main Sensitivity Search Tile - Maximized View

8.3.4.B Field/Soft Key Definitions

The Sensitivity Search Test Tile contains parameters that must be defined to perform a Site Monitoring test.

8.3.4.B.1 Sinad

Sets the reference point from which all readings are taken.

8.3.4.B.2 Interval

Defines how frequently readings are logged to the file for the duration of the search.

8.3.4.B.3 Average

Defines the number of readings to be averaged to calculate measurements.

8.3.4.B.4 Duration

Defines the length of time over which readings are taken.

8.3.4.B.5 Filter

Selects a measurement filter to include in the measurement path.

8.3.4.B.6 Source

Selects signal source of input signal.

8.3.4.B.7 File Name

Indicates the Data Log File currently running or being displayed on Sensitivity Search Tiles. The File name is limited to 18 characters and can not contain any blank spaces. The Test Set logs data to the last selected Data Log File until a new file name is assigned.

8.3.4.B.8 Logging Start/Stop Soft Key

Starts and stops logging data. When Status is Running, the Sensitivity Search Tile appears as shown in example below. When logging is complete, display Tile defaults back to Main Sensitivity Search Tile.

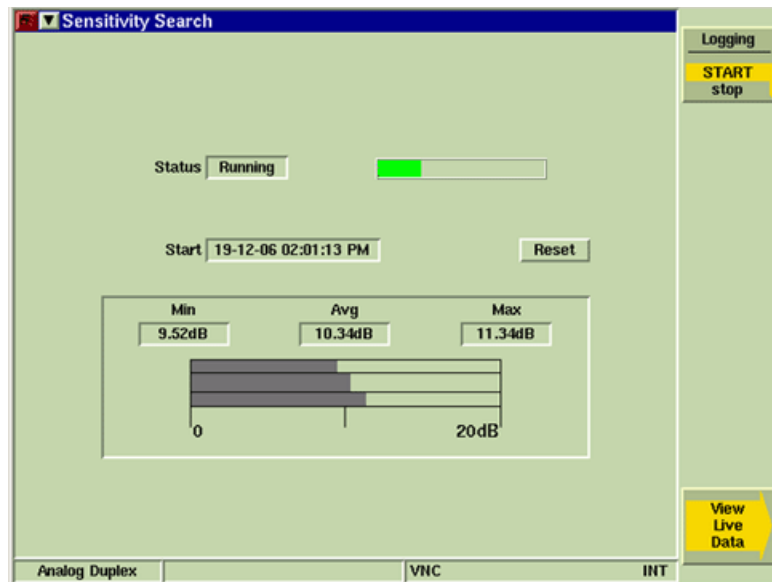

Fig. 8-21 Sensitivity Search Tile - Log Running

8.3.4.B.9 View Live Data Soft Key

Opens soft key sub-menu that allows user to view data as if it acquired. This soft key is only available while data is being logged (Status field indicates Running).

8.3.4.B.10 Logging Soft Key

Displays log file as data is acquired. This soft key is accessed by pressing the View Live Data Soft Key while Data Log is running.

8.3.4.B.11 Plot Soft Key

Displays graph plot of data as it is acquired. This soft key is accessed by pressing the View Live Data Soft Key while data is being logged.

8.3.4.B.12 Spectrum Soft Key

Displays Spectrum Analyzer plot of data as it is acquired. This soft key is only available while data is being logged.

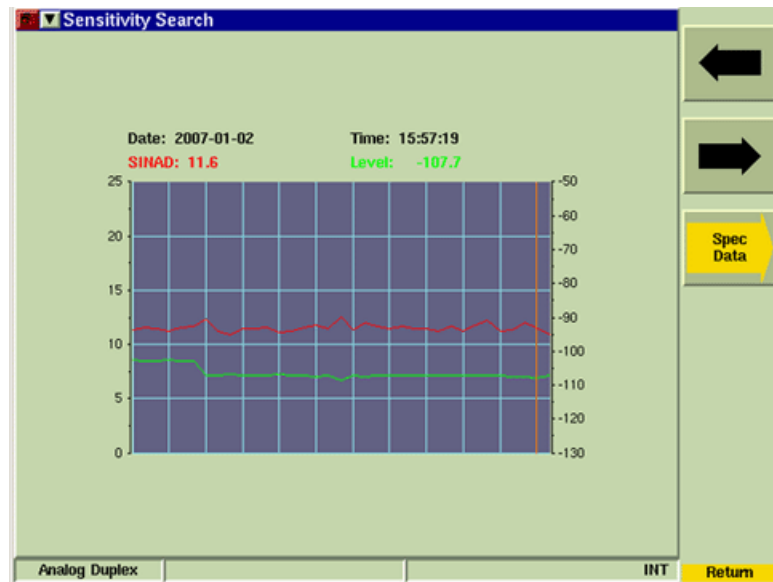

Fig. 8-22 View Live Data Soft Key Sub-menu

8.3.4.B.13 Default Soft Key

Displays Main Sensitivity Search Tile.

8.3.4.B.14 View Post Data Soft Key

Opens soft key sub-menu that allows user to review saved Data Log Files. This soft key is only available after data acquisition has stopped.

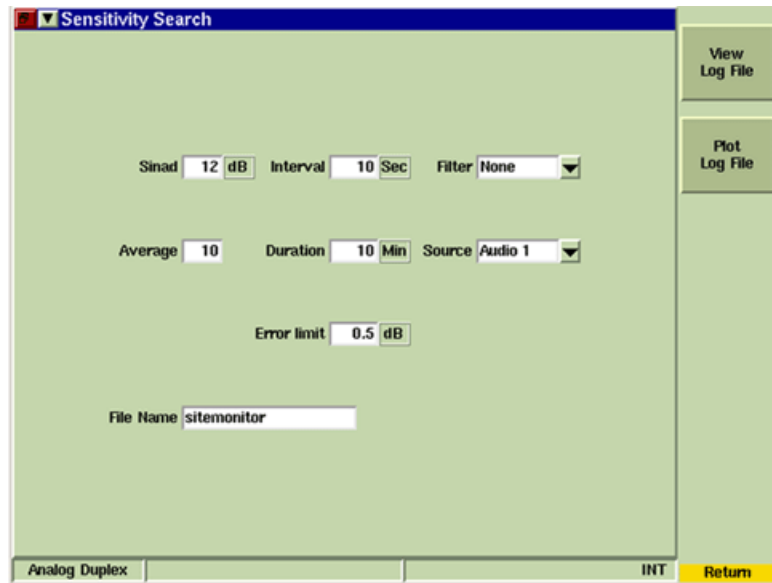

Fig. 8-23 Sensitivity Search - View/Post Data Tile

8.3.4.B.15 Calibration Soft Key

Initiates Sensitivity Search Calibration function. Unit under test must be configured and connected to Test Set prior to running calibration.

8.3.4.B.16 Spec Data Soft Key

Displays logged data on a Spectrum Analyzer plot field. Data can be viewed while data is being logged and after logging stops.

8.3.4.B.17 File Manager Soft Key

Opens a soft key sub-menu that allows user to navigate between or delete existing Data Log Files.

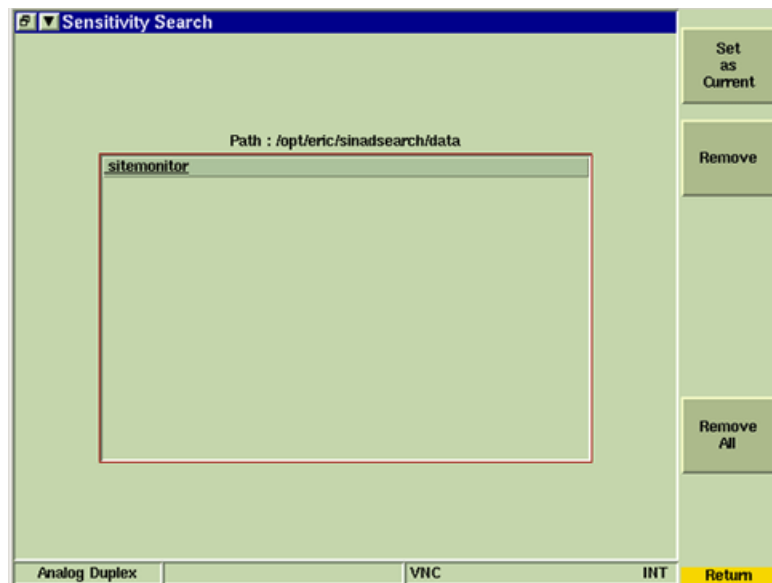

Fig. 8-24 Sensitivity Search - File Manager Tile

8.3.4.B.18 View Log File Soft Key

Displays list of Data Log Files. Data Log Files include date and time of test, the Sinad reading and Power Level readings at each recorded interval. The View Log Soft Key is accessed by pressing the View Post Data Soft Key after data logging has stopped. Scroll Up and Scroll Down Soft Keys navigate through the data log when Mouse option is not being used.

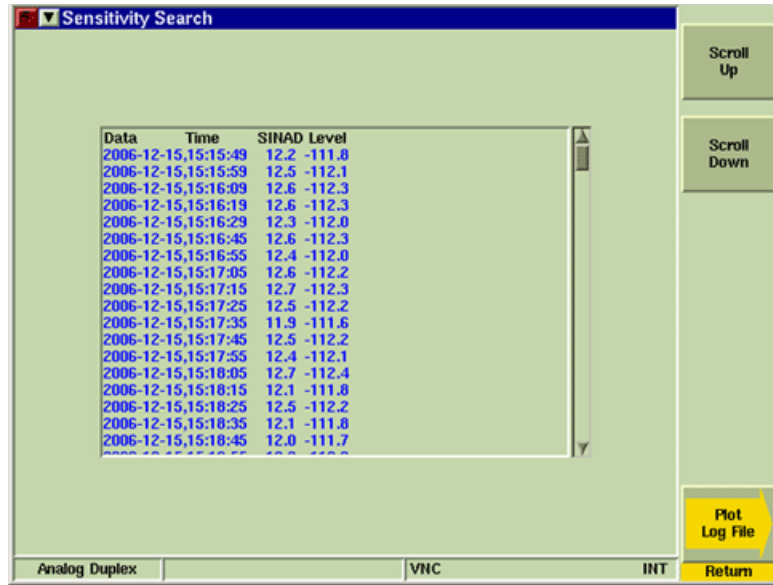

Fig. 8-25 Logged Data File

8.3.4.B.19 Plot Log File Soft Key

Displays logged data on a graph plot. Directional arrow soft keys allow user to navigate to points along the acquired signal.

8.3.4.B.20 Spec Data Soft Key

Displays logged data on a Spectrum Analyzer plot field. Data can be viewed while data is being logged and after logging stops.

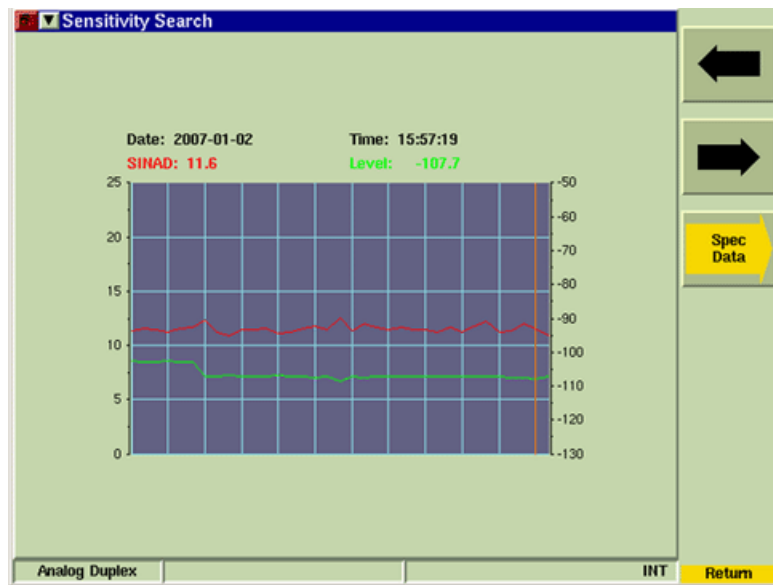

Fig. 8-26 Logged Data - Plot Log Soft Key Sub-menu

8.3.4.C Managing Log Files

8.3.4.C.1 Open Existing Log File

STEP	PROCEDURE
------	-----------

1. Press File Manager Soft Key.
2. Select the desired file name from list.
3. Press Set as Current Soft Key.

8.3.4.C.2 To add to an existing Data Log File:

STEP	PROCEDURE
------	-----------

1. Press File Manager Soft Key.
2. Select desired Data Log File from list and press Set as Current Soft Key.
3. Press Return, then Logging Soft Key to start logging data to the selected Data Log File.

8.3.4.C.3 To Create New Data Log File

STEP	PROCEDURE
------	-----------

1. Select File Name field on main Sensitivity Search Tile.
2. Enter desired file name in field.
3. Data is automatically saved under designated file name when Logging Soft Key is pressed.

8.3.4.C.4 Delete Log File

STEP	PROCEDURE
------	-----------

1. Press File Manager Soft Key.
2. Select the desired file name from list.
3. Press Remove Soft Key to remove selected Data Log File or press Remove All Soft Key to delete all Data Log Files.

8.3.5. POCSAG Testing Option (390XOPT067) - Encoding

The POCSAG Testing Option (390XOPT067) provides users with the ability to test a pager's transmit and receive operation.

The POCSAG Encoding Tile is used to test a pager's receive performance. The POCSAG Encoding Tile is used to define the parameters of the encoded message being sent to the pager. Message parameters should be defined according to the pager's operational capabilities. The POCSAG Decoding Tile is used to display the decoded POCSAG signal received from the pager.

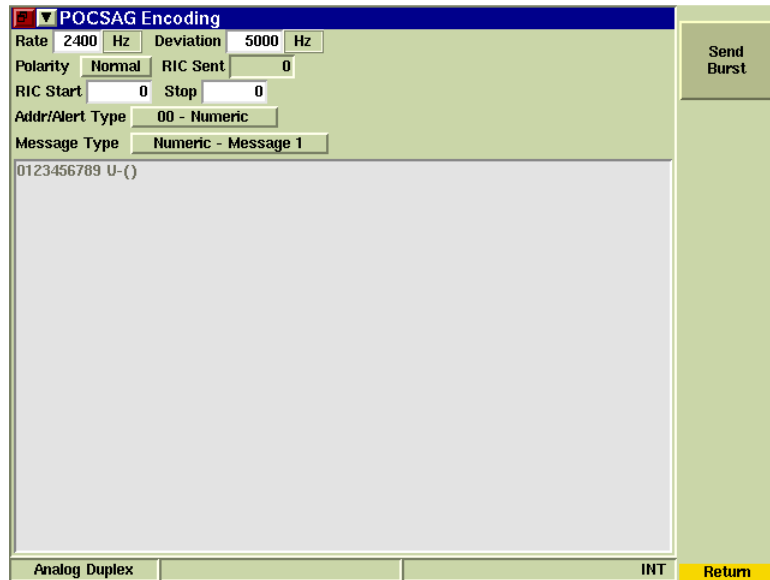

Fig. 8-27 POCSAG Encoding Tile

8.3.5.A Field/Soft Key Definitions

8.3.5.A.1 Rate

Defines the bit rate at which the message is sent.

8.3.5.A.2 Deviation

Defines the deviation at which the message is sent.

8.3.5.A.3 Polarity

Defines the polarity of the message to be sent.

8.3.5.A.4 RIC (Radio Identity Code) Sent

Indicates the pager to which the last message was sent. This is a read only field.

8.3.5.A.5 RIC Start/Stop Fields

The RIC Start and Stop fields define the range of RICs to which a message is sent. The RIC Start number and RIC Stop number can be set to the same value. When the Start and Stop RIC fields are set to the same number the message is sent only to that RIC.

When the RIC Stop number is set lower than the RIC Start number, the POCSAG Message is sent to the radios included in the Start/Stop range in reverse numerical order. For example, if the RIC Start number is 500 and the RIC Stop number is 400, the message is sent starting with RIC 500, then 499, 498 and so on until the message is sent to RIC 400.

8.3.5.A.6 Address/Alert Type

Defines the type of alert to be sent to the pager. This parameter is defined in POCSAG specifications as "Function Bits."

8.3.5.A.7 Message Type

Selects the type of message to be sent to the pager. Also defines the encoding for the message as determined by the selected Address/Alert Type.

Alert Only

Sends an audible alert tone; does not include a message.

Alphanumeric Custom

When Alphanumeric Custom is selected the message field updates to an edit state (refer to Fig. 8-28) which allows the user to define an alphanumeric message to send to the pager.

Alphanumeric Message

When any of the Alphanumeric Custom messages is selected the message field updates to display the corresponding pre-defined (canned) alphanumeric message which will be sent to the pager.

Alphanumeric RIC

Sends an alpha-numeric message which includes the RIC.

Numeric Custom

When Numeric Custom is selected the message field updates to an edit state (refer to Fig. 8-28) which allows the user to define a numeric message to send to the pager.

Numeric Message 1

Selects a pre-defined numeric message to send to the pager.

Numeric RIC

Sends a numeric message which includes the RIC.

POCSAG Encoding
Rate 2400 Hz Deviation 4500 Hz
Polarity Normal RIC Sent 0
RIC Start 0 Stop 0
Addr/Alert Type 11 - Alphanumeric
Message Type Alphanumeric - Message 1
Contact Aeroflex

Read Only State

POCSAG Encoding
Rate 2400 Hz Deviation 4500 Hz
Polarity Normal RIC Sent 0
RIC Start 0 Stop 0
Addr/Alert Type 11 - Alphanumeric
Message Type Alphanumeric - Custom
123-456-7890

Edit State

Fig. 8-28 POCSAG Message Field States

8.3.5.A.8 Send Burst Soft Key

The Send Burst Soft Key generates the defined POCSAG message. When the Send Burst Soft Key is pressed the fields on the POCSAG Encode Tile update to read only fields (Fig. 8-29) while the Test Set is in a transmit state.

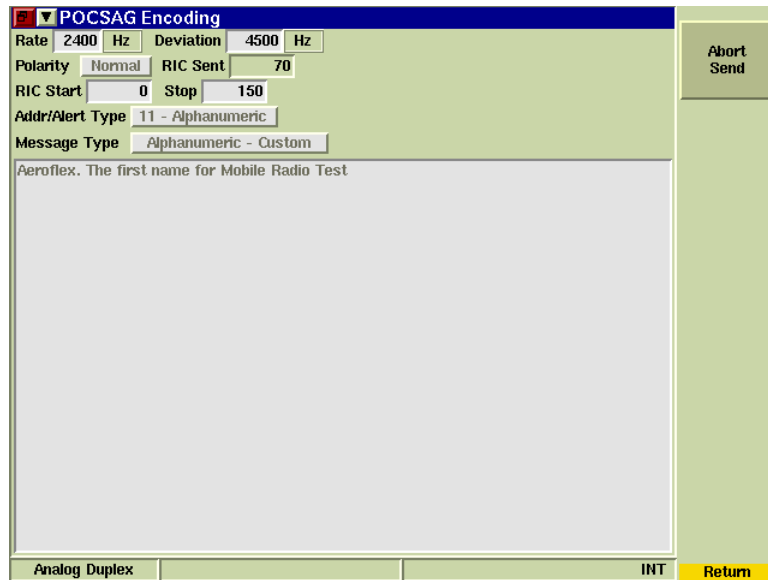

Fig. 8-29 POCSAG Encoding - Sending Message

8.3.5.A.9 Abort Soft Key

The Abort Soft Key is enabled while the Test Set is in the process of sending a message. Pressing the Abort Soft Key stops sending the encoded POCSAG message.

8.3.5.B How to Send an Encoded Message to Pager

To configure the Test Set to send an encoded message to a pager:

STEP

PROCEDURE

1. Configure the pager according to operating specifications (i.e., frequency, RIC, rate...).
2. Set Test Set's RF Generator Port to T/R. Connect an antenna to the Test Set's T/R Connector.
3. Set Test Set's RF Generator Frequency to the pager's frequency.
4. Configure the Test Set POCSAG Encoding parameters according to pager operational specifications.
5. Press the Send Soft Key on the POCSAG Encoding Tile.

8.3.6. POCSAG Testing Option (390XOPT067) - Decoding

The POCSAG Testing Option (390XOPT067) provides users with the ability to test a pager's transmit and receive operation.

The POCSAG Testing Option (390XOPT067) provides users with the ability to test a pager's transmit and receive operation. The POCSAG Decoding Tile displays the content of the decoded POCSAG signal. Tile parameters are used to configure the type of content decoded and displayed in the Logging field.

The POCSAG Encoding Tile is used to define outgoing encoded POCSAG messages.

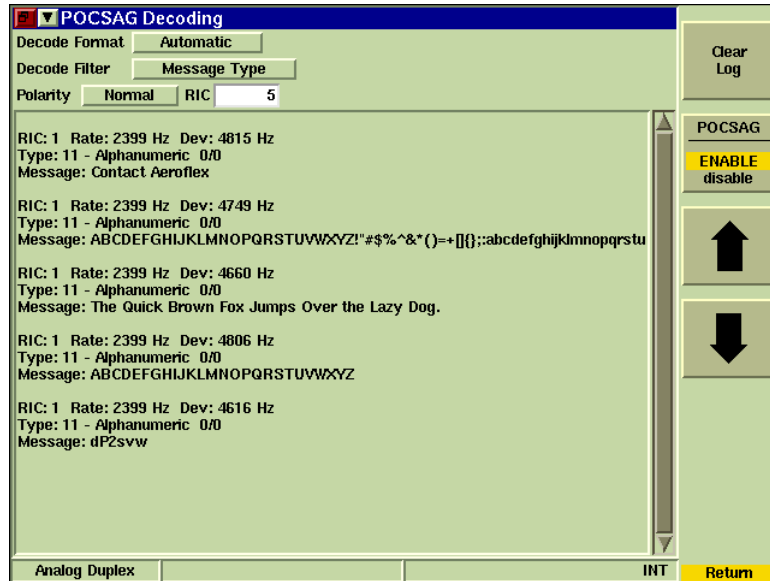

Fig. 8-30 POCSAG Decoding Tile

8.3.6.A Field/Soft Key Definitions

8.3.6.A.1 Decode Format

Selects the type of message encoding of the signal being sent to the Test Set. This field should be set according to the pager's operational capabilities.

Alphanumeric

Configures the Test Set to decode as alphanumeric signals.

Automatic

Configures the Test Set to detect the format and to decode the content of the incoming signal.

Numeric

Configures the Test Set to decode as numeric signals.

8.3.6.A.2 Decode Filter

Selects the type of data filtered from the received signal and displayed in the Log Field.

All

Displays all data received in the incoming POCSAG signal.

RIC

Displays pager only for the specified RIC.

Message Type

Displays messages defined by the Decode Format.

8.3.6.A.3 Polarity

Selects how the POCSAG signal is decoded (normal or inverted).

8.3.6.A.4 RIC

Decodes data from the incoming signal for the pager with the specified RIC when the Decode Filter is set to RIC.

8.3.6.A.5 Clear Log

Clears the Data Log field or all logged data.

8.3.6.A.6 POCSAG State

Enables the Test Set's to decode a POCSAG signal.

8.3.7. Selectivity Generator Tile

The Selectivity Generator Option (390XOPT083) provides users with the ability to evaluate the receive selectivity of a Unit Under Test (UUT). The Selectivity Generator Tile is only available when the Selectivity Generator Option (390XOPT083) is installed in the Test Set.

8.3.7.A Field/Soft Key Definitions

Fig. 8-32 illustrates how the fields on the Selectivity Generator Tile (Fig. 8-31) correspond to a waveform.

The screenshot shows the Selectivity Generator interface with the following fields and values:

RF Freq	149.986783	MHz
Level	-104.4	dBm
Center	150.000000	Mhz
High	150.013230	Mhz
Low	149.986783	Mhz
Delta	13.230	KHz
Total BW	26.447	KHz
Percent non symmetry	0.10	%

Buttons on the right side: Set Center Freq, Set Freq High, Set Freq Low, Reset.

Bottom status bar: Analog Duplex, AUT, AMP INT, Return.

Fig. 8-31 Selectivity Generator Tile

8.3.7.A.1 RF Freq

The RF Freq field sets the RF Output frequency of the Test Set RF Generator. Units of measure are GHz, MHz, kHz and Hz as defined by user.

8.3.7.A.2 Level

The Level field sets the RF Generator Output Level. The selected RF Output level is dependent on the RF Output port selected. The indicated RF output is modified if an RF Level Offset value is set. Units of measure are dBm, V and dBuV.

8.3.7.A.3 Set Center Frequency/Center Button

Pressing either the Set Center Freq or the Center Button populates the Center Frequency Field with the current RF Generator Frequency.

$$\text{center frequency} = \text{RF Generator Frequency (receiver operating frequency)}$$

8.3.7.A.4 Set High Frequency/High Button

Pressing either the Set High Freq or the High Button populates the High Frequency Field with the current RF Generator Frequency. The field does not update if the detected RF Generator Frequency is less than the Center Frequency.

$$\text{high frequency} = \text{upper range value of receiver operating frequency bandwidth}$$

8.3.7.A.5 (High) Delta

The High Delta field displays the difference between the High Frequency and the Center Frequency (high frequency - center frequency = high delta). This value is displayed in kHz.

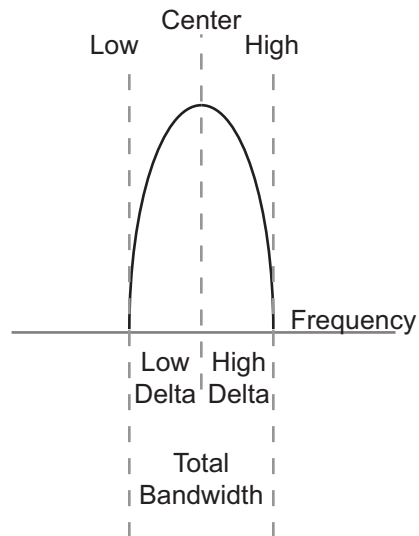

Fig. 8-32 Selectivity Generator - Illustrated Waveform

8.3.7.A.6 Set Low Frequency/Low Button

Pressing either the Set Low Freq or the Low Button populates the Low Frequency Field with the current RF Generator Frequency. The field does not update if the detected RF Generator Frequency is greater than or equal to the Center Frequency.

low frequency = lower range value of receiver operating frequency bandwidth

8.3.7.A.7 Low Delta From Center

The Low Delta field displays the difference between the Center Frequency and the Low Frequency (center frequency - low frequency = low delta). This value is displayed in kHz.

8.3.7.A.8 Total Bandwidth

The Total BW field displays the sum of the High Delta and Low Delta values (high delta + low delta = total bandwidth).

8.3.7.A.9 Percent Non-symmetry

The Percent Non-Symmetry field displays the variance between the High Delta and Low Delta in the form of a percent.

8.3.7.A.10 Reset Soft Key

Clears all fields on the tile.

8.3.7.B How to Use Selectivity Generator

This examples describes how to use the Selectivity Generator Tile to perform a typical sensitivity test. This example just one of the ways in which the Selectivity Generator can be used to measure receiver selectivity.

STEP	PROCEDURE
------	-----------

1. Configure hardware as shown in Fig. 8-33.

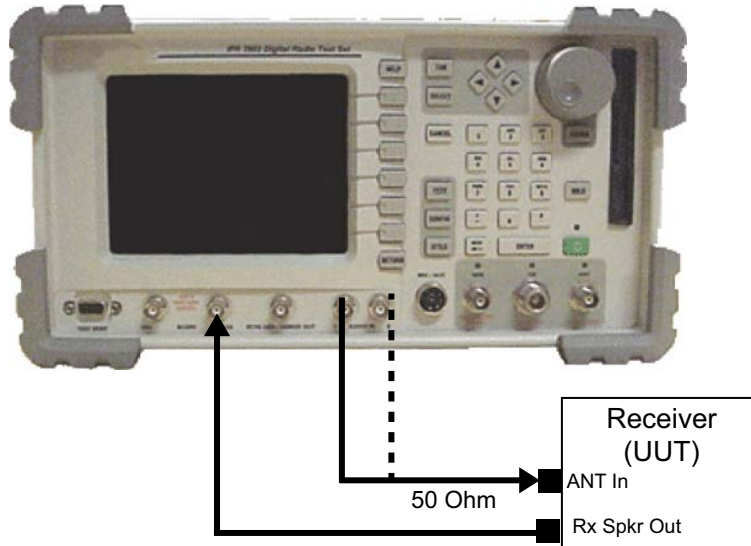

Fig. 8-33 Selectivity Generator Test Setup Diagram

2. Select the SINAD Meter on the Meters Tile (Noise Meters Soft Key on the Analyzers or Meters Tiles).
3. Set the Test Set's RF Generator Frequency to the Receiver's operating frequency.
4. Increase the Test Set's RF Generator Level until the measuring device displays the reference sensitivity (typically +12 dB SINAD).
5. Press the Set Center Freq or Center Button on the Selectivity Generator Tile.
6. Increase the RF Generator Level by +6 dB.
7. Increase the RF Generator Frequency until the measuring device displays the reference sensitivity (typically +12 dB SINAD).
8. Press the Set High Freq or High Button on the Selectivity Generator Tile.
9. Decrease the RF Generator Frequency until the measuring device displays the reference sensitivity (typically +12 dB SINAD).
10. Press the Set Low Freq or Low Button on the Selectivity Generator Tile.

THIS PAGE INTENTIONALLY LEFT BLANK.

Chapter 9 - 3900 Optional Test Scripts

9.1 INTRODUCTION

This chapter describes the optional test scripts available for use with the 3900 AutoTest II System.

9.2 GENERAL INFORMATION

This chapter describes how to use 3900 Optional Test Scripts. This chapter does not review use of the AutoTest II Option. Refer to the 3900 Operation Manual for detailed description of using the AutoTest II Option.

The information in this section applies to all 3900 AutoTest/Alignment Applications and scripts.

9.2.1 Loading Scripts

Scripts are loaded using the AutoTest II System. A script is loaded either by selecting one of the predefined optional test script buttons on the main AutoTest II Tile or by selecting a user defined script using the Test Set's Store/Recall function.

9.2.2 Enabling Tests

Test sequences are selected by enabling the individual tick boxes beside each test procedure or by pressing the Select All Tests Button which enables all test procedures.

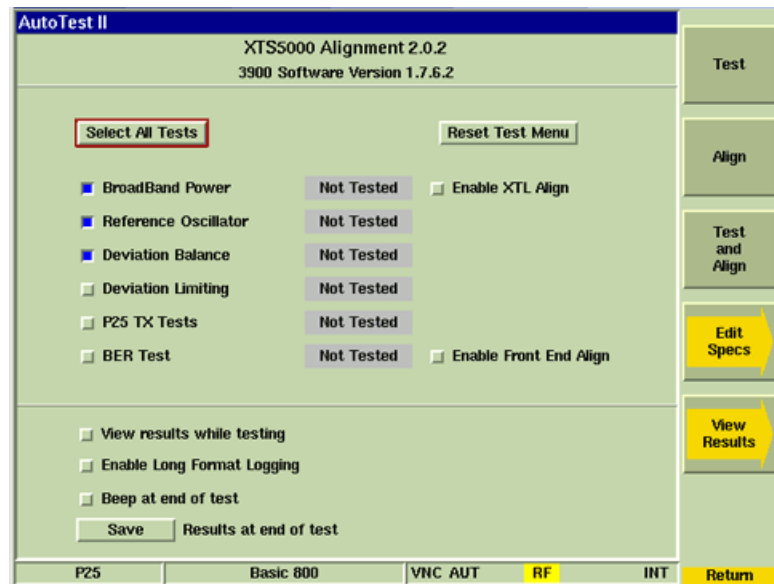

Fig. 9-1 Broadband Power, Reference Oscillator, Deviation Balance Selected

9.2.3 Main Tile Content

The Main Tile of each test script lists tests that are supported by the test script. The main tile provides access to additional parameters which are used to customize test specifications and script behavior. The main tile also displays test status while a test is in progress and when a test is completed.

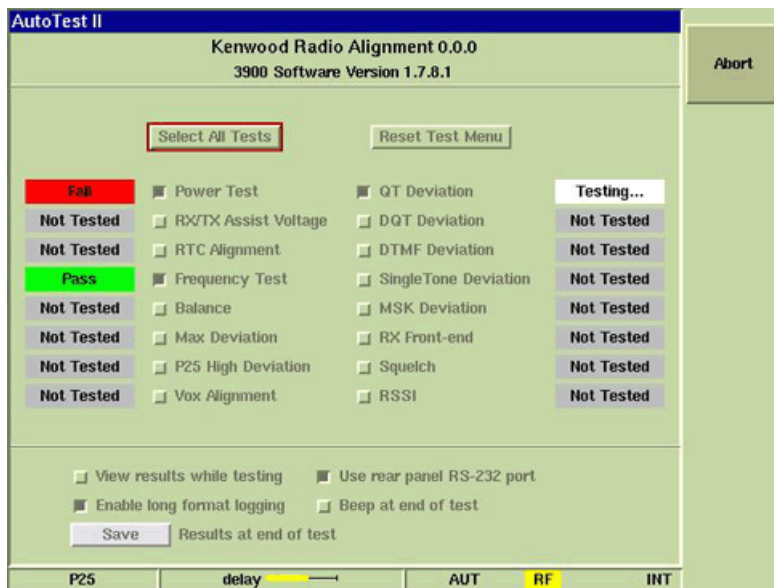

Fig. 9-2 Main Tile - Test Status Indicators

9.2.4 Common Script Functions

The functions described in this section are used throughout 3900 automated test scripts. The functions and parameters that are included in a script depend on test requirements for each radio. When present, these functions and parameters work as described in this section.

9.2.5 Common Soft Keys

The following soft keys are present throughout various 3900 Optional Test and Alignment scripts. Available soft keys depend on defined test parameters. Soft Keys are listed alphabetically.

9.2.5.A Advanced Soft Key

Allows user to select an optional interface for running automated script.

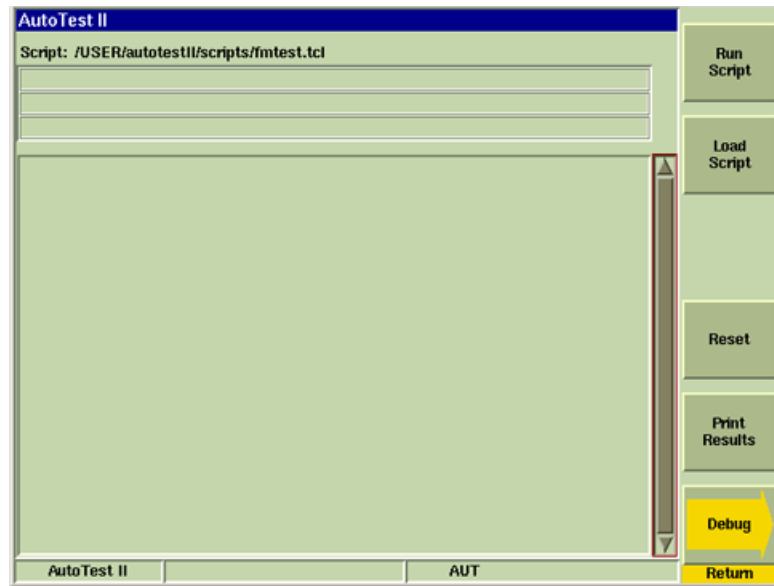

Fig. 9-3 Advanced Soft Key User Interface

9.2.5.B Align Soft Key

The Align Soft Key aligns all radio frequencies to values defined on the Edit Specifications Tile. Any enabled P25 and/or BER tests are performed after the alignment procedure is complete.

9.2.5.C Cable Loss Soft Key

The Cable Loss Soft Key accesses soft keys which are used to create tables of amplitude loss for up to three test cables of different configurations. For example, one test cable may be a direct connect to the radio and another may include a 6 dB pad for use with testing high power mobiles.

Pressing the Cable Loss 1, 2 or 3 Soft Key initiates a guided procedure for defining cable loss tables. The Test Set provides a series of on-screen instructions that the user follows to create each table.

NOTE Cable Loss table definition uses the 3900 Tracking Generator to calculate the amplitude loss values of each cable. The 3900 Tracking Generator Option must be installed in the Test Set to use the Cable Loss function.

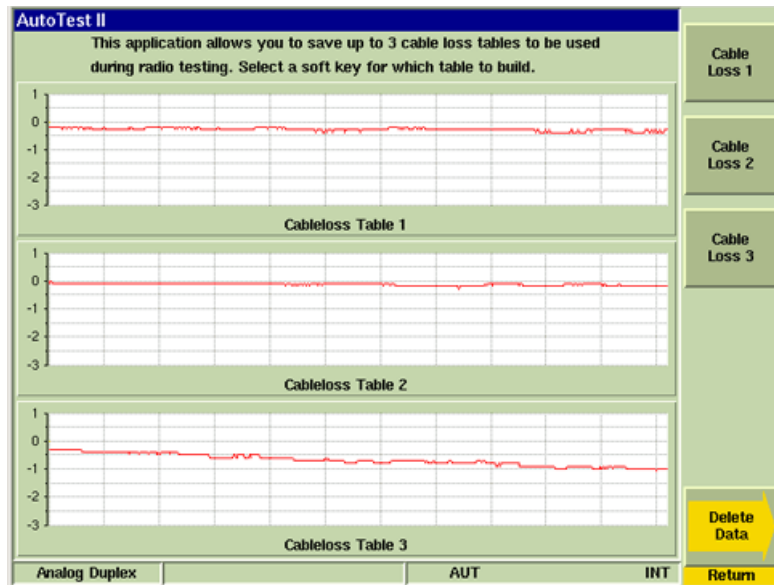

Fig. 9-4 Cable Loss Tables Defined

9.2.5.D Clear Soft Key

The Clear Soft Key clears all displayed test data, but does not erase any saved results.

9.2.5.E Edit Specs Soft Key

Accesses a Specifications Tile which contain parameters which are associated with each particular script. Contents of the Specifications Tile differ for each test script.

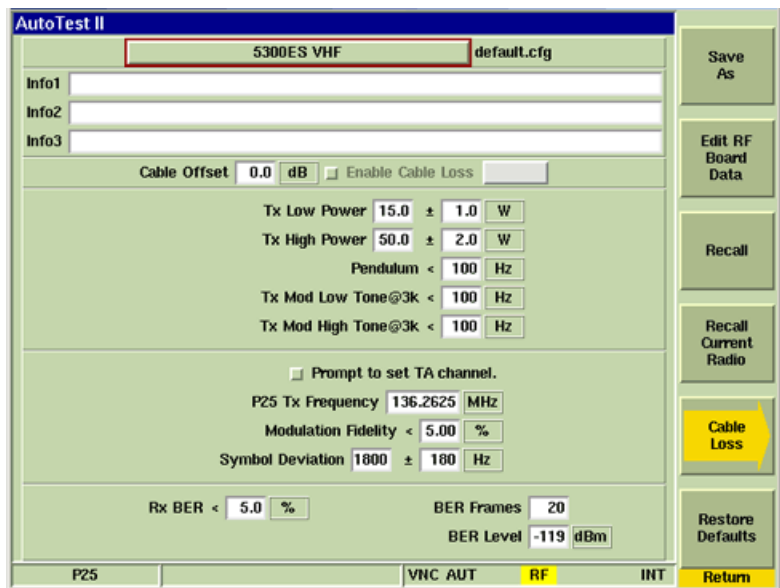

Fig. 9-5 Specifications Tile Example

9.2.5.F Info Soft Key

Pressing the Info Soft Key displays information specific to the selected test. Content lists the option name associated with the script file, equipment required to run tests included in the script, the types of radios tested by the script and other available related options.

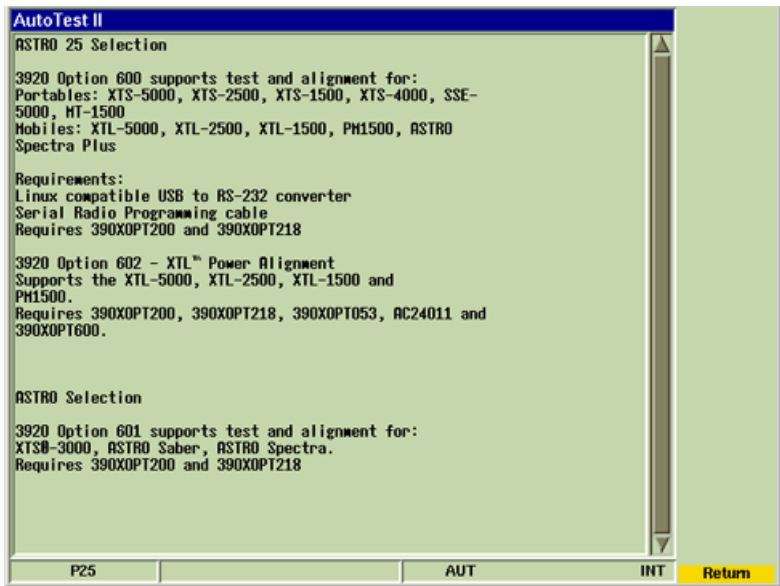

Fig. 9-6 Motorola ASTRO 25 Autotest Information

9.2.5.G Instruments Soft Key

The Instruments Soft Key allows the user to load an operating system within the AutoTest II System. Loading an instrument via this soft key does not exit the AutoTest II System. AutoTest II can only be exited by selecting an operating system from the Systems Configuration Menu.

9.2.5.H Load File Soft Key

The Load File Soft Key allows the user to load a previous results file.

9.2.5.I Load System Soft Key

The Load System Soft Key allows the user to load an operating system within the AutoTest II System. Loading a system via this soft key does not exit the AutoTest II System. AutoTest II can only be exited by selecting an operating system from the Systems Configuration Menu.

NOTE	To determine whether the Test Set is operating in the AutoTest II System or a different operating system, press the Config Key to see if the AutoTest Configuration Tile is available. The AutoTest Configuration Tile is only available when AutoTest II System is loaded.
-------------	---

9.2.5.J Print Results Soft key

The Print Results Soft Key sends the loaded results file to a local or network printer. Refer to Printer Configuration Tile for information about how to configure the Test Set for local or network printing.

9.2.5.K Recall Soft Key

The Recall Soft Key opens a dialog box which allows the user to recall any saved specifications files.

9.2.5.L Recall Current Radio Soft Key

When the Recall Current Radio Soft Key is pressed, the Test Set connects with the UUT to determine what radio is being tested and then defines test specifications based on information obtained from the UUT.

9.2.5.M Restore Defaults Soft Key

Pressing the Restore Defaults Soft Key resets all Edit Specification values to factory default state. Any unsaved changes will be lost when this soft key is pressed.

9.2.5.N Results at End of Test

The Results at End of Test drop-down menu selects how the Test Set manages results when a test is complete.

9.2.5.O Save As Soft Key

Pressing the Save As Soft Key saves the current set of specifications to the Test Set's internal database using a manually entered file name. The configuration file can later be loaded by pressing the Recall Soft Key.

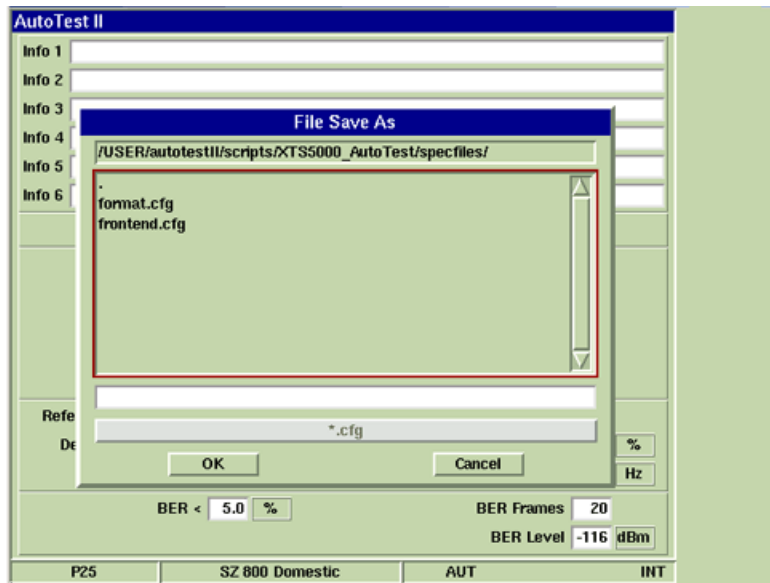

Fig. 9-7 Specification Save As Dialog Box

9.2.5.P Save As Current Radio Soft Key

Pressing the Save as Current Radio Soft Key saves the current set of specifications to the Test Set's internal database using a system assigned file name. The system assigns a file name using the first five characters of the radio's model number (i.e., M20QT.cfg). Test Scripts are designed to automatically search for and recall specification files of radios under test. For example, if a user is testing model WXYZ, and there is a saved specification file for WXYZ.cfg, the test recalls the WXYZ.cfg specification file and the user does not need to reconfigure the test specification.

9.2.5.Q Store Recall Soft Key

The Store Recall Soft Key opens a dialog window which allows the user to load a stored script file instead of loading a predefined test script.

9.2.5.R Test Soft Key

The Test Soft Key initiates the XTS™ 5000 Automatic Test procedure. This function does not auto-align any radio frequencies that fail a specific test procedure. Define test parameters on the Edit Specifications Tile before starting test.

9.2.5.S Test and Align Soft Key

The Test and Align Soft Key tests UUT parameters and frequencies. If any radio frequencies fail a test, the test procedure auto-aligns these frequencies to the values defined on the Edit Specifications Tile.

9.2.5.T View Results Soft Key

The Results Soft Key accesses the data from the last test sequence. When the test sequence is completed, test data for each test is listed under the appropriate test heading and PASS/FAIL status is listed at the end of the results file for each test. Soft keys on the Results Tile provide options on handling result files.

The Results at End of Test drop-down menu defines how the Test Set handles results when a test is completed. The parameter default value is to Save results at the end of each test.

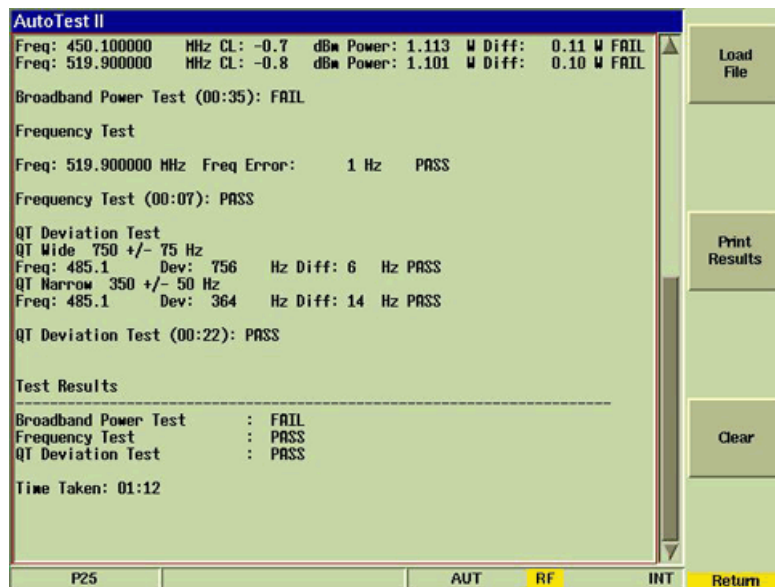

Fig. 9-8 Results Tile - Full Test Sequence

9.2.6 Common Fields

The following fields are present throughout various 3900 Optional Test and Alignment scripts. Available fields depend on defined test parameters. Fields are listed alphabetically.

9.2.6.A Beep at end of test

When the Beep at end of test tick box is selected the Test Set emits an audible beep when a test or test sequence is completed.

9.2.6.B Cable Offset

Cable Offset should be defined as a negative value only. Power meter readings are compensated by the defined Cable Offset value. Cable Offset can be used to compensate for the external interconnect cable and/or an external attenuator if used for higher power transmitters. The Cable Offset value is also used to compensate the RF Generator level when testing receiver BER.

9.2.6.C Enable Cable Loss

Cable Loss mode provides the ability to sweep a test cable to determine the cable loss at each test frequency for all bands. Cable Loss mode requires the use of a reference cable and an coupling adaptor to connect the two cables together.

The Enable Cable Loss tick box is enabled after one or more Cable Loss tables have been defined. When Cable Loss is enabled the Table drop-down menu is available to select the cable loss table to be used for performing the test procedures.

Refer to Cable Loss Soft Key for additional information.

9.2.6.D Enable Long Format Logging

The default format for logging test data reports the beginning and ending soft pot values of the alignment. When Long Format Logging is enabled, the test data includes each adjustment performed when aligning a frequency.

9.2.6.E Results at end of test

The End of Test drop-down menu defines how the Test Set handles test results at the end of a test or test sequence.

- Save: Results are saved automatically.
- Ask: User is prompted to save files.
- Print: Results are automatically printed.
- Save & Print: Results are automatically saved and printed.
- Skip: Ignores test results

When the Test Set saves results, filenames are generated and stored in the following format:

Model_Number-Serial_number-month_day_year-hour_min.txt

9.2.6.F Reset Test Menu

Pressing the Reset Test Menu resets all test procedure tick boxes to Disabled. Pressing the Reset Test Menu button does not affect any other parameters on the Main User Tile. For example, the Enable XTL Align and Beep at end of test tick boxes are selected, pressing the Reset Test Menu button does not deselect these parameters.

9.2.6.G Select All Tests

Pressing the Select All Tests button enables all tests listed on the main test tile.

9.2.6.H Use Rear Panel RS-232 Port

Selects the Test Set's RS-232 Connector as the UUT interface for test setup.

9.2.6.I View results while testing

Enabling this function displays the automated test procedure while it is running. User can not return to the Main User Tile during a test when this function is selected.

9.3 XTS™ 5000 AUTOMATIC ALIGNMENT SYSTEM (390XOPT600)

The XTS™ 5000 Automatic Alignment System provides users with an automated test script for testing Motorola XTS™ 5000 Radios. The XTS™ 5000 Automatic Alignment test procedure is designed to allow the 3900 to communicate directly with the unit under test (UUT) following initial configuration performed by the user (refer to [Preliminary Procedures](#)).

Refer to the [XTS™ 5000 Alignment Software Data Sheet](#) for a detailed description of software functionality and a list of radio models which can be tested with the XTS™ 5000 Automatic Alignment System.

9.3.1 Preliminary Procedures

The Power Level and Cable Offset parameters on the Edit Specifications Tile are used as pass/fail and alignment criteria for the test and align procedures and must be defined prior to running the XTS™ 5000 Automatic Alignment procedure. Once these parameters are defined, the XTS™ 5000 Automatic Alignment Test runs without user interaction.

9.3.2 Hardware Configuration

The setup shown in Fig. 9-9 is for testing UUT's with power rating below 50 Watts.

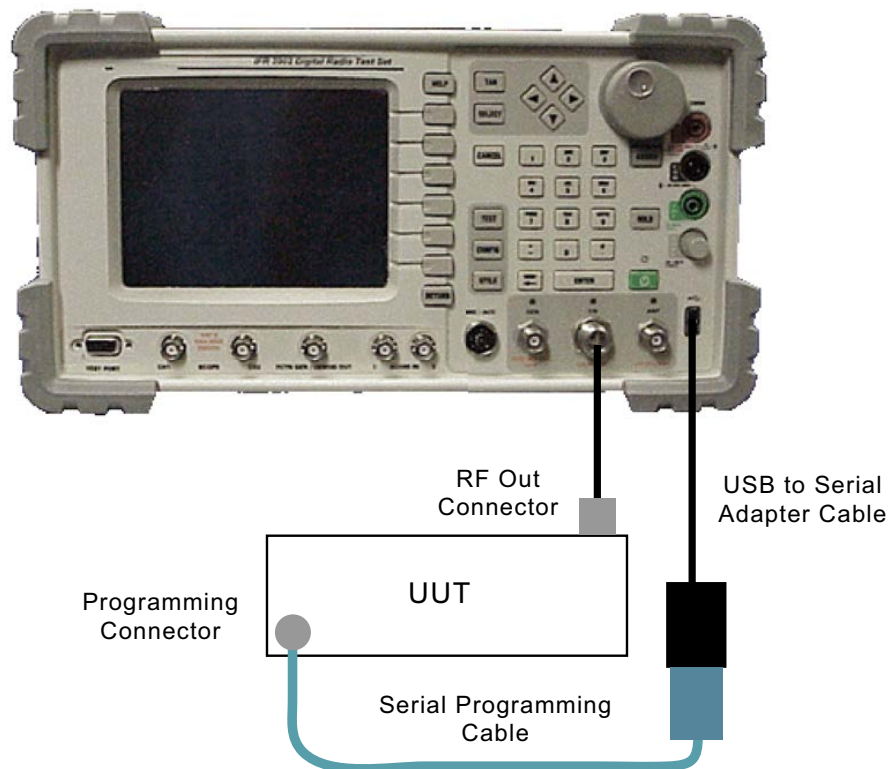

Fig. 9-9 Portable/Mobile UUT <50 Watts Test Setup

The setup shown in Fig. 9-10 is for testing UUT's with power rating higher than 50 Watts.

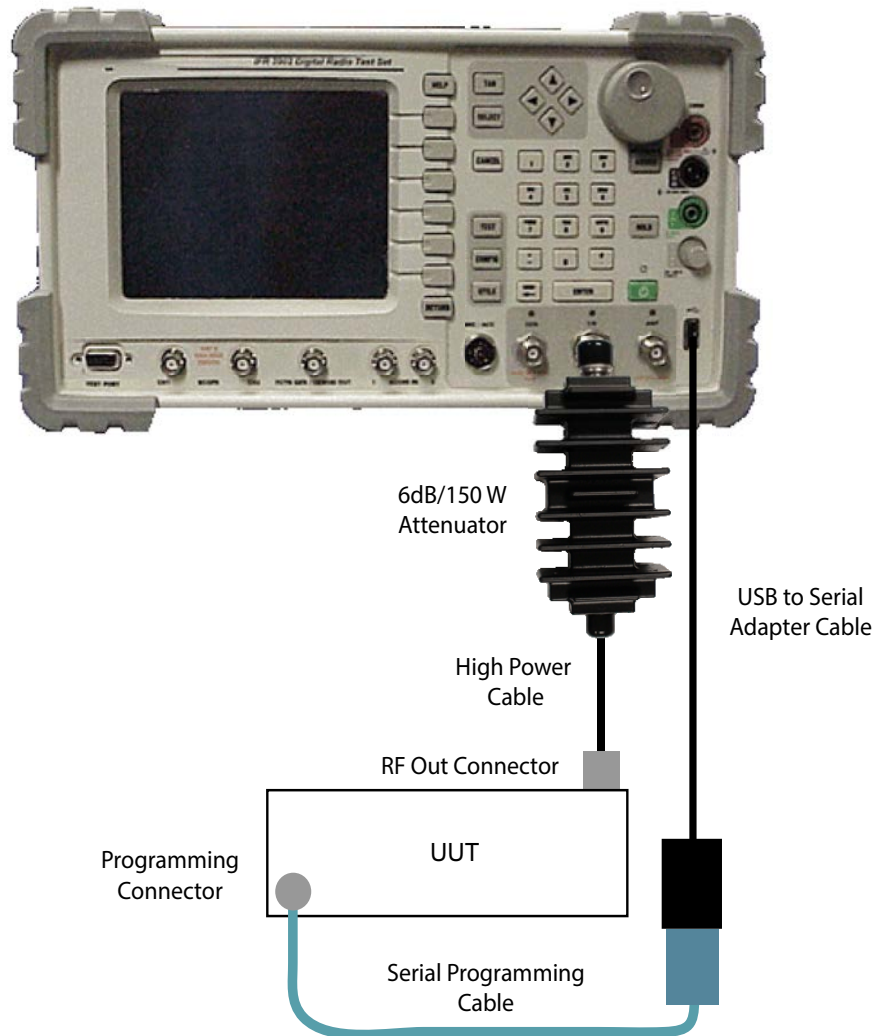

Fig. 9-10 Mobile >50 Watts Test Setup

9.4 XTS™ 3000 AUTOMATIC ALIGNMENT SYSTEM (390XOPT601)

The XTS™ 3000 Automatic Alignment System provides users with an automated test script for testing Motorola XTS™ 3000 Radios. The XTS™ 3000 Automatic Alignment test procedure is designed to allow the 3900 to communicate directly with the unit under test (UUT) following initial configuration performed by the user (refer to [Preliminary Procedures](#)).

9.4.1 Preliminary Procedures

The user must define the Power Level and Cable Offset parameters (Edit Specifications Tile) for the UUT prior to running the XTS™ 3000 Automatic Alignment test. Once these parameters are defined, the XTS™ 3000 Automatic Alignment Test runs without user interaction.

9.4.2 Hardware Configuration

The setup shown in Fig. 9-11 is for aligning portable radios with power rating below 50 Watts.

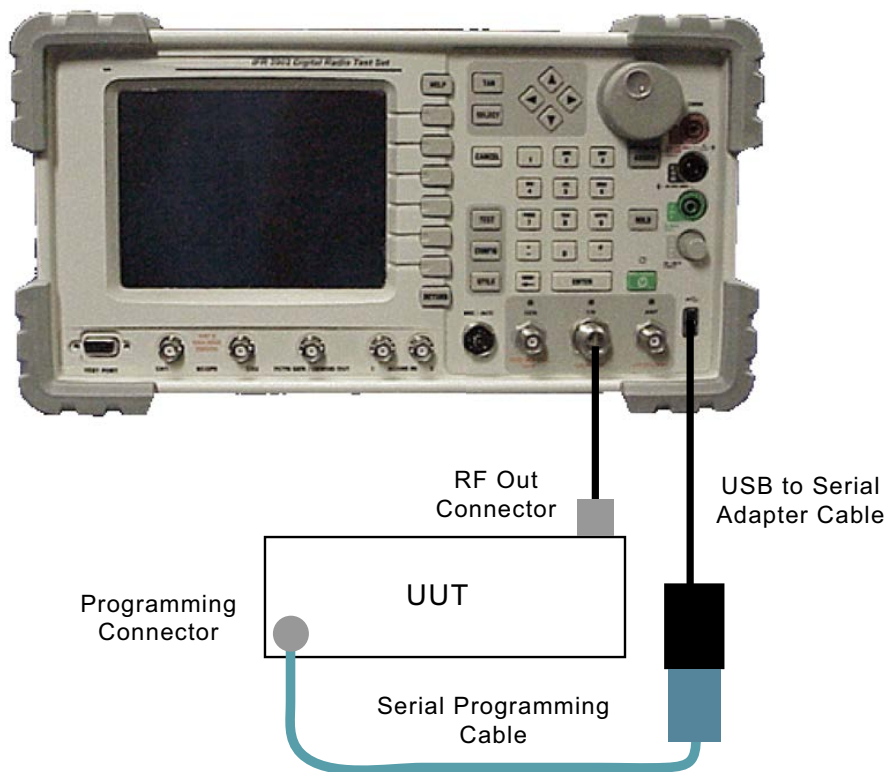

Fig. 9-11 Portable UUT <50 Watts Test Setup

The setup shown in Fig. 9-12 is for testing UUT's with power rating higher than 50 Watts.

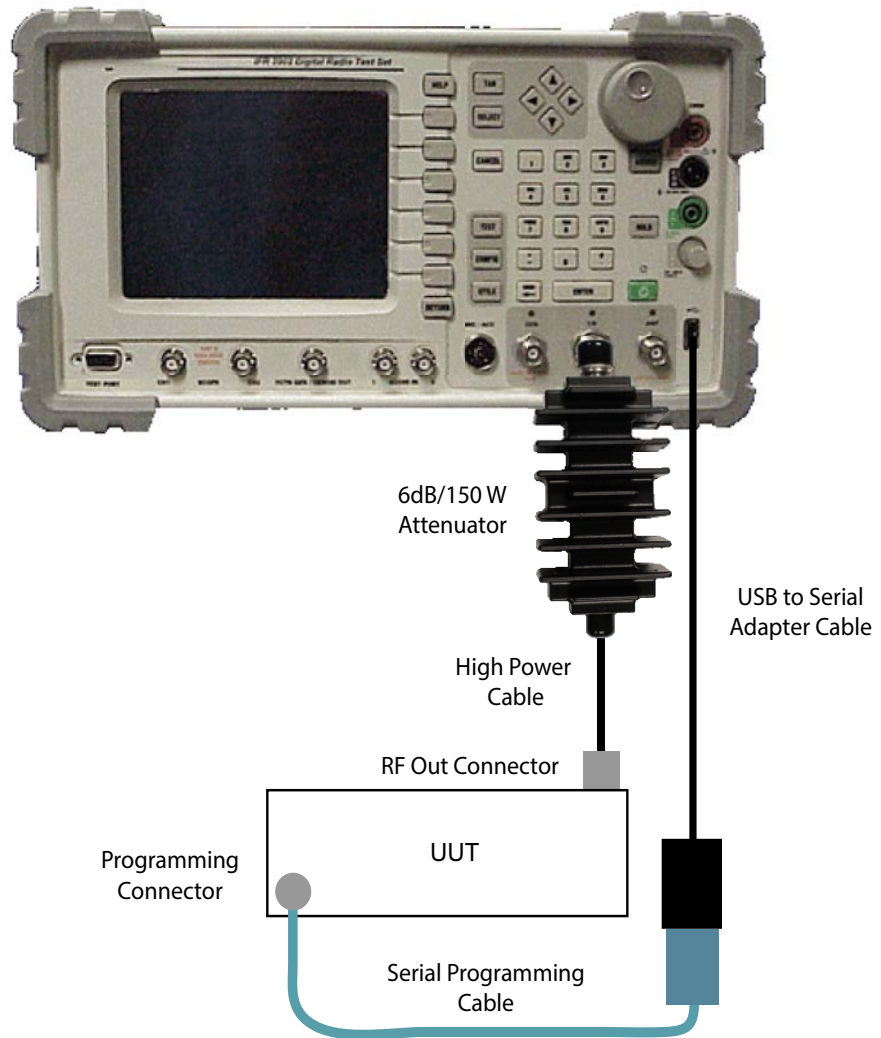

Fig. 9-12 Mobile >50 Watts Test Setup

9.5 XTL POWER ALIGNMENT OPTION (390XOPT602)

Provides users with the ability to align power of XTL Mobile radios. Requires XTS™ 5000 Automatic Alignment System (390XOPT600) and 20 AMP Current Shunt DMM Accessory. The XTL Power Alignment Option is integrated into the XTS™ 5000 Automatic Alignment System as an option enabled parameter.

9.5.1 Enable XTL Power Alignment

STEP	PROCEDURE
------	-----------

1. Load AutoTest II System.
2. Select Motorola ASTRO 25 Autotest button on the AutoTest II main tile.
3. Select the Enable XTL Align tick box on the Motorola ASTRO 25 main tile.

9.5.2 Preliminary Procedures

The Power Level plus Cable Offset parameters on the Edit Specifications Tile are used as pass/fail criteria for the test and must be defined prior to running the XTS™ 5000 Automatic Alignment procedure. Once these parameters are defined, the XTS™ 5000 Automatic Alignment Test runs without user interaction.

9.5.3 Hardware Configuration

The setup shown in Fig. 9-13 is for performing XTL Power Alignment on XTL mobiles.

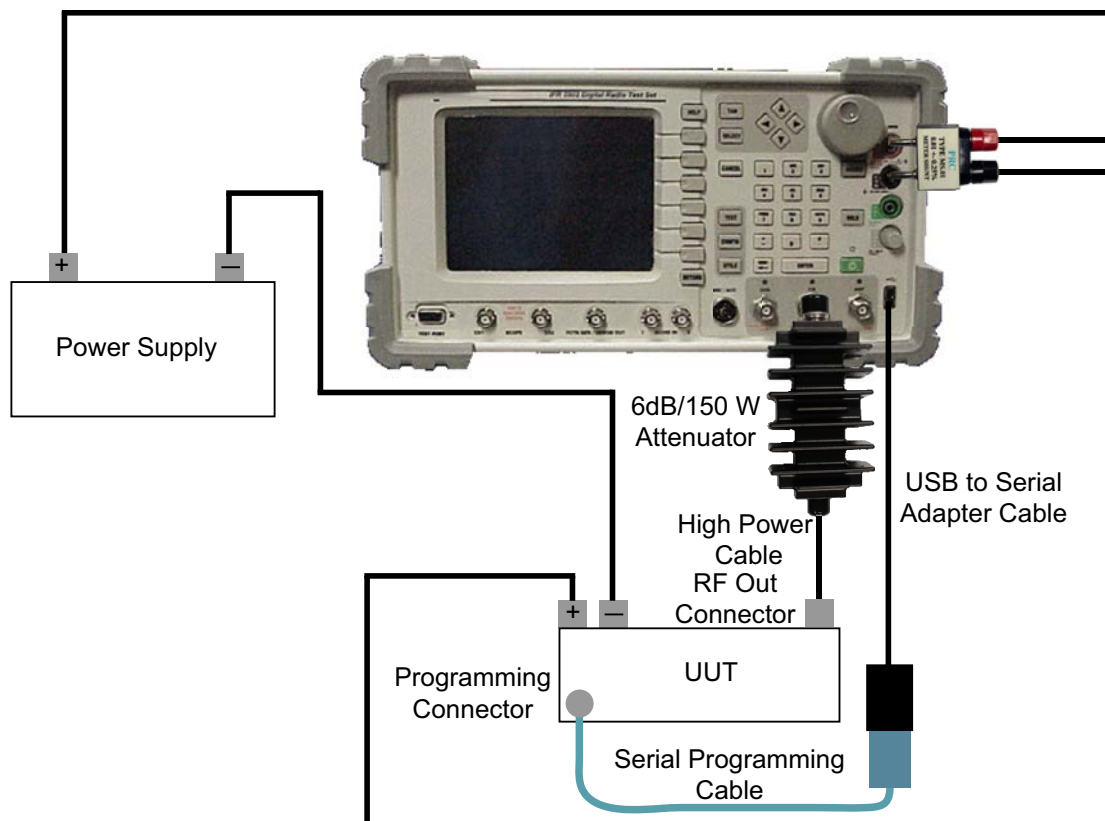

Fig. 9-13 Power Alignment Test (Opt 602) Test Setup

9.6 TIA-603 LMR AUTOTEST APPLICATION (390XOPT603)

The TIA-603 LMR AutoTest Application provides users with an automated test script for testing Land Mobile Radios.

9.6.1 How to Use TIA-603 LMR AutoTest Application

The TIA-603 LMR AutoTest Application has been designed as a template from which customized LMR radio test scripts can be developed. This application was developed for users familiar with using the 3900 and the 3900 AutoTest II option.

When the TIA-603 LMR AutoTest Application is loaded, the system always loads the default.cfg setup file. The TIA-603 LMR AutoTest Application has been designed so that users can edit and save over the default.cfg setup file. This functionality has been included so that the Test Set is ready to test a specific radio after the application is loaded.

Before a radio can be tested, Test Set and UUT parameters must be defined on the various tiles found in the TIA-603 LMR AutoTest Application. Test parameters should be defined according to UUT functionality and product specifications. For example, if the radio under test does not have squelch control, do not enable Squelch Control parameter on the Rx Configuration Tile.

A test setup file consists of the entire test sequence which is comprised of separate Channel test sequences. For example, a test setup file can consist of up to 30 Channel test sequences. Each Channel test sequence can consist of different tests to be performed for each channel.

9.6.1.A Steps to Creating a New Test Setup:

9.6.1.A.1 Channel Configuration

STEP	PROCEDURE
1.	Load the Land Mobile Radio Test Application. After the application loads press the Continue Soft Key.
2.	Press the Configure Channels Soft Key.
3.	Select the Enable tick box to include the setup data in the test sequence.
4.	Enter the radio's Channel to be tested in the Label field.
5.	Define the Rx and Tx Frequencies, Tx Power, Squelch Type and Squelch Code according to UUT specifications and test requirements.
6.	Select the tests to be performed for the Channel test sequence.
7.	Press Next Channel Soft Key to configure additional channels to be included in the test.
8.	When all the Channels are configured, press the Save Configuration Soft Key to save the test setup file.

9.7 MOTOROLA APX7000 RADIO ALIGNMENT (390XOPT604)

The Motorola APX7000 Series Radio Alignment Option provides users with an automated test script for testing Motorola APX7000 radios.

9.7.1 Preliminary Procedures

None.

9.7.2 Hardware Configuration

The setup shown in Fig. 9-14 is for testing Motorola APX7000 radios.

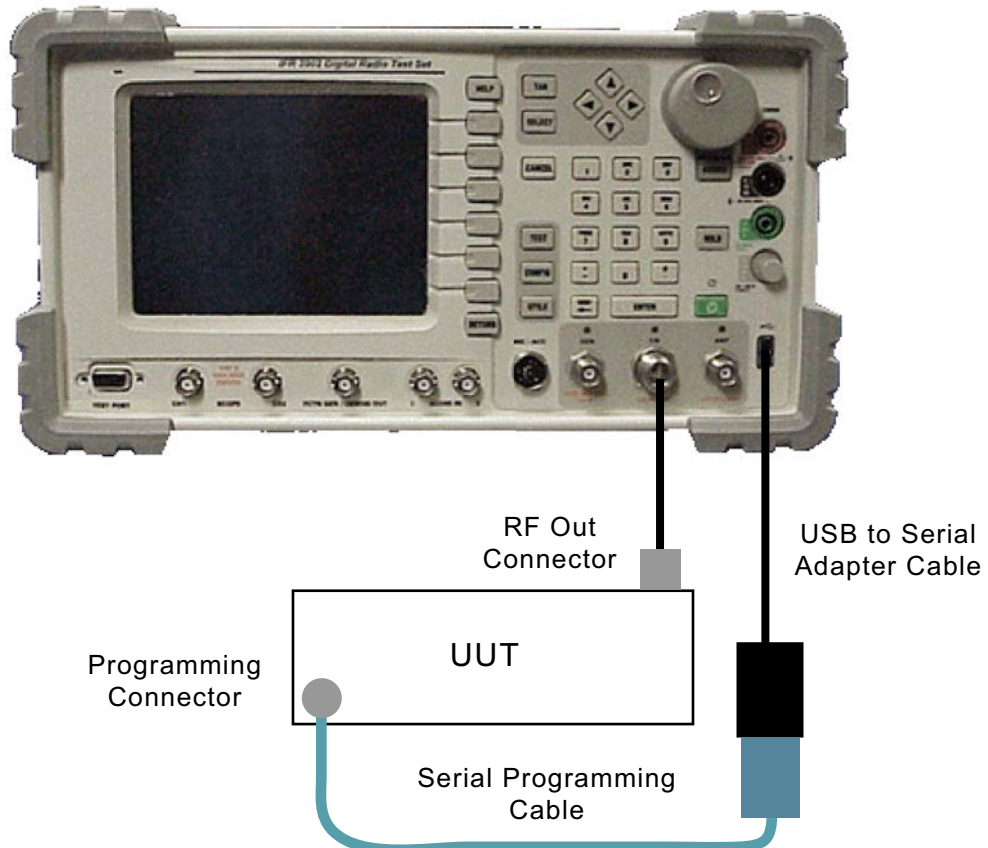

Fig. 9-14 Motorola APX7000 AutoTest Test Setup

9.8 EF JOHNSON 5100/5300 RADIO ALIGNMENT (390XOPT606)

The EF Johnson Radio Alignment Option provides users with an automated test script for testing EF Johnson 5100/5300 radios.

9.8.1 Preliminary Procedures

None.

9.8.2 Hardware Configuration

The setup shown in Fig. 9-15 is for testing EF Johnson handheld radios.

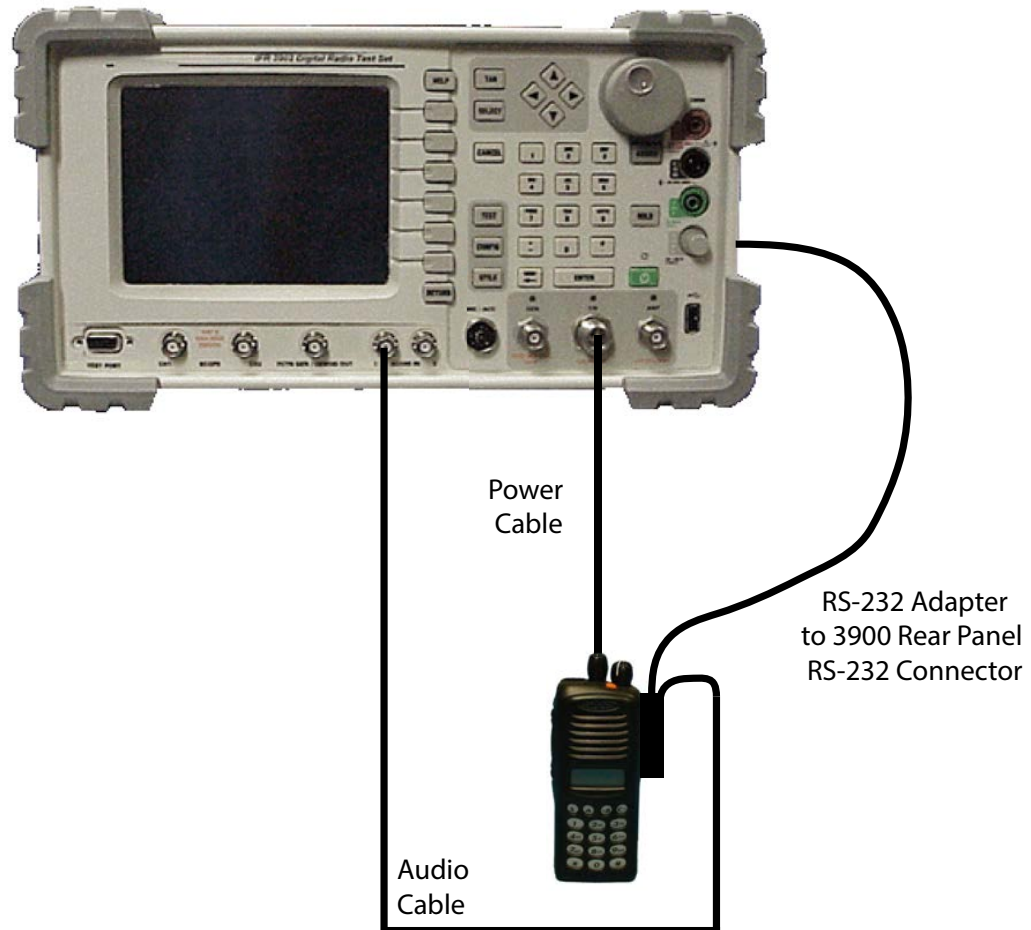

Fig. 9-15 EF Johnson Handheld Radio Alignment Test Setup

The setup shown in Fig. 9-16 is for testing EF Johnson mobile radios.

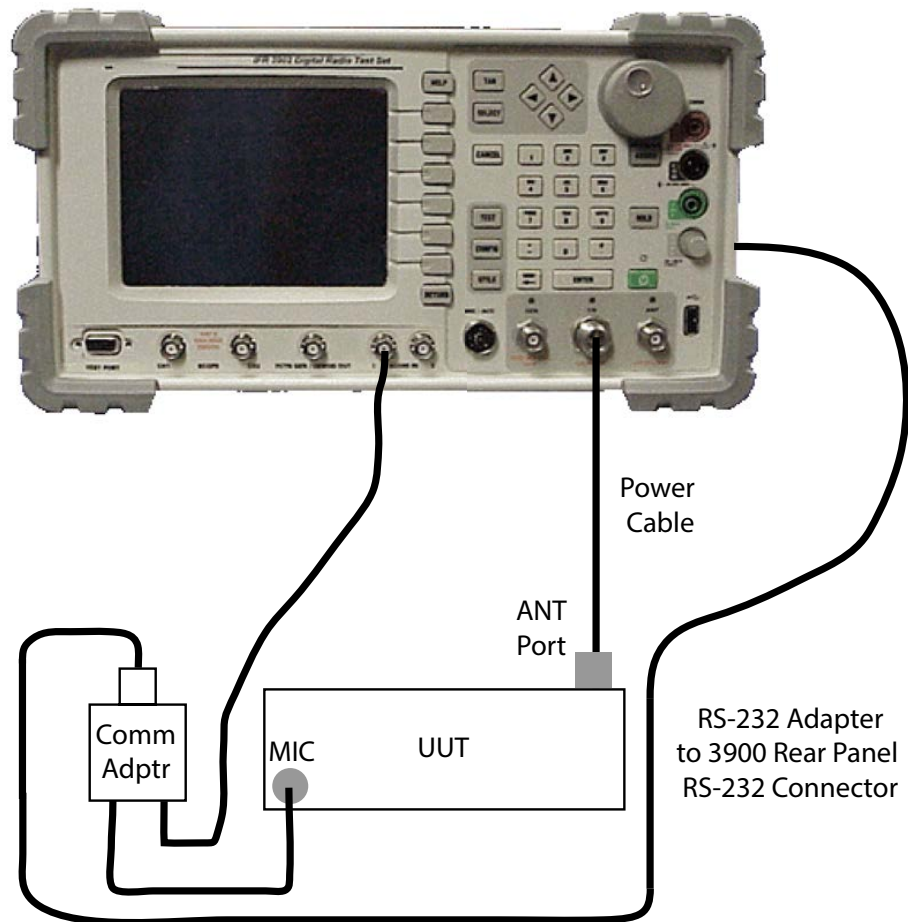

Fig. 9-16 EF Johnson Mobile Radio Alignment Test Setup

9.9 BK DPHX RADIO ALIGNMENT (390XOPT607)

The BK DPHx Radio Alignment Option provides users with an automated test script for testing Bendix King DPHx series radios.

9.9.1 Preliminary Procedures

None.

9.9.2 Hardware Configuration

The setup shown in Fig. 9-17 is for testing BK DPHx handheld radios.

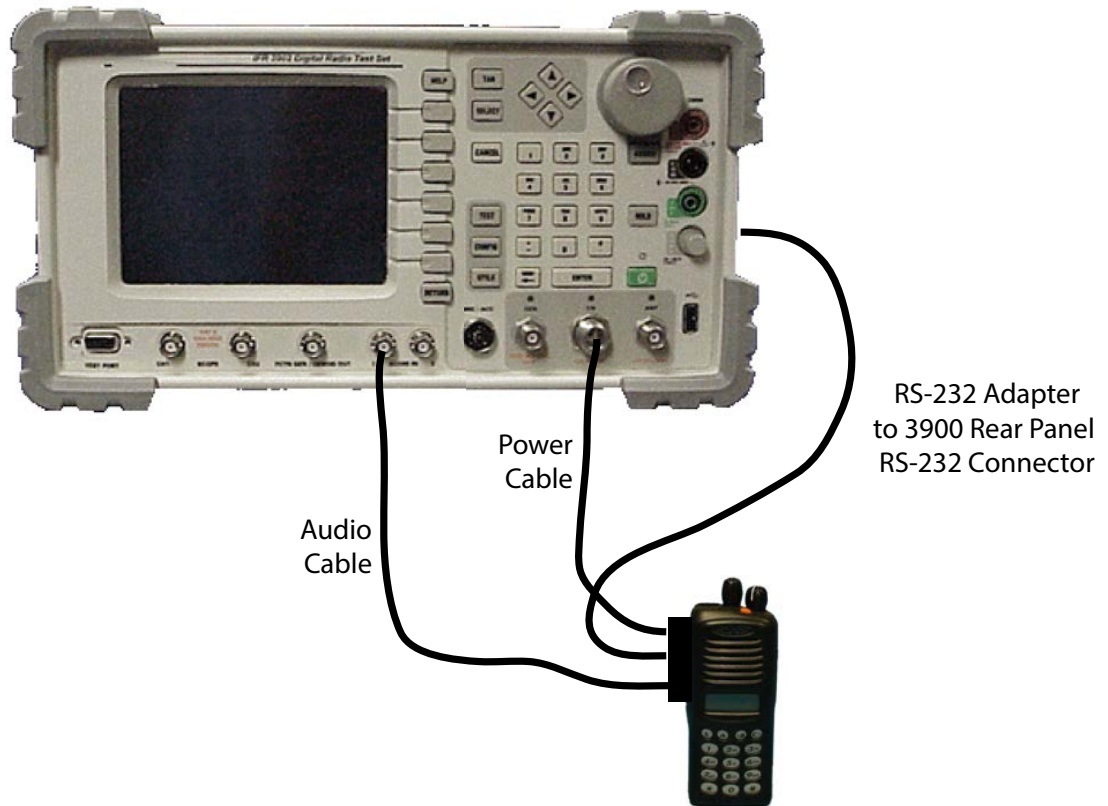

Fig. 9-17 BK DPHx Handheld Radio Alignment Test Setup

9.10 KENWOOD P25 TK-5X10G SERIES RADIO AUTOTEST/ALIGNMENT (390XOPT608)

The Kenwood P25 TK-5X10G Series Radio AutoTest/Alignment Option provides users with automated test and alignment capabilities for evaluating Kenwood P25 TK-5X10G Series radios. Features allow the user to evaluate radio parameters such as power, frequency, modulation balance, deviation and squelch. Test capabilities include P25 performance testing.

Refer to the 3920 Series Data Sheet for a list of radios supported by the Kenwood P25 TK-5X10G Series Radio AutoTest/Alignment Option.

9.10.1 Preliminary Procedures

None.

9.10.2 Hardware Configuration

The setup shown in Fig. 9-18 is for testing Kenwood P25 TK-5X10G Series handheld radios.

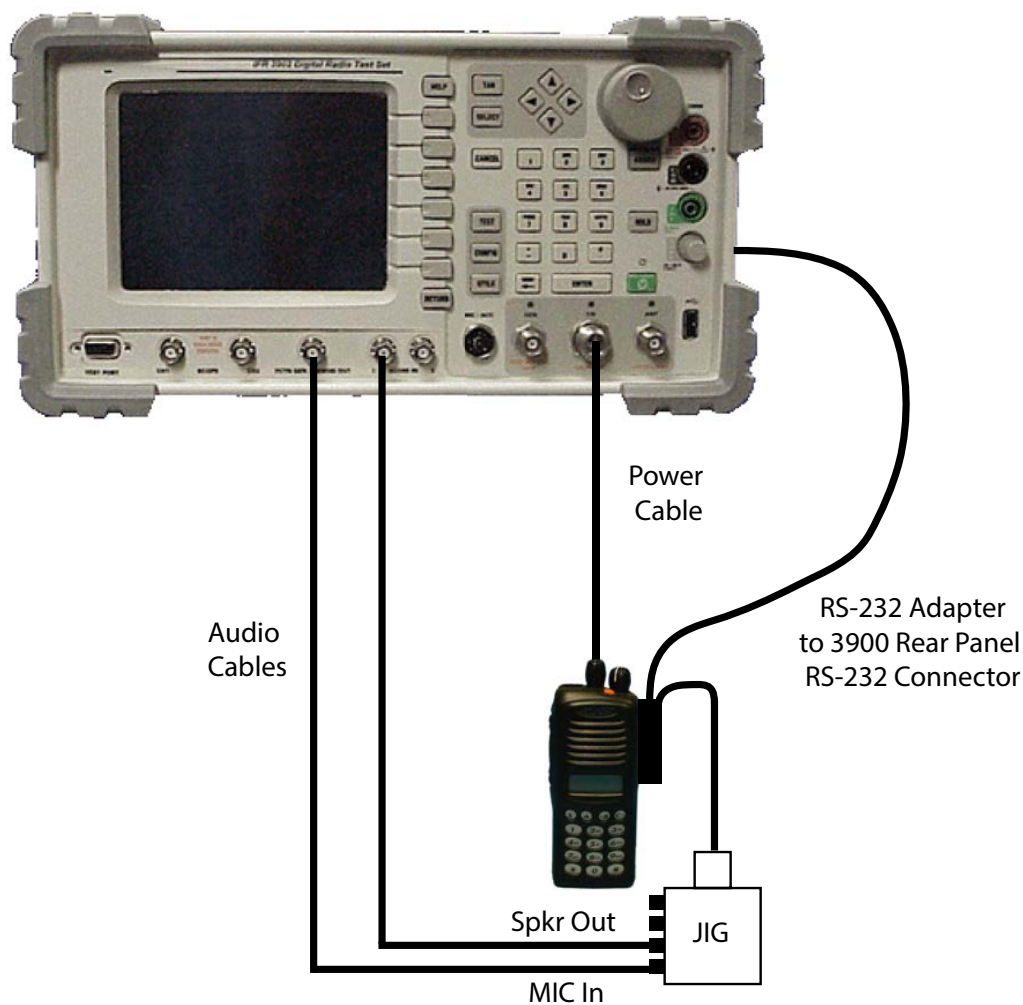

Fig. 9-18 Kenwood P25 TK-5X10G Handheld Series Radio Test/Alignment Test Setup

The setup shown in Fig. 9-19 is for testing Kenwood P25 TK-5X10G Series mobile low-power radios.

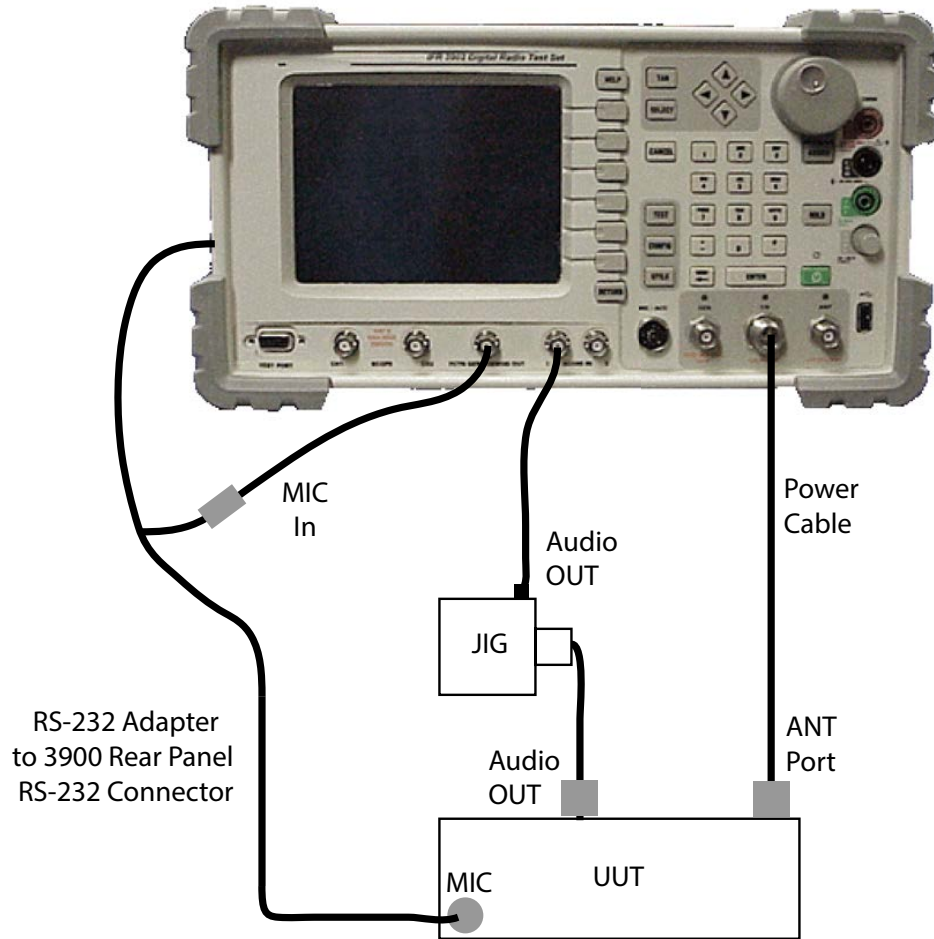

Fig. 9-19 Kenwood P25 TK-5X10G Mobile Series Low-Power Radio Test/Alignment Test Setup

The setup shown in Fig. 9-20 is for testing Kenwood P25 TK-5X10HG Series mobile high-power radios.

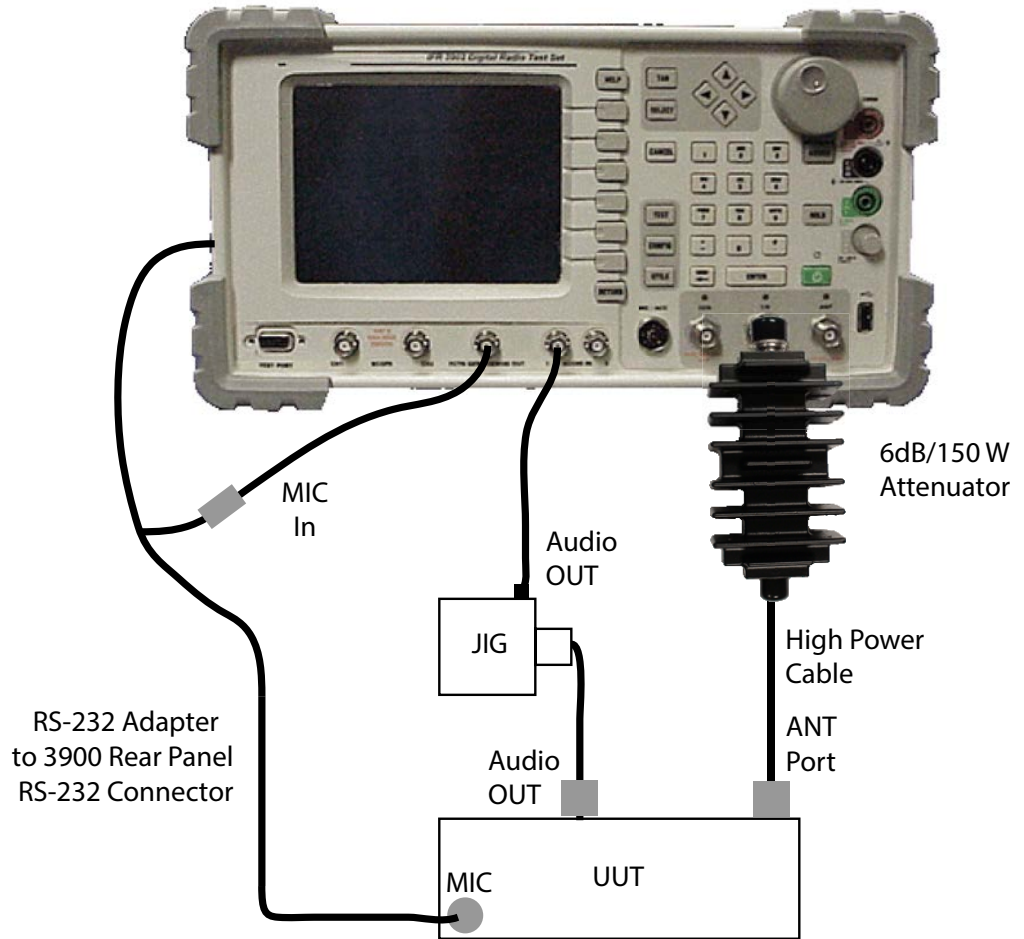

Fig. 9-20 Kenwood P25 TK-5X10HG Mobile Series High-Power Radio Test/Alignment Test Setup

9.11 MOTOTRBO RADIO SERIES AUTOTEST/ALIGNMENT (390XOPT610)

The MOTOTRBO Radio Series AutoTest/Alignment Option provides users with automated test and alignment capabilities for evaluating MOTOTRBO Series radios. The MOTOTRBO Radio Series AutoTest/Alignment Option is compatible with all MOTOTRBO hand-held portable radios.

9.11.1 Preliminary Procedures

None.

9.11.2 Hardware Configuration

The setup shown in Fig. 9-21 is for testing MOTOTRBO Series handheld radios.

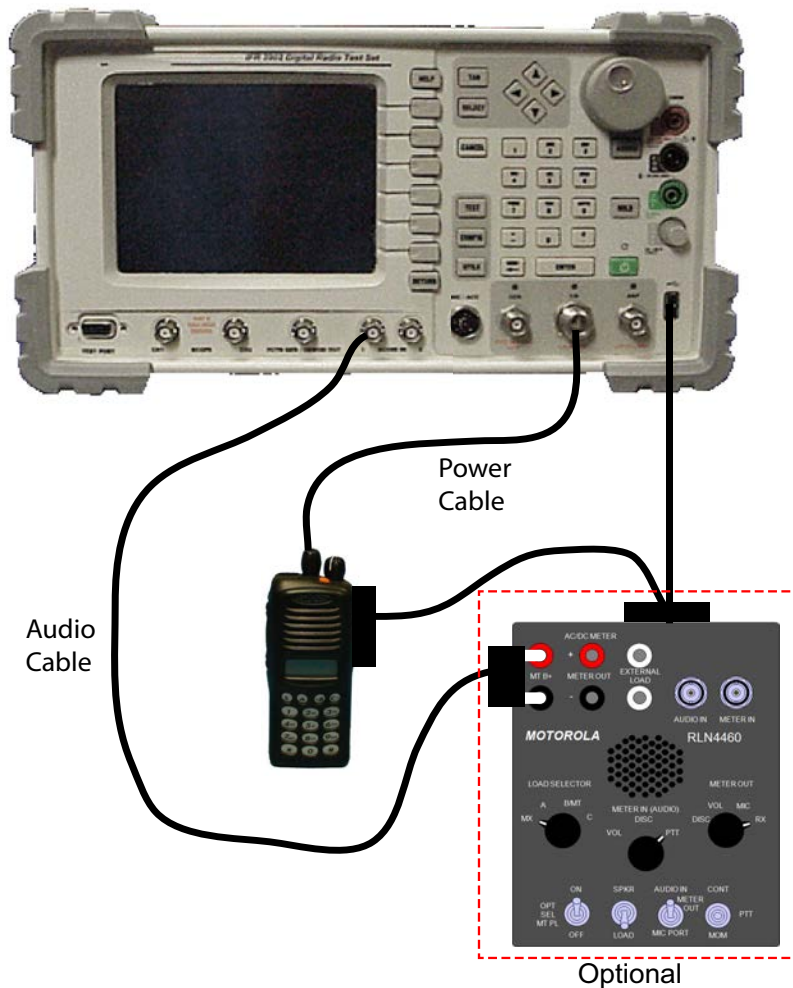

Fig. 9-21 MOTOTRBO Series Handheld Radio AutoTest/Alignment Test Setup

The setup shown in Fig. 9-22 is for testing MOTOTRBO Series mobile radios.

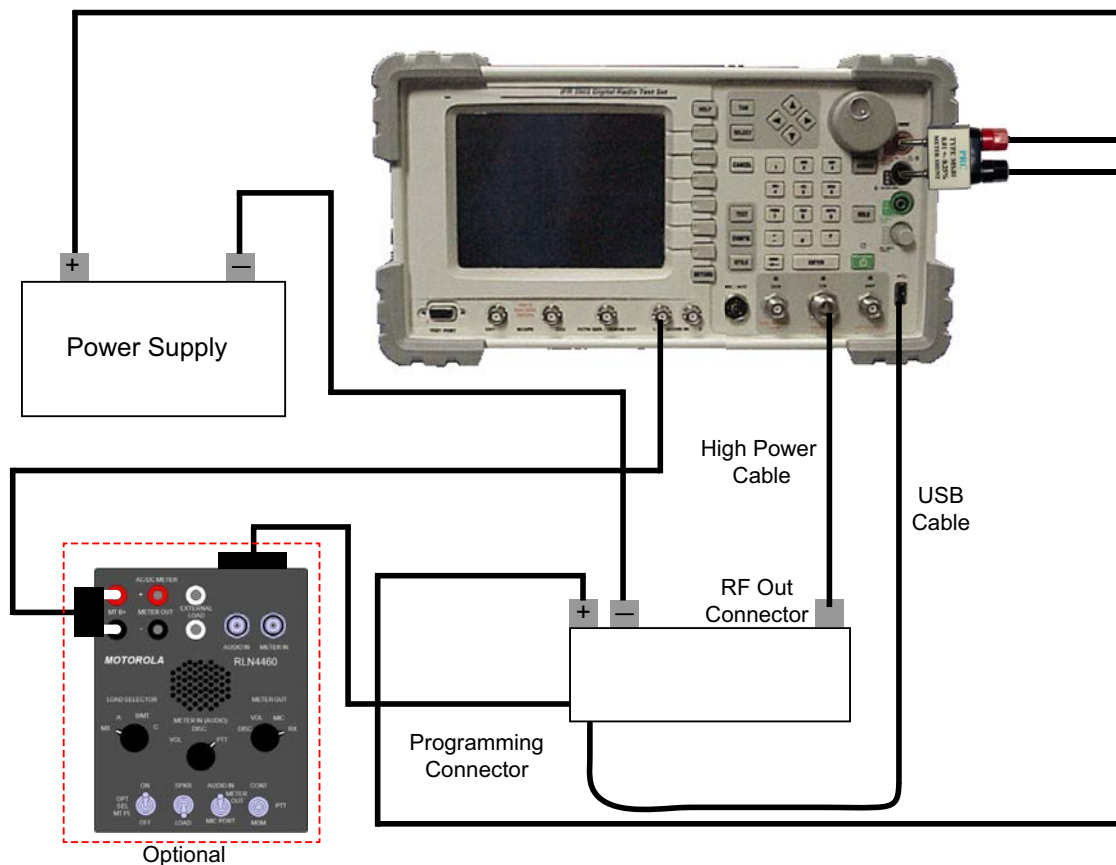

Fig. 9-22 MOTOTRBO Series Mobile Radio AutoTest/Alignment Test Setup

9.12 TECHNISONICS TYPE 1 RADIO AUTOTEST/ALIGNMENT (390XOPT614)

The Technisonics Type 1 Radio AutoTest/Alignment Option provides users with automated test and alignment capabilities for evaluating Technisonics Type 1 radios.

9.13 TECHNISONICS TYPE 2 RADIO AUTOTEST/ALIGNMENT (390XOPT615)

The Technisonics Type 2 Radio AutoTest/Alignment Option provides users with automated test and alignment capabilities for evaluating Technisonics Type 2 radios.

9.14 DMR REPEATER AUTOTEST (390XOPT626)

The DMR Repeater AutoTest Option provides users with the capability to perform fully automated key transmitter and receiver tests for DMR Repeaters. The DMR Repeater AutoTest performs measurements on any user selected frequency which has been programmed into the repeater. The DMR repeater does not need to be placed in a special test mode to use the DMR Repeater AutoTest.

Appendix A - Shipping Test Set

A.1 REPACKING FOR SHIPPING

VIAVI Test Sets returned to factory for calibration, service or repair must be repackaged and shipped subject to the following conditions:

CAUTION

FAILURE TO PROPERLY PACKAGE THE TEST SET FOR SHIPMENT MAY RESULT IN DAMAGE DURING SHIPMENT. PRODUCT WARRANTY AND FREIGHT INSURANCE (IF PURCHASED) DO NOT COVER SHIPPING DAMAGES RESULTING FROM IMPROPER PACKAGING.

A.1.1 Return Authorization

Do not return any products to factory without authorization from VIAVI Customer Service Department.

A.1.1.A CONTACT:

Contact Customer Service for technical support or with any questions regarding this or any other VIAVI products.

VIAVI Solutions, Inc.
Customer Service Department
10200 West York Street
Wichita, KS 67215
Telephone: 800-835-2350
Fax: 316-529-5330
email: AvComm.Service@viavisolutions.com

A.2 TAGGING TEST SETS

All test sets must be tagged with:

- Owner's identification and address.
- Nature of service or repair required.
- Model No. and Serial No.

A.3 SHIPPING CONTAINERS

Test Sets must be repackaged in original shipping containers using VIAVI packing materials. If original shipping containers and materials are not available, contact VIAVI Customer Service Department for shipping instructions.

A.4 FREIGHT COSTS

All freight costs on non-warranty shipments are assumed by the customer.

A.5 REPACKING PROCEDURE

STEP

PROCEDURE

1. Place Test Set in storage position as shown with handle adjusted and locked against Test Set.

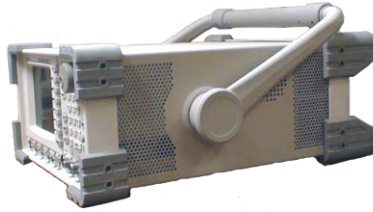

CAUTION

DO NOT SHIP THE TEST SET WITH HANDLE EXTENDED. FAILURE TO PLACE HANDLE AGAINST TEST SET AS SHOWN MAY RESULT IN DAMAGE TO THE UNIT.

2. Place one foam insert on a solid flat surface. Fold cardboard insert and place in foam insert as shown.

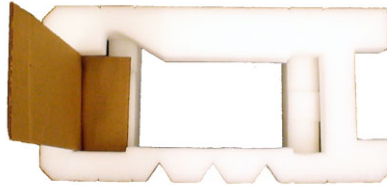

3. Place Test Set in foam insert. Cardboard insert should be against rear bumper guards.

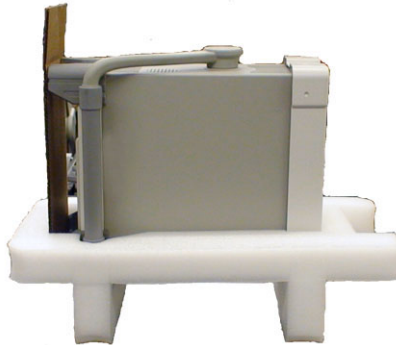

Shipping Test Set

- | STEP | PROCEDURE |
|------|---|
| 4. | Fold cardboard insert around Test Set rear bumper guard and secure by attaching other foam insert |

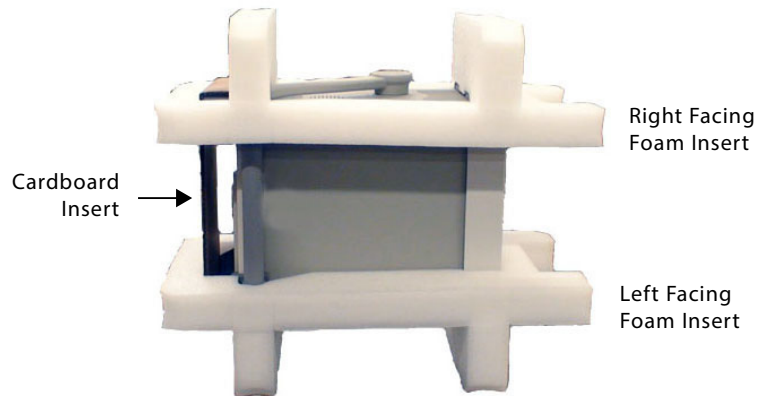

5. Secure accessory box in foam inserts (if applicable).

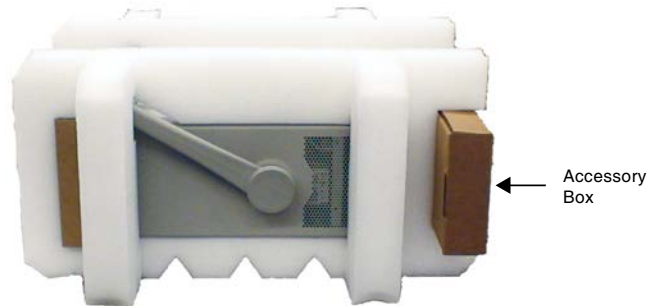

6. Place secured Test Set in shipping carton. Close shipping container lids and seal with shipping tape or an industrial stapler.

NOTE

When returning Test Set to VIAVI for service, make sure the Return Authorization (RA#) is clearly marked on the exterior of the ship carton.

THIS PAGE INTENTIONALLY LEFT BLANK.

Appendix B - 3900 Platform Specifications

3900 Platform Specifications apply to the 3901, 3902, 3920 and 3920B Test Sets except when otherwise indicated.

B.1 RF SIGNAL GENERATOR

B.1.1 Frequency

B.1.1.A Range (Usable from 100 kHz)

10 MHz to 1.05 GHz (3901, 3920, 3920B Standard)

*3920B refer to Phase Noise Specifications for freq >1.0 GHz

10 MHz to 2.7 GHz (3902, 3920, 3920B Freq Extension Option [390XOPT058])

B.1.1.B Resolution

1 Hz

B.1.1.C Accuracy

Frequency Standard ± 1 count

B.1.2 Output Level

B.1.2.A Range

T/R: -130.0 to -30.0 dBm

GEN: -130.0 to +10.0 dBm (+10 dBm max for CW or FM; 0 dBm max for complex modulation)

B.1.2.B Resolution

0.1 dB

B.1.2.C Accuracy (for level >-110 dBm)

T/R: ± 1.0 dB (Typical better than ± 0.6 dB), ± 2.0 dB (≥ 1800 MHz)

GEN: ± 1.0 dB (Typical better than ± 0.6 dB), ± 2.0 dB (≥ 1800 MHz)

RF GENERATOR (CONT)

B.1.3 Spectral Purity

B.1.3.A Residual FM

3901/3901/3920

<15 Hz RMS (300 Hz to 3 kHz bandwidth)

3920B

<5 Hz RMS (300 Hz to 3 kHz bandwidth)

B.1.3.B Residual AM

<0.1% RMS (300 Hz to 3 kHz bandwidth)

B.1.3.C Harmonics

<-25 dBc (Typical -30 dBc, RF Level set at +10 dBm)

B.1.3.D Non Harmonics

3901/3902/3920

<-55 dBc (all frequencies except Crossovers)

<-35 dBc (Crossover frequency = 3411.4 MHz - Generator frequency)

3920B

<-55 dBc (all frequencies except Crossovers)

<-35 dBc (At 2nd order Crossover frequency)

(10 MHz to 1.0 GHz: Crossover = 1400 MHz - Generator frequency)

(1 to 2.6 GHz: Crossover = 3400 MHz - Generator frequency)

(Tracking Generator: Crossover = 3410.7 MHz - Generator frequency)

B.1.3.E Phase Noise

3901/3902/3920

20 kHz Offset: <-93 dBc/Hz (RF <1.05 GHz)
<-90 dBc/Hz (RF >1.05 to 2.7 GHz)

3920B

1 kHz Offset: <-100 dBc/Hz (RF ≤500 MHz)
<-96 dBc/Hz (RF >500 to ≤1000 MHz)
<-90 dBc/Hz (RF >1000 to ≤2600 MHz)

10 kHz Offset: <-110 dBc/Hz (RF ≤500 MHz)
<-106 dBc/Hz (RF >500 to ≤1000 MHz)
<-95 dBc/Hz (RF >1000 to ≤2600 MHz)

RF GENERATOR (CONT)

B.1.4 Modulation

B.1.4.A Selections

OFF, AM, FM, FM 50 μ s, FM 75 μ s, FM 750 μ s, AM USB, AM LSB

B.1.4.B Internal FM

B.1.4.B.1 RF Range (Usable from 100 kHz)

10 MHz to 1.05 GHz (3901, 3920, 3920B Standard)

*3920B refer to Phase Noise Specifications for freq >1.0 GHz

10 MHz to 2.7 GHz (3902, 3920, 3920B Freq Extension Option [390XOPT058])

B.1.4.B.2 Deviation

± 0.001 to ± 150 kHz, OFF

B.1.4.B.3 Accuracy

3% (From ± 1 kHz to ± 100 kHz deviation, 20 Hz to 15 kHz rate)

B.1.4.B.4 Resolution

1 Hz

B.1.4.B.5 Deviation Rate

20 Hz to 15 kHz

B.1.4.B.6 Waveform

Sine, Square, Triangle, Ramp, Digital Coded Squelch (DCS), Dual Tone Multiple Frequency (DTMF)

B.1.4.B.7 THD

<1% (1 kHz rate, 6 kHz deviation, 300 Hz to 3 kHz BW, Sine)

RF GENERATOR (CONT)

Modulation (cont)

B.1.4.C Internal AM

B.1.4.C.1 RF Range (Usable from 100 kHz)

10 MHz to 1.05 GHz (3901, 3920, 3920B Standard)

*3920B refer to Phase Noise Specifications for freq >1.0 GHz

10 MHz to 2.7 GHz (3902, 3920, 3920B Freq Extension Option [390XOPT058])

B.1.4.C.2 Modulation Range

0% to 100%

B.1.4.C.3 Accuracy

1% (Modulation from 10 to 90%)

B.1.4.C.4 Resolution

0.1%

B.1.4.C.5 Rate

20 Hz to 15 kHz

B.1.4.C.6 Waveform

Sine, Square, Triangle, Ramp, Digital Coded Squelch (DCS), Dual Tone Multiple Frequency (DTMF)

B.1.4.C.7 THD

<1% (1 kHz rate, 30 to 70% AM, 300 Hz to 3 kHz BW, Sine)

B.1.4.D Internal Single-Sideband (SSB)

B.1.4.D.1 RF Range (Usable from 100 kHz)

10 MHz to 1.05 GHz (3901, 3920, 3920B Standard)

*3920B refer to Phase Noise Specifications for freq >1.0 GHz

10 MHz to 2.7 GHz (3902, 3920, 3920B Freq Extension Option [390XOPT058])

B.1.4.D.2 Modulation Selection

Upper-Sideband (USB) or Lower-Sideband (LSB)

B.1.4.D.3 Modulation Range

0% to 100%

B.1.4.D.4 Resolution

0.1%

B.1.4.D.5 Rate

300 Hz to 3 kHz

B.1.4.D.6 Waveform

Sine, Square, Triangle, Ramp, Digital Coded Squelch (DCS), Dual Tone Multiple Frequency (DTMF)

RF GENERATOR (CONT)

Modulation (cont)

B.1.4.E External AM/FM/SSB

B.1.4.E.1 Audio Inputs

With 1 Vrms, AM/FM/SSB have same characteristics as internal sources, $\pm 10\%$ of indicated setting.

Audio 1 or Audio 2 Input from 20 Hz to 15 kHz, (300 Hz to 3 kHz SSB), Unbalanced 8 Vrms maximum modulation input level.

B.1.4.E.2 Microphone Input

With 50 mVrms, AM/FM/SSB have same characteristics as internal sources, $\pm 10\%$ of indicated setting.

MIC Input from 100 Hz to 15 kHz (300 Hz to 3 kHz SSB)

B.1.4.F Internal I-Q (Option)

B.1.4.F.1 RF Range (Usable from 100 kHz)

10 MHz to 1.05 GHz (3901, 3920, 3920B Standard)

*3920B refer to Phase Noise Specifications for freq >1.0 GHz

10 MHz to 2.7 GHz (3902, 3920, 3920B Freq Extension Option [390XOPT058])

B.1.4.F.2 Modulation Selection

IQ Creator® file downloads for custom I-Q modulation

B.2 RF RECEIVER

B.2.1 Demodulation Selections

OFF, AM, FM, FM 50 μ s, FM 75 μ s, FM 750 μ s, AM USB, AM LSB

B.2.2 Frequency Range (Usable from 100 kHz)

10 MHz to 1.05 GHz (3901, 3920 Standard)

10 MHz to 2.7 GHz (3902, 3920 Freq Extension Option [390XOPT058])

B.2.3 Sensitivity

B.2.3.A Pre-Amp OFF

<-100 dBm (10 dB SINAD, FM, 25 kHz, 1 kHz rate, 6 kHz FM Deviation, 300 Hz to 3.4 kHz AF Filter)

B.2.3.B Pre-Amp ON

<-113 dBm (10 dB SINAD, FM, 25 kHz, 1 kHz rate, 6 kHz FM Deviation, 300 Hz to 3.4 kHz AF Filter, Pre-Amp On)

B.2.4 Selectivity

B.2.4.A IF Bandwidth

6.25, 8.33, 10, 12.5, 25, 30, 100, 300 kHz Filters

B.2.5 Demod Output Level

B.2.5.A FM

2.5 Vrms \pm 10% (for deviation \pm 1/2 of selected BW; 25 kHz BW same output level as 30 kHz BW)

B.2.5.B AM

2.25 Vrms \pm 10% (for 100% AM)

B.3 RF RECEIVE MEASUREMENTS

B.3.1 AM Meter

B.3.1.A Range

0% to 100%

B.3.1.B Scales

1% to 100% in a 1, 2, 5 sequence, plus Autoscale

B.3.1.C Resolution

0.1%

B.3.1.D Accuracy

±3% + source residual, ±1 count (30 to 90% AM, IF BW set appropriately for the received modulation bandwidth)

B.3.1.E AM

B.3.1.E.1 Rate

20 Hz to 15 kHz (IF BW set appropriately for the received modulation BW)

B.3.1.E.2 RF Range (Usable from 100 kHz)

10 MHz to 1.05 GHz (3901, 3920 Standard)

10 MHz to 2.7 GHz (3902, 3920 Freq Extension Option [390XOPT058])

B.3.1.E.3 RF Level

T/R: -10 to +50 dBm

ANT: -80 to +10 dBm

RF RECEIVE MEASUREMENTS (CONT)

B.3.2 FM Deviation Meter

B.3.2.A Range

0 to 150 kHz

B.3.2.B Scales

1 to 200 kHz in a 1, 2, 5 sequence, plus Autoscale

B.3.2.C Resolution

10 Hz

B.3.2.D Accuracy

±3% plus source residual, ±1 count (1 to 150 kHz FM deviation, IF BW set appropriately for the received modulation BW)

B.3.2.E FM

B.3.2.E.1 Rate

20 Hz to 20 kHz (IF BW set appropriately for the received modulation BW)

B.3.2.E.2 RF Range (Usable from 100 kHz)

10 MHz to 1.05 GHz (3901, 3920 Standard)

10 MHz to 2.7 GHz (3902, 3920 Freq Extension Option [390XOPT058])

B.3.2.E.3 RF Level

T/R: -10 to +50 dBm

ANT: -80 to +10 dBm

B.3.3 RF Counter

B.3.3.A Frequency

Range (Usable from 100 kHz, Autotune)

10 MHz to 1.05 GHz (3901, 3920 Standard)

10 MHz to 2.7 GHz (3902, 3920 Freq Extension Option [390XOPT058])

B.3.3.B Resolution

1 Hz

B.3.3.C Accuracy

Frequency Standard ± 1 count

B.3.3.D Level (Range)

T/R: -10 to +50 dBm (Find level is selectable)

ANT: -60 to +10 dBm (Find level is selectable)

RF RECEIVE MEASUREMENTS (CONT)

B.3.4 RF Error Meter

B.3.4.A Counter Range

0 to ± 2.5 MHz from Receiver frequency (6 MHz IF BW)

B.3.4.B Accuracy

Frequency Standard ± 1 count

B.3.4.C Resolution

1 Hz

B.3.4.D Level

T/R: -10 to +50 dBm

ANT: -60 to +10 dBm

B.3.5 Demodulation

B.3.5.A Demod Counter

B.3.5.A.1 Frequency

Range

20 Hz to 20 kHz (1 to 100 kHz FM Deviation, IF BW set appropriately for the received modulation BW)

20 Hz to 10 kHz (30% to 90% AM, IF BW set appropriately for the received modulation BW).

Resolution

0.1 Hz

Accuracy

± 50 ppm (± 10 ppm Typical)

B.3.5.A.2 Input Waveform

Sine or Square

B.3.5.A.3 RF Characteristics

Input RF (Usable from 100 kHz)

10 MHz to 1.05 GHz (3901, 3920 Standard)

10 MHz to 2.7 GHz (3902, 3920 Freq Extension Option [390XOPT058])

RF Level

T/R: -10 to +50 dBm

ANT: -80 to +10 dBm

RF RECEIVE MEASUREMENTS (CONT)

B.3.6 RF Power Meter (Broad band)

B.3.6.A Frequency

B.3.6.A.1 Range (Usable from 2 MHz)

10 MHz to 1.05 GHz (3901, 3920 Standard)

10 MHz to 2.7 GHz (3902, 3920 Freq Extension Option [390XOPT058])

B.3.6.A.2 Level

100 mW to 125 W (Usable from 10 mW)

B.3.6.A.3 Resolution

4 digits for W or 0.1 dB

B.3.6.A.4 Accuracy

10%, ± 1 digit

B.3.6.B Power Measurement Range

T/R: 100 mW to 125 W (25% on/off ratio)

B.3.7 RF Power Meter (In Band)

B.3.7.A Frequency

B.3.7.A.1 Range (Usable from 100 kHz)

10 MHz to 1.05 GHz (3901, 3920 Standard)

10 MHz to 2.7 GHz (3902, 3920 Freq Extension Option [390XOPT058])

B.3.7.A.2 Level

T/R: -60 to +51 dBm: Lowest reading is receiver BW dependent (Narrower bandwidths can measure lower levels).

ANT: -100 to +10 dBm: Lowest reading is receiver BW dependent (Narrower bandwidths can measure lower levels).

B.3.7.A.3 Resolution

0.1 dB

B.3.7.A.4 Accuracy (after User Calibration)

± 1 dB (Input Level above minimum for selected BW (display not yellow) typically better than ± 0.6 dB).

B.3.7.B AM Filter BW

6.25, 8.33, 10, 12.5, 25 and 30 kHz

B.3.7.C FM Filter BW

6.25, 10, 12.5, 25, 30, 100, and 300 kHz

B.4 AUDIO FUNCTION GENERATOR(S)

Up to 3 function generators can be combined into 1 Output signal

B.4.1 Waveshape

Sine, Square, Triangle, Ramp, Digital Coded Squelch (DCS), Dual Tone Multiple Frequency (DTMF)

B.4.2 Frequency

B.4.2.A Range

Sine: 20 Hz to 40 kHz (usable 1 Hz to 40 kHz)
Square: 20 Hz to 4 kHz (usable 1 Hz to 4 kHz)

B.4.2.B Resolution

0.1 Hz

B.4.2.C Accuracy

±50 ppm, ±10 ppm Typical

B.4.3 Level (Sine)

B.4.3.A Range

1 mV to 5 Vrms into a 10 kΩ load

B.4.3.B Resolution

0.1 mV

B.4.3.C Accuracy

±1% of setting (10 kΩ load)

B.4.4 Impedance

3901/3902: 600 Ω (nominal)

3920/3920B: <10 Ω

B.4.5 Spectral Purity

<0.5% (1 kHz, 5 Vrms, 80 kHz BW, 10 kΩ load, Sine)

<1.0% (Typical, 20 Hz to 40 kHz, 100 mV to 5 Vrms, 80 kHz BW, 10 kΩ load, Sine)

B.5 AUDIO & MODULATION MEASUREMENTS

B.5.1 AF Counter

B.5.1.A Frequency Range

20 Hz to 20 kHz (usable from 10 Hz)

B.5.1.B Resolution

0.1 Hz

B.5.1.C Accuracy

±50 ppm max, ±10 ppm Typical

B.5.1.D Waveshape

Sine or Square

B.5.1.E Input Level Range

3901/3902: 10 mV to 8 Vrms

3920/3920B: 10 mV to 30 Vrms

B.5.1.F Front Panel Inputs

Audio 1 or 2: Unbalanced, Chassis reference

Audio 1 and 2: Balanced, 600 Ω differential input

B.5.1.G Impedance

Hi-Z (>10 k Ω) Unbalanced input

600 Ω Unbalanced input (8 Vrms Maximum input*)

600 Ω Balanced input

*600 Ω Unbalanced input auto-switches to Hi-Z @ 8 Vrms (3920 only)

AUDIO & MODULATION MEASUREMENTS (CONT)

B.5.2 AF Level Meter

B.5.2.A Frequency Range

20 Hz to 20 kHz

B.5.2.B Accuracy

3901/3902: 5% (Unbalanced, Hi-Z, 300 to 3 kHz, 0.1 to 8 Vrms)

3920/3920B: 5% (Unbalanced, Hi-Z, 300 to 3 kHz, 0.1 to 30 Vrms)

B.5.2.C Level Range

3901/3902: 0 to 8 Vrms

3920/3920B: 0 to 30 Vrms

B.5.2.D Resolution

B.5.2.D.1 Volts

1 mV (Input <1 V)

10 mV (Input ≥1 V)

B.5.2.D.2 dBr, dBV, dBm

0.01 dB

B.5.2.E Scales

B.5.2.E.1 Volts

20 mV to 50 V in a 1, 2, 5 sequence, plus Autoscale

B.5.2.E.2 dBr

1 dBr to 100 dBr in a 1, 2, 5 sequence plus Autoscale

B.5.2.E.3 dBV

-40, -20, 0, 20, 40 dBV plus Autoscale

B.5.2.E.4 dBm

-30, -20, -10, 0, 10, 20, 30, 40 dBm plus Autoscale

B.5.2.F Front Panel Inputs

Audio 1 or 2: Unbalanced, Chassis reference

Audio 1 and 2: Balanced, 600 Ω differential input

B.5.2.G Impedance

Hi-Z (>10 kΩ) Unbalanced input

600 Ω Unbalanced input (8 Vrms Maximum input*)

600 Ω Balanced input

*600 Ω Unbalanced input auto-switches to Hi-Z @ 8 Vrms (3920 only)

AUDIO & MODULATION MEASUREMENTS (CONT)

B.5.3 SINAD Meter

B.5.3.A Range

0 to 60 dB

B.5.3.B Resolution

0.01 dB

B.5.3.C Accuracy

±1 dB, ±1 count (SINAD >3 dB, ≤40 dB, 5 kHz LP AF Filter)

B.5.3.D Signal Frequency

300 Hz to 5 kHz

B.5.3.E Signal Level

3901/3902: 0.1 to 8 Vrms

3920/3920B: 0.1 to 30 Vrms

B.5.3.F Front Panel Inputs

Audio 1 or 2: Unbalanced, Chassis reference

Audio 1 and 2: Balanced, 600 Ω differential input

B.5.3.G Impedance

Hi-Z (>10 kΩ) Unbalanced input

600 Ω Unbalanced input (8 Vrms Maximum input*)

600 Ω Balanced input

*600 Ω Unbalanced input auto-switches to Hi-Z @ 8 Vrms (3920 only)

AUDIO & MODULATION MEASUREMENTS (CONT)

B.5.4 Distortion Meter

B.5.4.A Range

0.0% to 100.0%

B.5.4.B Resolution

0.1%

B.5.4.C Accuracy

<±0.5% (Distortion 1% to 10%, 5 kHz LP AF Filter)
<±1.0% (Distortion 10% to 20%, 5 kHz LP AF Filter)

B.5.4.D Signal Frequency

300 Hz to 5 kHz (Entry Range 0 to 24,000 Hz)

B.5.4.E Signal Level

3901/3902: 0.1 to 8 Vrms
3920/3920B: 0.1 to 30 Vrms

B.5.4.F Front Panel Inputs

Audio 1 or 2: Unbalanced, Chassis reference
Audio 1 and 2: Balanced, 600 Ω differential input

B.5.4.G Impedance

Hi-Z (>10 k Ω) Unbalanced input
600 Ω Unbalanced input (8 Vrms Maximum input*)
600 Ω Balanced input
*600 Ω Unbalanced input auto-switches to Hi-Z @ 8 Vrms (3920 only)

AUDIO & MODULATION MEASUREMENTS (CONT)

B.5.5 Hum and Noise

B.5.5.A Modes

Mode	Stimulus	Stimulus Port	Measurement Input	Measurement Port
1	RF Generator	TR/GEN	AF Input	Audio In 1/2
2	AF Generator	Fctn Gen Out	RF Receiver	TR/ANT

B.5.5.B Meter Range

-100 to 0 dB

B.5.5.C Resolution

0.01 dB

B.5.5.D Accuracy

±1 dB, ±1 count (>-60 dB, ≤-20 dB)

B.5.5.E Signal Frequency

300 Hz to 5 kHz (Entry range 0 to 24,000 Hz)

B.5.5.F Audio Input Signal Level (Mode 1)

3901/3902: 0.1 to 8 Vrms

3920/3920B: 0.1 to 30 Vrms

B.5.5.G RF Level Input (Mode 2)

T/R: -10 to +50 dBm

ANT: -80 to +10 dBm

B.5.5.H Front Panel Inputs

Audio 1 or 2: Unbalanced, Chassis reference

Audio 1 and 2; Balanced, 600 Ω differential input

B.5.5.I Impedance

Hi-Z (>10 kΩ) Unbalanced input

600 Ω Unbalanced input (8 Vrms Maximum input*)

600 Ω Balanced input

*600 Ω Unbalanced input auto-switches to Hi-Z @ 8 Vrms (3920 only)

AUDIO & MODULATION MEASUREMENTS (CONT)

B.5.6 Signal to Noise Ratio

B.5.6.A Modes

Mode	Stimulus	Stimulus Port	Measurement Input	Measurement Port
1	RF Generator	TR/GEN	AF Input	Audio In 1/2
2	AF Generator	Fctn Gen Out	RF Receiver	TR/ANT

B.5.6.B Meter Range

0 to 60 dB

B.5.6.C Resolution

0.01 dB

B.5.6.D Accuracy

±1 dB, ±1 count (>3 dB, ≤40 dB, 5 kHz LP AF Filter)

B.5.6.E Signal Frequency

300 Hz to 5 kHz (Entry range 0 to 24,000 Hz)

B.5.6.F Audio Input Signal Level (Mode 1)

3901/3902: 0.1 to 8 Vrms

3920/3920B: 0.1 to 30 Vrms

B.5.6.G RF Level Input (Mode 2)

T/R: -10 to +50 dBm

ANT: -80 to +10 dBm

B.5.6.H Front Panel Inputs

Audio 1 or 2: Unbalanced, Chassis reference

Audio 1 and 2: Balanced, 600 Ω differential input

B.5.6.I Impedance

Hi-Z (>10 k Ω) Unbalanced input

600 Ω Unbalanced input (8 Vrms Maximum input*)

600 Ω Balanced input

*600 Ω Unbalanced input auto-switches to Hi-Z @ 8 Vrms (3920 only)

AUDIO & MODULATION MEASUREMENTS (CONT)

B.5.7 Audio Filters (Characteristic Response)

Filter	Type	Ripple	-1 dB	-60 dB
NONE	No Filter	--	--	--
300 Hz	Low-Pass	<0.23 dB, above 20 Hz	330 Hz	590 Hz
5 kHz	Low-Pass	<0.02 dB, above 20 Hz	5.5 kHz	6.7 kHz
15 kHz	Low-Pass	<0.01 dB, above 20 Hz	16.1 kHz	17.8 kHz
20 kHz	Low-Pass	<0.01 dB, above 20 Hz	20.4 kHz	21 kHz
0.3 to 3.4 kHz	Band-Pass	<1.7 dB	320 Hz/3.8 kHz	60 Hz/5.2 kHz
0.3 to 5 kHz	Band-Pass	<1.7 dB	320 Hz/5.2 kHz	60 Hz/9.6 kHz
0.3 to 15 kHz	Band-Pass	<1.7 dB	320 Hz/16.1 kHz	60 Hz/19.9 kHz
0.3 to 20 kHz	Band-Pass	<1.7 dB	200 Hz/20.4 kHz	60 Hz/21 kHz
PSOPH/C-MSG	Band-Pass	Per C-MSG Spec	Per C-MSG Spec	Per C-MSG Spec
PSOPH/CCITT	Band-Pass	Per CCITT Spec	Per CCITT Spec	Per CCITT Spec
300 Hz	High-Pass	<1.7 dB	320 Hz	60 Hz

B.6 CHANNEL ANALYZER

With the exception of the following, refer to Spectrum Analyzer Specifications for all other Channel Analyzer specifications.

B.6.1 Frequency

B.6.1.A Range (Usable from 100 kHz)

10 MHz to ± 2.5 MHz from Receiver Center Frequency within specified range
10 MHz to 1.05 GHz (3901, 3920 Standard)
10 MHz to 2.7 GHz (3902, 3920 Freq Extension Option [390XOPT058])

B.6.2 Span

B.6.2.A Width

2 kHz to 5 MHz

B.6.2.B Range

2 kHz to 5 MHz in a 1, 2, 5 sequence (Span may be entered numerically down to 1 Hz resolution)

B.6.3 Level

B.6.3.A Ref Level Range

± 60 dBm from measured Level within specified range
T/R: -50 to +50 dBm
ANT: -90 to +10 dBm

B.6.4 Resolution Bandwidth

B.6.4.A Selections

300 Hz, 3 kHz, 60 kHz

B.6.5 Sweep

B.6.5.A Frequency Sweep Time

50 ms to 100 s in a 1, 2, 5 sequence

B.7 RF SPECTRUM ANALYZER

B.7.1 Frequency

B.7.1.A Range (Usable from 100 kHz)

10 MHz to 1.05 GHz (3901, 3920 Standard)
10 MHz to 2.7 GHz (3902, 3920 Freq Extension Option [390XOPT058])

B.7.1.B Resolution

1 Hz

B.7.1.C Accuracy

Refer to Frequency Standard I/O Specifications

B.7.2 Span

B.7.2.A Mode

Start/Stop, Center/Span, Zero Span

B.7.2.B Width

2 kHz to full span

B.7.2.C Range

Selection is 2 kHz to Full Span in a 1, 2, 5 sequence, plus Zero Span (Span may be entered numerically down to 1 Hz resolution)

B.7.2.D Accuracy

±1% of span width

B.7.3 Display Accuracy

Span Accuracy + Freq Accuracy +50% of RBW

B.7.4 Markers

B.7.4.A Marker Accuracy

±1% of span width

B.7.4.B Track

Frequencies (or time) and amplitudes

B.7.4.C Number of Markers

Vertical Markers: 6
Horizontal Markers: 2

RF SPECTRUM ANALYZER (CONT)

Markers (cont)

B.7.4.D Marker Functions

Marker to Peak
Marker to Minimum
Marker to Center Frequency
Marker sets Vertical Scale (Zero Span only)
Marker to Next Right/Left
Marker to Ref Level
Marker sets Span

B.7.5 Level

B.7.5.A Ref Level Range

T/R: -50 to +50 dBm
ANT: -90 to +10 dBm

B.7.5.B Vertical Scales

1, 2, 5, 10 dB/division

B.7.5.C Reference Level Resolution

0.1 dB

B.7.5.D Ref Level Units

dBm, dB μ V, dBmV

B.7.5.E Dynamic Range

70 dB (Antenna, no attenuation, Ref Level -30 dBm, 30 kHz RBW)

B.7.5.F Bandwidth Switching Error

± 1 dB (After Normalize)

B.7.5.G Log Linearity

± 1 dB (RBW: 3 kHz, 30 kHz, 60 kHz, 300 kHz, 6 MHz)
 ± 1 dB (300 Hz RBW Typical)

B.7.5.H Accuracy

± 1 dB (Input signal -10 dB from Ref Level, Normalized, Pre-Amp OFF)

B.7.5.I Attenuator Selections

0 to 50 dB of attenuation, controlled by changing the Ref Level.

B.7.5.J 3rd Order Intermodulation

-60 dBc (Input Level of -30 dBm, Ref Level at -20 dBm)

B.7.5.K Harmonic Spurious

-55 dBc (Input Level of -30 dBm, Ref Level at -20 dBm)

RF SPECTRUM ANALYZER (CONT)

Level (cont)

B.7.5.L Non-Harmonic Spurious

-60 dBc (Input Level of -30 dBm, Ref Level at -20 dBm)

B.7.5.M Displayed Average Noise Level (DANL)

-125 dBm (Typical, 300 Hz RBW, ANT Port terminated, 20 sweep average)

B.7.6 Resolution Bandwidth

B.7.6.A Selections

300 Hz, 3 kHz, 30 kHz, 60 kHz, 300 kHz, 6 MHz

B.7.6.B RBW 60 dB/3 dB Filter Shape

>10:1

B.7.6.C Selectivity - Filter Shape

60 dB/3 dB ratio better than 10:1

B.7.6.D Accuracy

±10% of RBW for 3 kHz, 30 kHz, 60 kHz, 300 kHz

-10%/+25% of RBW for 6 MHz

±20% of RBW for 300 Hz

B.7.6.E Bandwidth Switching Error

±1 dB

B.7.7 Video Bandwidth

10 Hz to 1 MHz in a 1, 3, 10 sequence, NONE

B.7.8 Sweep

B.7.8.A Frequency Sweep Time

100 ms to 100 S in a 1, 2, 5 sequence

B.7.8.B Zero Span Sweep Time

50 ms to 100 S in a 1, 2, 5 sequence

B.7.8.C Sweep Trigger Source

Internal and External

B.7.8.D Trigger Modes

Continuous (Repeat), Single (Single-shot)

RF SPECTRUM ANALYZER (CONT)

B.7.9 Function/Feature

B.7.9.A Display Modes

Live, Average, Max Hold

B.7.9.B Averages

1 to 100

B.8 TRACKING GENERATOR (OPTION)

Reference RF Generator Specifications for 3920B Tracking Generator.

B.8.1 Tracking Generator Output

(measured at Center Frequency)

Refer to RF Signal Generator section for:

Frequency Range and Accuracy

Output Level Range, Resolution, Accuracy and Spectral Purity

B.8.2 Span and Sweep Time

Same as Spectrum Analyzer

B.8.3 Tracking Generator Controls

Output Port Selection, RF Level, Reference Call

B.9 OSCILLOSCOPE

B.9.1 Display

B.9.1.A Traces

2

B.9.1.B Trace Types

Live, Captured, Accumulated

B.9.1.C Markers

2

B.9.1.D Marker Functions

Time with Amplitude, deviation or % depth

Delta Marker (including $1/\Delta\tau$, e.g., Hz)

B.9.2 Vertical

B.9.2.A 3 dB Bandwidth

16 MHz

B.9.2.B Frequency Range

DC to 4 MHz (40 MS/s sampling rate)

B.9.2.C Input Range

0 to 100 V_{peak} maximum, Category I

B.9.2.D Scales

2 mV to 20 V/division in a 1, 2, 5 sequence (8(h) x 10 (w) graticule display)

B.9.2.E Accuracy

5% of full scale (DC to 1 MHz)

10% of full scale (1 to 4 MHz)

B.9.2.F Resolution

Better than 1% of full scale

B.9.2.G Coupling

DC, AC, GND

OSCILLOSCOPE (CONT)

B.9.3 Horizontal

B.9.3.A Sweep Factors

1 μ s to 1 Sec/division in a 1, 2, 5 sequence

B.9.3.B Accuracy

>1.5% of full scale

B.9.3.C Resolution

>1% of full scale

B.9.3.D Input Impedance

1 M Ω , 20 pF

1 M Ω , 20 pF

B.9.4 Trigger

B.9.4.A Trigger Source

Trace A, Trace B, EXT, (or Trace C with no CH1 or CH2 Input)

B.9.4.B Trigger Edge

Rising/Falling

B.9.4.C Trigger Mode

Auto/Normal

Continuous/Single

B.9.4.D External Trigger Level

Hi-Z BNC Input on the rear panel of the unit
Adjustable from -5 to +5 V

B.10 FREQUENCY STANDARD I/O

B.10.1 Internal Frequency Standard Output (OCXO)

B.10.1.A Frequency

10 MHz (nominal)

B.10.1.B Output Level

1 Vpp (Nominal) into 50 Ω

B.10.1.C Temperature Stability (0 to 50° C)

± 0.01 ppm

B.10.1.D Aging Rate

± 0.1 ppm/Year after 1 month continuous use.

B.10.1.E Warm Up Time

Less than 5 min. to ± 0.02 ppm

B.10.2 External Frequency Input

B.10.2.A Frequency

10 MHz

B.10.2.B Input Level

1 to 5 Vpp for Sine waves
3.3/5 V TTL for Square waves

B.10.2.C Connector

BNC socket (10 k Ω Input/50 Ω Output)

B.11 AUDIO SPECTRUM ANALYZER (OPTION)

B.11.1 Frequency Range

Start and Stop Frequency: 0 to 24,000 Hz

B.11.2 Resolution

1 Hz

B.11.3 Accuracy

±50 ppm, ±10 ppm Typical

B.11.4 Span

2 kHz minimum to 24 kHz maximum

B.11.5 Level

Vertical Scales

1, 2, 5, 10, 20 dB per division

B.11.5.A Reference Level

0 dB Full Scale (dBr)

B.11.5.B Dynamic Range

Greater than 120 dB

B.11.5.C Accuracy

±1 dB from 300 Hz to 15 kHz

B.11.6 Markers

Number of Markers: 2

B.12 DIGITAL MULTIMETER (3920 ONLY)

B.12.1 AC/DC Voltmeter

B.12.1.A Full Scale Ranges

200 mV, 2 V, 20 V, 200 V, 2,000 V, Auto
(150 VAC RMS or VDC maximum input, Category II)

B.12.1.B Resolution

3 1/2 digits (2000 counts)

B.12.1.C Accuracy

DC: $\pm 1\%$ FS, ± 1 count
AC: $\pm 5\%$ FS, ± 1 count

B.12.1.D AC Volts Frequency Range

50 Hz to 20 kHz

B.12.2 AC/DC AM Meter

B.12.2.A Full Scale Ranges

200 mA, 2 A, 20 A, Auto
(20 A range uses optional external shunt connected to Voltmeter)

B.12.2.B Maximum Open Circuit Input Voltage

30 Vrms referenced to Common or Earth Ground, Category I

B.12.2.C Resolution

3 1/2 digits (2000 counts)

B.12.2.D Accuracy

DC: $\pm 5\%$ FS, ± 1 count
AC: $\pm 5\%$ FS, ± 1 count
AC Volts Frequency Range
50 Hz to 10 kHz

B.12.3 Ohm Meter

B.12.3.A Full Scale Ranges

200 Ω , 2 k Ω , 20 k Ω , 200 k Ω , 2 M Ω , 20 M Ω , Auto

B.12.3.B Resolution

3 1/2 digits (2000 counts)

B.12.3.C Accuracy

$\pm 5\%$ FS, ± 1 count

DIGITAL MULTIMETER (CONT)

B.12.4 External Shunt (Optional Accessory)

B.12.4.A Rating (Category I)

10 AMPS, 100 mV
20 AMPS, ON 1 minute, OFF 4 minutes

B.12.4.B Accuracy (18 to 28 degrees C)

DC to 10 kHz, $\pm 0.25\%$

B.12.4.C Temperature Coefficient

0.005 %/° C

B.13 INPUT/OUTPUT CONNECTORS

B.13.1 ANT (RF Input)

B.13.1.A Connector Type

TNC

B.13.1.B Function

Receiver Input (Input port)

B.13.1.C Impedance

50 Ω (nominal)

B.13.1.D VSWR (with Attenuation ≥ 10 dB):

Better than 1.44:1 (RF freq. <1.05 GHz)
 Better than 1.58:1 (RF freq. >1.05 GHz to <2.7 GHz)

B.13.1.E Input Protection

10 W with warning above +17 dBm (Remove power immediately when alarm sounds).

B.13.2 T/R (RF Input/Output)

B.13.2.A Connector Type

Type N

B.13.2.B Function

RF Power Input, Generator low-level Output (Input/Output Connector)

B.13.2.C Impedance

50 Ω (nominal)

B.13.2.D VSWR

Better than 1.2:1 (RF freq. <1.05 GHz)
 Better than 1.3:1 (RF freq. >1.05 GHz to <2.7 GHz)

B.13.2.E Input Protection

T/R RF Input Power On/Off:

Peak RF Power	Maximum Time On	Minimum Time Off
≤ 50 W	Continuous	--
>50 W, ≤ 125 W	30 seconds	2 minutes
>125 W, ≤ 200 W **	5 seconds**	5 minutes**

T/R RF Input Alarm Activation*:

Alarm	Temperature		Peak RF Power
ON	>100° C	OR	>125 W
OFF	<100° C	AND	<125 W

*Remove power from Test Set immediately if Overload Alarm triggers.

** Applies to 3920 only.

INPUT/OUTPUT CONNECTORS (CONT)

B.13.3 GEN (RF Output)

B.13.3.A Connector Type

TNC

B.13.3.B Function

Generator high-level Output (Output Connector)

B.13.3.C Impedance

50 Ω (nominal)

B.13.3.D VSWR (with level <0 dBm):

Better than 1.7:1 (RF freq. <1.05 GHz)

Better than 1.9:1 (RF freq. >1.05 GHz to <2.7 GHz)

B.13.3.E Input Protection

10 W with warning above +23 dBm (Remove power immediately when alarm sounds).

B.13.4 GPIB

B.13.4.A Connector Type

24 pin IEEE

B.13.4.B Function

IEEE-488.1-1997

B.13.5 Ethernet

B.13.5.A Connector Type

8 Position, RJ-45 100/10 Mbit/s

B.13.5.B Function

10/100 Base-T Network Connection

B.13.6 RS-232

B.13.6.A Connector Type

9-Pin, D-sub Male

B.13.6.B Baud Rates

300, 600, 1200, 2400, 4800, 9600, 19200, 38400, 57600, 115200

B.13.6.C Stop Bits

1 or 2

B.13.6.D Parity

Odd, Even, None

INPUT/OUTPUT CONNECTORS (CONT)

B.13.7 Video

B.13.7.A Connector Type

15-pin, D-sub, VGA

B.13.7.B Function

VGA for external monitor

B.13.8 IF Output

B.13.8.A Connector Type

BNC

B.13.8.B Function

10.7 MHz Receiver IF

B.13.8.C Output Level

Proportional to Receive Signal Level

B.13.9 MIC/Accessory

B.13.9.A Connector Type

8 position, Female DIN

B.13.9.B Function

Microphone connection, Modulation Input, Demod Output, PTT Operation

B.13.10 Parallel Port

B.13.10.A Connector Type

25 position, Female D-sub

B.13.10.B Function

Printer Interface

B.13.11 USB

B.13.11.A Connector Type

Twin USB Standard connection (Rear Panel)
Single USB Standard connection (Front Panel 3920 only)

B.13.11.B Function

USB Version 1.1 interface (Mouse enabled)

INPUT/OUTPUT CONNECTORS (CONT)

B.13.12 PS/2 Interfaces (3901/3902 only)

B.13.12.A Connector Type

Dual PS/2 Connectors

B.13.12.B Function

Keyboard interface

B.13.13 Test Port

B.13.13.A Connector Type

15 position, Female 3 Tier D-sub

B.13.13.B Function

Programmable I/O and voltage Output (optional interface)

B.13.14 Auxiliary IF Input

B.13.14.A Connector Type

High-density dual inline

B.13.14.B Function

External digital receiver input (optional interface)

B.14 ENVIRONMENTAL

B.14.1 Operating Temperature

0 to 50°C (Tested in accordance with MIL-PRF-28800F Class 3)

B.14.2 Warm-up Time

15 minutes

B.14.3 Storage Temperature

-40 to 71°C (Tested in accordance with MIL-PRF-28800F Class 3)

B.14.4 Relative Humidity

80% up to 31°C decreasingly linearly to 50% at 40°C
(Tested in accordance with MIL-PRF-28800F Class 3)

B.14.5 Altitude

4,000 m (13,123 ft) (Tested in accordance with MIL-PRF-28800F Class 3)

B.14.6 Shock and Vibrations

30 G Shock (Functional Shock)
5-500 Hz random vibrations
(Tested in accordance with MIL-PRF-28800F Class 3)

B.14.7 Use

Pollution Degree 2

B.14.8 EMC

3920/3920B: EN 61326, Class A

B.14.9 Reliability

>8,000 hour calculated MTBF (MIL-HDBK-217F, Notice 2)

B.15 SAFETY STANDARDS

3901/3902: UI 61010B-1, EN 61010-1, CSA C22.2 No. 61010-1
3920/3920B: UL 61010-1

B.16 DIMENSIONS AND WEIGHT

Height	Width	Depth
19.7 cm	35.6 cm	52.0 cm
7.75 in	14.0 in	20.5 in
Weight	16.5 kg (36.8 lbs)	

B.17 AC POWER REQUIREMENTS

B.17.1 Voltage

100 V to 120 VAC @ 60 Hz
220 V to 240 VAC @ 50 Hz

B.17.2 Power Consumption

Nominally 120 W (200 W Max)

B.17.3 Mains Supply Voltage Fluctuations

≤10% of the nominal voltage

B.17.4 Fuse Requirements

3 A, 250 V, Type F

B.18 GENERAL FEATURES

B.18.1 LCD Display

B.18.1.A Screen Size

6.4 in. diagonal

B.18.1.B Active Area

129.6 mm (h) x 97.44 mm (v)

B.18.1.C Resolution

640 x 480 pixels

B.18.2 Disk Storage (3901/3902 only)

3.5 inch Floppy Disk
Internal hard disk of 30 GB available for user storage

Appendix C - Fuse Replacement Instructions

STEP	PROCEDURE
------	-----------

1. Verify 3900 is OFF and AC Power is disconnected from Test Set.
2. Press inward on pressure clip to remove Fuse Carrier.

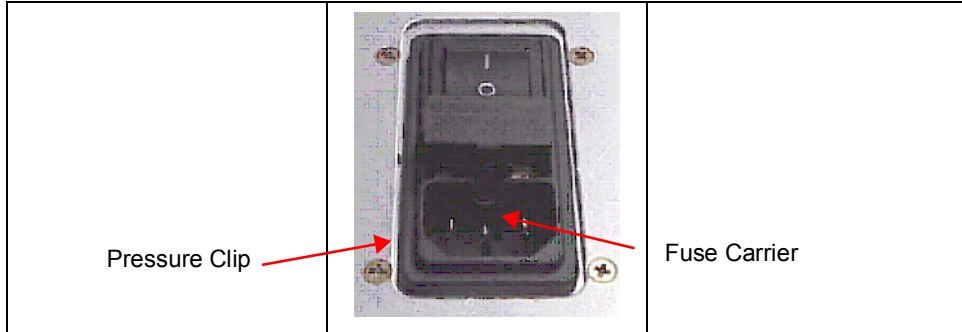

3. Remove Fuse Carrier from Test Set.



AC Fuse Carrier

4. Replace fuse:
3 A, 250 V, Type F
20 mm Cartridge Fuse (F3AL250V)
VIAVI P/N: 56078

CAUTION

FOR CONTINUOUS PROTECTION AGAINST FIRE, REPLACE FUSE WITH FUSES OF THE SPECIFIED VOLTAGE AND CURRENT RATINGS.

5. Install Fuse Carrier by pressing into place.
6. Install Fuse Cover.

Fuse Replacement Instructions

THIS PAGE INTENTIONALLY LEFT BLANK.

Appendix D - Abbreviations

Abs	Absolute
AC	Alternating Current
ACC	Accessory
AF	Audio Frequency
AGC	Automatic Gain Control
AM	Amplitude Modulation
Ana	Analog
ANT	Antenna
TETRA BS	TETRA Base Station
CF	Center Frequency
CH	Channel
CONFIG	Configuration
dB	decibel
dBm	decibel relative to 1 mW
dB_r	decibel relative to arbitrary reference value
dBV	decibel relative to 1 Volt
dBW	decibel relative to 1 Watt
dBV	decibel relative to 1 Micro Volt
DCS	Digital Coded Squelch
Dec	Decrements
Demod	Demodulated
TETRA DM	TETRA Direct Mode
DMM	Digital Multimeter
DTMF	Dual Tone Multiple Frequency
Dx	Duplex
EMF	Electromotive Force
ESD	Electro Static Discharge
Ext	External
FCTN	Function
Fig.	Figure
FM	Frequency Modulation
Freq	Frequency
fW	Femto Watt
GEN	Generator
GHz	Giga Hertz
GND	Ground
GPIB	General Purpose Interface Bus
GUI	Graphic User Interface
HPD®	High Performance Data®
Hz	Hertz
I/O	Input/Output
IF	Intermediate Frequency
Inc	Increments
kHz	Kilo Hertz

Abbreviations

kV	Kilo Volt
kW	Kilo Watt
LSB	Lower SideBand
LED	Light Emitting Diode
Meas	Measurements
MHz	Mega Hertz
MIC	Microphone
Mkr	Marker
Mod	Modulation
TETRA MS	TETRA Mobile Station
nW	Nano Watt
OPT	Option
PD	Potential Difference
Pk	Peak
Psoph	Psophometric
PTT	Push to Talk
pW	Pico watt
RBW	Resolution Bandwidth
RCI	Remote Command Interface
Res	Resolution
RF	Radio Frequency
RMS	Root Mean Square
RPM	RedHat Package Management
Rx	Receive
S	Seconds
SNR	Signal to Noise Ratio
SQ	Squelch
TL	Trigger Level
T/R	Transmit/Receive
Tx	Transmit
USB	Upper SideBand or Universal Service Bus
UTILS	Utilities
V	Volts
VBW	Video Bandwidth
VGA	Video Graphics Array
Vid	Video
VNC	Virtual Network Client
W	Watt
μs	Micro Seconds
μV	Micro Volt

Appendix E - Common Features Quick Reference Guide

The chart below identifies the Tile location or soft key used to access common settings and functions.

Setting	System	Field/Functions Location
AGC	Analog Duplex	Analyzers Tile (Level field)
	HPD®	RF Control Settings Tile
	TETRA Systems	RF Settings Tile or Control Tile
Calling Party SSI	TETRA Systems	Call Types Configuration Tile Messages Configuration Tile
Calling Party ESN	TETRA Systems	Call Types Configuration Tile
External Source	Analog Duplex	Generators Tile
	P25	Audio Configuration Tile
Factory Defaults (Restore)	All Systems	Store/Recall Utility Tile
Fan Control	All Systems	Operational Status Utility Tile
Frequency Reference	All Systems	Frequency Reference Utility Tile
Impedance	Analog Duplex	Analyzers Tile Generators Tile
	P25	Audio Configuration Tile
	TETRA Systems	Audio Test Tile
Loudspeaker	Analog Duplex	AF Measurements Configuration Tile Analyzers Tile Modulations Measurements Configuration Tile Ports Configuration Tile
	P25	Audio Configuration Tile
	TETRA Systems	Audio Test Tile
Pre-Amp	All Systems	Channel Analyzer Spectrum Analyzer
	Analog Duplex	Ports Configuration Tile Analyzers Tile
	HPD®	RF Control Settings Tile
	TETRA Systems	RF Settings Tile or Control Tile
MIC Phantom Power	Analog Duplex Only	AF Measurements Configuration Tile Mod Gen Configuration Tile Ports Configuration Tile
Output Port (FCTN GEN/Demod) Use	Analog Duplex	Modulation Measurements Configuration Tile Generators Tile Ports Configuration Tile
	P25	Audio Configuration Tile
PTT Controls RF Out	Analog Duplex Only	RF Gen Configuration Tile
PTT Polarity Active	Analog Duplex Only	RF Gen Configuration Tile

Setting	System	Field/Functions Location
Psoph Filter/Filter	Analog Duplex	AF Measurements Configuration Tile Analyzers Tile Modulations Measurements Configuration Tile
	P25	Audio Configuration Tile
	TETRA Systems	Audio Test Tile
Reset Overload Protection	All Systems	User Calibration Utility Tile Frequency Reference Utility Tile
Resolution (Frequency Counter)	Analog Duplex	Analyzers Tile
	TETRA Systems	Audio Test Tile
RS-232 Port/Baud Rate	P25	Ports Configuration Tile
SINAD/Distortion Frequency	Analog Duplex Only	AF Measurements Configuration Tile
SINAD/Distortion Width	Analog Duplex Only	AF Measurements Configuration Tile Modulation Measurements Configuration Tile
Source (Signal)	Analog Duplex	AF Measurements Configuration Tile Analyzers Tile Mod Gen Configuration Tile
	P25	Audio Configuration Tile
	TETRA Systems	Audio Test Tile
Warnings Pop-Ups	All Systems	Error List Utility Tile

Appendix F - Optional Test Systems and Functions

The following are Optional Systems currently available for the 3900 Series:

Option	Features Provided	Option #	Special Notes
Site Monitoring Application	Provides the ability to continuously monitor and log a radio system's receiver performance, including SINAD sensitivity and spectrum analysis.	390XOPT051	
IQ Gen Modulation	Provides users with the ability to download and modulate IQCreator® waveform files to the 3900.	390XOPT054	
Audio Analyzer	Provides the ability to evaluate the audio frequency band of a demodulated or externally input signal.	390XOPT055	
2.7 GHz Frequency Range	Extends upper frequency range of 3920 Test Set to 2.7 GHz.	390XOPT058	Only applicable to 3920 models
Harmonics & Spurious Measurements	Allows user to sweep a radio's transmitter and display the current fundamental transmit frequency and the level for the fundamental, second and third harmonic frequencies.	390XOPT060	Only available for Analog Duplex system. Transmitter level must be +20 dBm or higher.
Tracking Generator	The Tracking Generator generates a carrier wave that is applied to components or systems, which allows the output to be analyzed to evaluate the frequency response of the device under test.	390XOPT061	
Analyzer OBW & Power Between Markers	Displays the total power level of the received signal between markers and OBW on the Spectrum and Channel Analyzer Tiles.	390XOPT064	
POCSAG Testing Option	The POCSAG Testing Option provides users with the ability to test a pager's transmit and receive operation.	390XOPT067	
Chinese GUI	Displays User Interface content in Chinese. NOTE: Documentation and Help content is not supported in Chinese.	390XOPT090	
TETRA MS	Provides features for testing most functions of TETRA Mobile Stations (hand sets).	390XOPT110	
TETRA MS T1	Provides features for testing RF aspects of TETRA Mobile Stations (hand sets) using the TETRA T1 Test facility.		Included with TETRA MS Option
TETRA BS	Provides features for testing TETRA Base Station transmitters.	390XOPT111	
TETRA BS T1	Provides features for testing RF aspects of TETRA Base Station transceivers using the TETRA T1 Test facility.		Included with TETRA BS Option

Optional Test Systems and Functions

Option	Features Provided	Option #	Special Notes
TETRA DM	Provides features for testing TETRA Mobile Direct Mode call setup and parameters.	390XOPT112	
TETRA Energy Economy Mode	Provides features for selecting a specific energy economy mode to enable the Test Set to operate in a power saving capacity when communicating with a mobile.	390XOPT114	Requires 390XOPT110
TEDS (BST4 / MST4)	Provides features for testing TETRA BS T4 and TETRA MS T4 systems.	390XOPT117	
P25 Conventional	Provides the ability to transmit and receive P25 modulated signals and to perform RF and modulation measurements on P25 radios and systems.	390XOPT200	
P25 DES Encryption	Supports encoding and decoding of Data Encryption Standard data exchanged between P25 radios.		Included in 390XOPT200
P25 Trunking	Provides features for testing all bands of Trunked P25 radios and systems.	390XOPT201	Requires 390XOPT200
P25 800 MHz Bands	Supports P25 radio and system testing in 800 MHz frequency band.		Included in 390XOPT201
P25 700 MHz/UHF/VHF Bands	Supports P25 radio and system testing in 700 MHz, UHF and VHF frequency bands.		Included in 390XOPT201
P25 Trunked Base Station Simulator	Provides P25 Trunked Base Station functionality for testing P25 mobile radios.		Included in 390XOPT201
P25 LSM Generate/Receive Analysis	Provides features for testing Motorola® Linear Simulcast Modulation and enables EVM Meter and CQPSK Modulation.	390XOPT204	Requires 390XOPT200
P25 Channel Logger	The P25 Channel Logger allows XML formatted information to be relayed to and from a remote PC location and a Test Set.	390XOPT206	Requires applicable P25 Options Requires XML Viewing Application
SmartNet™/SmartZone™	The 3900 SmartNet™/SmartZone™ Option provides test features necessary to test SmartNet™/SmartZone™ radios and systems. Includes SmartNet™/SmartZone™ Channel Logger.	390XOPT207	Requires 390XOPT200
P25 KVL Loader	The KVL Keyloader Option adds the ability to enter encryption keys into the 3900 for DES and AES.	390XOPT209	DES requires 390XOPT200 AES requires 390XOPT240
Simulcast Audio Analysis	This option adds an Audio Tracking Generator to the Analog Duplex Audio Analyzer.	390XOPT210	Requires 390XOPT055
P25 Explicit Mode UHF/VHF	Enables all bands for P25 Trunking Explicit Mode of operation.	390XOPT212	Requires 390XOPT200 and 390XOPT201
P25 Unit to Unit Calling	Provides the ability to configure unit to unit calls.	390XOPT213	Requires 390XOPT200, 390XOPT201 and 390XOPT212

Optional Test Systems and Functions

Option	Features Provided	Option #	Special Notes
P25 Adjacent Status Broadcast Messages	Provides the ability to configure repeater control channel messages.	390XOPT214	Requires 390XOPT200 and 390XOPT201
P25 Secondary Control Channel Broadcast Messages	Provides the ability to configure repeater messages (SCCB and SCCB_EXP) to define the parameters of two secondary control channels.	390XOPT215	Requires 390XOPT200, 390XOPT201 and 390XOPT212
X2-TDMA® Base Station & Parametrics	Enables features for testing the performance of Motorola ASTRO® 25 X2-TDMA Mobile Radios.	390XOPT219 (R2124A)	Requires 390XOPT200 and 390XOPT201 Only available through Motorola.
P25 Phase 2 Test Protocol	Provides the ability to evaluate radio performance for P25 Phase 2 radio systems.	390XOPT220	Requires 390XOPT200
P25 OAM (Off Air Monitor) Software	Computer Application which provides the ability to capture and view P25 messages sent over the air.	390XOPT230	Requires 390XOPT200, 390XOPT206 and computer
P25 AES Encryption	Supports encoding and decoding of Advanced Encryption Standard data exchanged between P25 radios.	390XOPT240	Requires 390XOPT200
X2-TDMA® Mobile Emulation	Enables features for testing the performance of Motorola ASTRO® 25 X2-TDMA Base Radios.	390XOPT245 (R2123A)	Requires 390XOPT200 and 390XOPT201 Only available through Motorola
P25 Occupied Bandwidth Meter	Provides the ability to evaluate the Occupied Bandwidth measurement of a received signal.	390XOPT250	Requires 390XOPT200
P25 Performance Testing	Option enables boundary triggers which can be used for evaluating the timing of the radio's receive path.	390XOPT260	Requires 390XOPT200
X2-TDMA® Testing Suite	Includes X2-TDMA® Base Station & Parametric and X2-TDMA® Mobile Emulation option.	390XOPT261 (R2122A)	Requires 390XOPT200 and 390XOPT201 Only available through Motorola
HPD Testing Option	Provides the ability to transmit and receive Motorola HPD modulated signals and to perform RF and modulation measurements on Motorola HPD radios and systems.	390XOPT300 (R2091A)	Only available through Motorola
HPD Advanced Analysis Package	Provides the additional test and measurement capabilities for Motorola HPD modulated signals and additional data analysis operation.	390XOPT301 (R2092A)	Requires 390XOPT300 Only available through Motorola
HPD Testing Suite	Includes both HPD Testing Option and HPD Advanced Analysis Package.	390XOPT302 (R2093A)	Only available through Motorola
DMR Test Option	The Digital Mobile Radio option provides features for testing digital two-way radio systems.	390XOPT400	
DMR Channel Logger	The DMR Channel Logger allows XML formatted information to be relayed to and from a remote PC location and a Test Set.	390XOPT402	Requires 390XOPT400 Requires XML Viewing Application
dPMR Test Option	The Digital Private Mobile Radio option provides features for testing digital two-way radio systems.	390XOPT420	

Optional Test Systems and Functions

Option	Features Provided	Option #	Special Notes
dPMR Channel Logger	The dPMR Channel Logger allows XML formatted information to be relayed to and from a remote PC location and a Test Set.	390XOPT422	Requires 390XOPT420 Requires XML Viewing Application
NXDN Test Option	The NXDN option provides features for testing digital two-way radio systems.	390XOPT440	
NXDN Channel Logger	The NXDN Channel Logger allows XML formatted information to be relayed to and from a remote PC location and a Test Set.	390XOPT441	Requires 390XOPT440 Requires XML Viewing Application
ARIB STD-T98 Test Option	The ARIB STD-T98 option provides features for testing digital two-way radio systems.	390XOPT460	
ARIB STD-T98 Channel Logger	The ARIB STD-T98 Channel Logger allows XML formatted information to be relayed to and from a remote PC location and a Test Set.	390XOPT461	Requires 390XOPT460 Requires XML Viewing Application
The 3900 currently supports the following AutoTest II Options			
AutoTest II	The AutoTest II option provides an interface between the Test Set's AutoTest System and remote command functionality.		
	AutoTest II Analog	390XOPT059	
	AutoTest II TETRA	390XOPT115	Requires applicable TETRA Option
	AutoTest II TEDS	390XOPT120	Requires TEDS Option (390XOPT117)
	AutoTest II P25	390XOPT218	Requires applicable P25 Option
	AutoTest II HPD	390XOPT303	Requires applicable HPD Option
	AutoTest II DMR	390XOPT401	Requires 390XOPT400
	AutoTest II dPMR	390XOPT421	Requires 390XOPT420
	AutoTest II NXDN	390XOPT441	Requires 390XOPT440
	AutoTest II ARIB STD-T98	390XOPT461	Requires 390XOPT460

Optional Test Systems and Functions

Option	Features Provided	Option #	Special Notes
The following are Optional Automated Test Scripts currently available for the 3900 Series:			
XTS™ 5000 Automatic Alignment	Option provides automated procedure for evaluating performance and aligning frequencies of XTS™ 5000 radio.	390XOPT600	Requires 390XOPT200, 390XOPT061 and 390XOPT218
XTS™ 3000 Automatic Alignment	Option provides automated procedure for evaluating performance and aligning frequencies of XTS™ 3000 radio.	390XOPT601	Requires 390XOPT200, 390XOPT061 and 390XOPT218
XTL Power Alignment	Add ability to test the Low Power range of XTL radios.	390XOPT602	Requires 390XOPT600 , 390XOPT218, 390XOPT061 and AC24011
LMR TIA-603 AutoTest	Option provides automated test procedure for evaluating the performance of LMR radios.	390XOPT603	Requires 390XOPT059
Motorola APX™ Series Autotest/Alignment	Option provides automated procedure for evaluating performance and aligning frequencies of APX™ series radios.	390XOPT604	Requires 390XOPT200, 390XOPT218, 390XOPT061 and AC24011
EF Johnson Radio Alignment	Option provides automated test procedure for evaluating the performance of EF Johnson 5100/5300 radios. High power mobiles (>50W) can be tested with the use of a 6dB/150W Attenuator (AC25059).	390XOPT606	Requires 390XOPT200, 390XOPT218 and 390XOPT061
BK DPHx Radio Alignment	Option provides automated test procedure for evaluating the performance of Bendix King DPHx series radios.	390XOPT607	Requires 390XOPT200, 390XOPT218 and 390XOPT061
Kenwood P25 TK-5X10G Series Radio AutoTest/Alignment	The Kenwood P25 TK-5X10G Series Radio AutoTest/Alignment Option provides users with automated test and alignment capabilities for evaluating Kenwood P25 TK-5X10G Series radios.	390XOPT608	Requires 390XOPT200, 390XOPT218 and 390XOPT061
MOTOTRBO Radio Series AutoTest/Alignment	Option provides users with automated test and alignment capabilities for evaluating MOTOTRBO Series radios.	390XOPT610	Requires 390XOPT400, 390XOPT401 and 390XOPT061
Motorola TETRA MS (MTP-850 Series) AutoTest	Option provides automated test procedure for evaluating the performance of Motorola TETRA MS MTP-850 series radios.	390XOPT611	Requires 390XOPT110, 390XOPT115 and 390XOPT054
Technisonics Type 1 Radio AutoTest/Alignment	The Technisonics Type 1 Radio AutoTest/alignment Option provides users with automated test and alignment capabilities for evaluating Technisonics Type 1 radios.	390XOPT614	Requires 390XOPT200, 390XOPT218 and 390XOPT061
Technisonics Type 2 Radio AutoTest/Alignment	The Technisonics Type 2 Radio AutoTest/alignment Option provides users with automated test and alignment capabilities for evaluating Technisonics Type 2 radios.	390XOPT615	Requires 390XOPT200, 390XOPT218 and 390XOPT061
Harris P7300, P5500, XG75 Series Autotest	Option provides automated test procedure for evaluating the performance of Harris P7300, P5500, XG75 series radios.	390XOPT616	Requires 390XOPT200, 390XOPT218 and 390XOPT061

Optional Test Systems and Functions

Option	Features Provided	Option #	Special Notes
DMR Repeater Autotest Software		390XOPT626	Requires 390XOPT400, 390XOPT401 and 390XOPT061
KNG 800 Series Autotest/Alignment	Option provides users with automated test and alignment capabilities for evaluating KNG 800 Series radios.	390XOPT627	Requires 390XOPT200, 390XOPT218 and 390XOPT061
Kenwood 5x20 Series Autotest/Alignment	Option provides users with automated test and alignment capabilities for evaluating Kenwood 5x20 Series radios.	390XOPT630	Requires 390XOPT200, 390XOPT218 and 390XOPT061
Kenwood NXDN Series Autotest/Alignment	Option provides users with automated test and alignment capabilities for evaluating Kenwood NXDN Series radios.	390XOPT631	Requires 390XOPT440, 390XOPT441 and 390XOPT061

Appendix G - Error Messages

G.1 COMMAND ERRORS

Command Error messages generate an immediate error message to warn users that they have attempted to perform an invalid operation. Command Error Messages are displayed for 3 seconds before they disappear.

G.1.1 Error Number -101

G.1.1.A "Invalid character"

Character entered is not valid for selected parameter.

G.1.2 Error Number -102

G.1.2.A "Syntax error"

Remote Command script uses functional elements not defined in IEEE Std 488.2 and the SCPI Syntax and Style Handbook. Test Set only supports functional elements defined in IEEE Std 488.2 and the SCPI Syntax and Style Handbook.

G.1.3 Error Number -103

G.1.3.A "Invalid separator"

An invalid separator character has been used in a Remote Command. i.g. use of “;” instead of “:”

G.1.4 Error Number -104

G.1.4.A "Data type error"

Remote Command script uses functional elements not defined in IEEE Std 488.2 and the SCPI Syntax and Style Handbook. Test Set only supports functional elements defined in IEEE Std 488.2 and the SCPI Syntax and Style Handbook.

G.1.5 Error Number -105

G.1.5.A "Get not allowed"

Query command is not permitted for specified parameter.

G.1.6 Error Number -108

G.1.6.A "Parameter not allowed"

Remote Command defines a parameter that is not valid in relation to the specified data field.

i.e., :SA:VERT:VDIV 1 2 contains one extra parameter; select either 1 or 2, not both.

G.1.7 Error Number -109

G.1.7.A "Missing parameter"

Remote Command is missing a required parameter. e.g. :SA:TRAC:AVER:VAL is missing the number of averages; correct format is :SA:TRAC:AVER:VAL 25.

G.1.8 Error Number -111

G.1.8.A "Header separator error"

Remote Command Header is not properly separated from program data. Command header must be separated from program data by "white space".

G.1.9 Error Number -113

G.1.9.A "Undefined header"

Issued Remote Command does not define action to be performed.
i.e., :SA:TRAC:AVER:VAL command must include "?" to define command as a query command or include a numeric value to define command as a set command.

G.1.10 Error Number -121

G.1.10.A "Invalid character in number"

Character entered is not valid for selected parameter.

G.1.11 Error Number -123

G.1.11.A "Exponent too large"

Number of digits entered exceeds maximum allowed.

G.1.12 Error Number -124

G.1.12.A "Too many digits"

Number of digits entered exceeds maximum allowed.

G.1.13 Error Number -128

G.1.13.A "Numeric data not allowed"

Selected parameter requires text data.

G.1.14 Error Number -131

G.1.14.A "Invalid suffix"

Invalid unit of measurement has been defined in relation to specified measurement.
i.e., specifying dBm as the unit of measurement for a frequency parameter.

G.1.15 Error Number -141

G.1.15.A "Invalid character data"

Text entered is invalid for selected parameter.

G.1.16 Error Number -144

G.1.16.A "Character data too long"

Text stream exceeds maximum allowed for selected parameter.

G.1.17 Error Number -148

G.1.17.A "Character data not allowed"

Selected parameter only accepts numeric entries.

G.1.18 Error Number -151

G.1.18.A "Invalid string data"

Remote Command contains error in data string.
i.e., :TBS:CONF:CHPL:NEW plan_name contains more than 20 characters permitted.

G.1.19 Error Number -158

G.1.19.A "String data not allowed"

Remote Command contains parameters not permitted in command script.
i.e., :TBS:CONF:CHPL:NEW defining Block 2 data when Block 2 has not been included (INCL) in Channel Plan.

G.1.20 Error Number -161

G.1.20.A "Invalid block data"

Block data defined in Remote Command is invalid.
i.e., exceeds channel range or channel spacing range.

G.1.21 Error Number -168

G.1.21.A "Block data not allowed"

Remote Command defines block data not applicable to defined command.

G.2 DEVICE SPECIFIC ERRORS

Device Specific Errors generate an immediate error message to warn users when the Test Set experiences an internal fault that results in operational failure or causes the Test Set to operate outside of product specifications. Persistent Device Specific Error messages are displayed until the cause of the error is resolved.

G.2.1 Error Number 301

G.2.1.A "User calibration required"

Ambient Temperature has exceeded limit for current User Calibration setting. Run User Calibration or change User Calibration Threshold on User Calibration Utils Tile.

G.2.2 Error Number -310

G.2.2.A "System error: Measurement processor halted"

Indicates internal hardware malfunction. Reboot Test Set. Contact VIAVI Customer Service if error persists.

G.2.2.B "System error: Protocol Processor halted"

Indicates internal hardware malfunction. Reboot Test Set. Contact VIAVI Customer Service if error persists.

G.2.2.C "System error: Transmit processor halted"

Indicates internal hardware malfunction. Reboot Test Set. Contact VIAVI Customer Service if error persists.

G.2.2.D "System error: Receive processor halted"

Indicates internal hardware malfunction. Reboot Test Set. Contact VIAVI Customer Service if error persists.

G.2.2.E "System error: Reference is UNLOCKED"

Test Set is not locked to reference. If External is selected, 10 MHz source must be present on External Reference I/O Connector.
If Internal is selected and error message is received, contact VIAVI Customer Service.

G.2.2.F "System error: Receiver synthesizers are UNLOCKED"

Test Set is not locked to reference. If External is selected, 10 MHz source must be present on External Reference I/O Connector.
If Internal is selected and error message is received, contact VIAVI Customer Service.

G.2.2.G "System error: Generator synthesizers are UNLOCKED"

Test Set is not locked to reference. If External is selected, 10 MHz source must be present on External Reference I/O Connector.
If Internal is selected and error message is received, contact VIAVI Customer Service.

G.2.3 Error Number -313

G.2.3.A "User Calibration memory lost"

Test Set lost internal calibration values. Re-Run user calibration. If problem persists contact VIAVI Customer Service.

G.2.4 Error Number -321

G.2.4.A "Out of memory"

Indicates internal hardware malfunction. Reboot Test Set. Contact VIAVI Customer Service if error persists.

G.2.5 Error Number -340

G.2.5.A "Calibration failed"

Received when User Calibration fails. Restore Factory defaults and re-run User Calibration. If fault continues, contact VIAVI Customer Service.

G.2.5.B "Generator Yig Calibration Failed"

Received when internal unstable Yig is detected. Restore Factory defaults and reboot Test Set. If fault continues, contact VIAVI Customer Service.

G.2.5.C "Receiver Yig Calibration Failed"

Received when internal unstable Yig is detected. Restore Factory defaults and reboot Test Set. If fault continues, contact VIAVI Customer Service.

G.2.5.D "Receiver & Generator Yig Calibration Failed"

Received when internal unstable Yig is detected. Restore Factory defaults and reboot Test Set. If fault continues, contact VIAVI Customer Service.

G.2.6 Error Number -341

G.2.6.A "Calibration Data Transfer Failed"

Indicates internal Calibration load malfunction. Reboot Test Set. Contact VIAVI Customer Service if error persists.

G.2.7 Error Number -342

G.2.7.A "User Calibration Transfer Failed"

Indicates internal Calibration load malfunction. Reboot Test Set. Contact VIAVI Customer Service if error persists.

G.2.8 Error Number -343

G.2.8.A "Rx DSP Calibration Transfer Failed"

Indicates internal Calibration load malfunction. Reboot Test Set. Contact VIAVI Customer Service if error persists.

G.2.9 Error Number -344

G.2.9.A "Tx DSP Calibration Transfer Failed"

Indicates internal Calibration load malfunction. Reboot Test Set. Contact VIAVI Customer Service if error persists.

G.2.10 Error Number -345

G.2.10.A "Scope Calibration Transfer Failed"

Indicates internal Calibration load malfunction. Reboot Test Set. Contact VIAVI Customer Service if error persists.

G.2.11 Error Number -346

G.2.11.A "Function Generator Calibration Transfer Failed"

Indicates internal Calibration load malfunction. Reboot Test Set. Contact VIAVI Customer Service if error persists.

G.2.12 Error Number -347

G.2.12.A "TCXO Calibration Transfer Failed"

Indicates internal Calibration load malfunction. Reboot Test Set. Contact VIAVI Customer Service if error persists.

G.2.13 Error Number -350

G.2.13.A "Queue overflow"

Indicates internal hardware malfunction. Reboot Test Set. Contact VIAVI Customer Service if error persists.

G.2.14 Error Number -360

G.2.14.A "Communication Error"

Indicates internal hardware malfunction. Reboot Test Set. Contact VIAVI Customer Service if error persists.

G.3 EXECUTION ERRORS

Execution Errors are generated immediately to warn users when the Test Set is unable to perform a requested action. Execution Error messages are displayed for 3 seconds before they disappear.

G.3.1 Error Number 221

G.3.1.A "Settings conflict"

Attempting to configure a setting that is currently invalid.
(.e., Trying to route a filtered audio signal to the speaker, but a filter is not selected/defined.

G.3.2 Error Number -222

G.3.2.A "Data out of range"

Value entered exceeds Test Set range. User must re-define value.

G.3.2.B "Data out of range:Value truncated"

Value exceeds maximum number of characters for specified field. Test Set automatically shortens string to fit within defined parameter.

G.3.2.C "Data out of range:Value ignored"

Value exceeds Test Set range. Test Set ignores value and retains previous setting.

G.3.2.D "Data out of range:Value clipped to upper level"

Value exceeds Test Set range. Test Set reduces upper level to maximum permitted value. i.e., maximum setting for Upper Limit Analog Duplex Depth measurements is 100%. Attempting to set to 101% generates this error message and Test Set sets value to 100%.

G.3.2.E "Data out of range:Value clipped to lower level"

Value exceeds Test Set range. Test Set reduces lower level to minimum permitted value. i.e., minimum setting for Lower Limit Analog Duplex Depth measurements is 0.0%. Attempting to set to a negative value generates this error message and Test Set sets value to 0.0%.

G.3.2.F "Data out of range: Value clipped to next upper level"

Value entered is higher than upper range of Test Set. Value is automatically set to highest available value.

G.3.3 Error Number 253

G.3.3.A "Corrupt media(memory)"

External media (computer) is corrupt.

G.3.4 Error Number 254

G.3.4.A "Media(memory) full"

External memory device (i.e., USB memory device) is full.

G.3.5 Error Number 256

G.3.5.A "File not found"

Test Set is unable to locate specified file.

G.3.6 Error Number 257

G.3.6.A "File name error"

File name is invalid. It may contain invalid characters or exceed maximum number of characters permitted for type of file.

G.4 QUERY ERRORS

Query Errors generate an immediate error message that warns users when the Test Set can not process an issued remote command.

G.4.1 Error Number 400

G.4.1.A "Query error"

Remote Command query is not able to be processed. Specified command does not support query function.

THIS PAGE INTENTIONALLY LEFT BLANK.

Appendix H - Tone Encoding/Decoding Frequency Mapping

Standard Tone Remote Frequencies	Relative Levels	Tone Duration
High Level 2175 Hz Guard Tone	10 dBm	120 ms
1950 Hz Transmit F1 Function Tone	0 dBm	40 ms
1850 Hz Transmit F2 Function Tone	0 dBm	40 ms
2050 Hz CTCSS Monitor Function Tone	0 dBm	40 ms
Low Level Guard Tone	-20 dBm	Continuous
Voice Peaks	0 to 5 dBm	--

Table H-1 Tone Remote Frequency Data

Tone Number/Type	Code Digit	Tone Frequency in Hz													
		ZVEI1	ZVEI2	ZVEI3	PZVEI	DZVEI	PDZVEI	CCIR1	CCIR2	PCCIR	EEA	Euro Signal	NATEL	EIA	MODAT
Tone 0	0	2400	2400	2200	2400	2200	2200	1981	1981	1981	1981	979.8	1633	600	637.5
Tone 1	1	1060	1060	970	1060	970	970	1124	1124	1124	1124	903.1	631	741	787.5
Tone 2	2	1160	1160	1060	1160	1060	1060	1197	1197	1197	1197	832.5	697	882	937.5
Tone 3	3	1270	1270	1160	1270	1160	1160	1275	1275	1275	1275	767.4	770	1023	1087.5
Tone 4	4	1400	1400	1270	1400	1270	1270	1358	1358	1358	1358	707.4	852	1164	1237.5
Tone 5	5	1530	1530	1400	1530	1400	1400	1446	1446	1446	1446	652.0	941	1305	1387.5
Tone 6	6	1670	1670	1530	1670	1530	1530	1540	1540	1540	1540	601.0	1040	1446	1537.5
Tone 7	7	1830	1830	1670	1830	1670	1670	1640	1640	1640	1640	554.0	1209	1587	1687.5
Tone 8	8	2000	2000	1830	2000	1830	1830	1747	1747	1747	1747	510.7	1336	1728	1837.5
Tone 9	9	2200	2200	2000	2200	2000	2000	1860	1860	1860	1860	470.8	1477	1869	1987.5
Group	A	2800	885	885	970	825/885	825	2400	2400	1050	1050	--	1995	2151	
	B	810	810		810	740	886	930	930	930	930		571	2433	
Reset	C	970	740		2800	2600	2600	2247	2247	2400	2400		2205	2010	
	D	885	680		885	885	856	991	991	991	991		2437	2292	
Repeat	E	2600	970	2400	2600	2400	2400	2110	2110	2110	2110	1062.9	1805	459	487.5
	F	680	2600		680	680		1055	1055		2247		2694	1091	
Tone Width (ms)		70±15	70±15	70±15	70±15	70±15	70±15	100±10	70±15	100±10	40±4	100	70	33±.5	40±5
Seq Length (ms)		350	350	350	350	350	350	500	350	500	200	600-700	350	165	280
Max Intertone Time (ms)		15	15	15	15	15	15	7.5	7.5	7.5	4			0	
Min Gap Before/Between Seq (ms)		140	140	140	140	140	140	290	290	290	100			33	
Encoder Tolerance		±1.5.	±1.5.	±1.5.	±1.5.	±1.5.	±1.5.	±8Hz	±8Hz	±8Hz	±1.			±.1.	
Must Decode BW		±1.5.	±1.5.	±1.5.	±1.5.	±1.5.	±1.5.	±1.	±1.	±1.	±1.			±16Hz	
Must Reject BW		±4.5.	±4.5.	±4.5.	±4.5.	±4.5.	±4.5.	±3.	±3.	±3.	±3.			NS	

Table H-2 Tone Sequential Single Frequency Codes & Timings

THIS PAGE INTENTIONALLY LEFT BLANK.



**Part of CD # 6047
Revision M0
Jan 2020**

VIAVI Solutions, Inc.

North America:	1.844.GO VIAVI / 1.844.468.4284
Latin America	+52 55 5543 6644
EMEA	+49 7121 862273
APAC	+1 512 201 6534
All Other Regions:	viavisolutions.com/contacts