

Test Guide to DAA Planning, Deployment, & Maintenance

Simplifying DAA deployment complexities with easy-to-use fiber, Ethernet and RF solutions

Introduction

The race is on for service providers to deliver Gigabit speeds with unprecedented service reliability. Cable operators are well-positioned today to compete with freshly-upgraded DOCSIS 3.1 networks, but as subscribers insatiable thirst for increased bandwidth continues to grow it is clear that significant architectural changes will be needed to keep up. Distributed access architectures (DAA) like Remote PHY hold the promise of cost-effectively enabling the smaller service group sizes needed to meet future demands while holding the line on hub space/power requirements. DAA deployment will not come without significant technical, organizational, and logistical challenges as early adopters have learned. This app note focuses on the network test, monitoring, and maintenance aspects of DAA deployments and was collected from discussions and partnerships with leading cable operators from around the globe.

Framework for Efficiently Operationalizing DAA

The diagram below provides a general framework to guide thoughts around planning for, deploying, and maintaining DAA nodes in your network. It should be looked at more as a menu than a recipe – not all items will apply in all cases but regardless it is a good starting point for planning your specific rollout. This framework was created and refined through close interaction with early-adopter MSO's of all sizes from around the globe and leading DAA network equipment vendors. While there is inevitably some variation from provider to provider, many of the general themes were quite similar across the board.

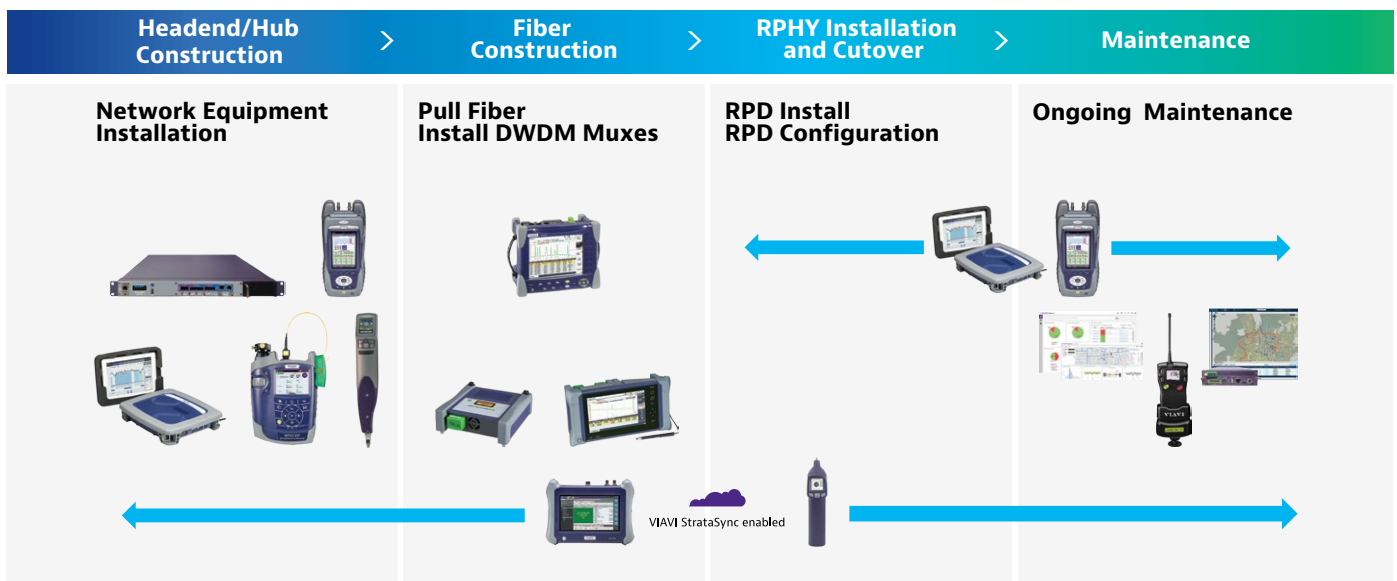

Note that the DAA deployment lifecycle above is broken into four distinct phases:

- Headend/Hub Construction – In this initial phase the service provision equipment and portions of the transport network are prepared to support primarily the inside plant segment of the DAA network.
- Fiber Construction – This phase generally occurs either after or in parallel with Headend/Hub construction. The focus here is characterizing existing fiber and deploying/testing/characterizing new fiber, muxes, and other optical components as needed to support the new network architecture.
- DAA Node Installation and Cutover – This phase is where the actual DAA node is physically installed, configured, tested, and services cutover.
- Maintenance – This includes activities that are needed to monitor, maintain, and troubleshoot DAA nodes after cutover. Note that this list may also include most of the tests included in previous sections as different types of problems emerge in normal network operation.

Headend and Hub Construction

This phase is all about ensuring that service provision equipment and supporting network infrastructure are prepared to support DAA nodes once deployed.

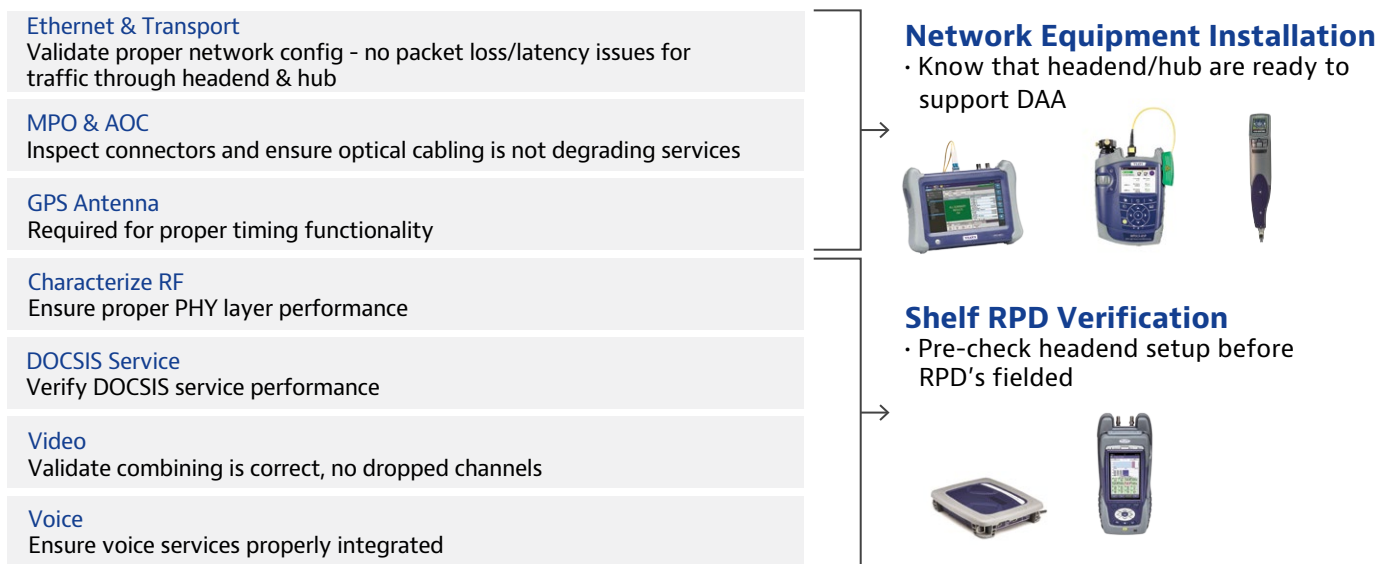

This phase can be divided into two primary sections:

- Network Equipment Installation
- Shelf RPD Verification

Network Equipment Installation can include physical installation and configuration of new CMTS/CCAP chassis. Some operators will take this opportunity to consolidate CCAP's and migrate them upstream into headends, with the ultimate longer-term goal of virtualizing them within data centers. This is also the point where leaf/spine architectures are sometimes introduced enhancing network efficiency and resiliency but also introducing new complexities. Besides testing the CCAP's themselves for proper functionality, the network interconnecting them must be tested to ensure no packet loss or latency issues.

- Basic Layer 3 Testing:
 - Connectivity
 - Ensure DHCP functionality, devices able to get IP addresses
 - Successful Ping
 - Quality
 - No frame loss at maximum throughput (typically 10G) – adequate to support DOCSIS/Video services at node
 - Characterize latency at turn-up state
 - Compare later to help detect congestion, PTP, other issues

As these changes occur and network functions virtualize and migrate upstream, headends start looking more like datacenters. This trend drove the adaptation of the telco CORD acronym (Central Office Rearchitected as a Datacenter) into HERD (Headend Rearchitected as a Datacenter) for cable. Two common datacenter technologies that have begun migrating into Cable are MPO (Multi-fiber Push-On) connectors and AOC (Active Optical Cables). Direct-attach copper cables (DAC) are the copper equivalent in that they have an active component to them.

Both allow operators to increase density primarily in headends but also improve efficiency. On the flip side both new-to-cable technologies also introduce testing challenges. MPO connectors are cumbersome to inspect without the right tools, and a single contaminant can take out multiple fibers due to their proximity within the connectors. With AOC's, cables now become active components and must be tested for performance/bit errors in addition to basic connectivity.

MPO inspection is critical to ensure cleanliness of bulkhead and the patch cord connectors, which can impact ORL/IL on all fiber paths. It is also important to test polarity of all links, adaptors, and patch cords to ensure no crossover issues. Application testing is also critical. MPO inspection is performed most efficiently using the FiberCheck Sidewinder, while polarity and application testing are best performed with the MPO-LX test set.

AOC/DAC testing is very similar to testing any other Ethernet link. Typical tests looking for BER and packet loss can be performed using a TB-5800 for AOC/DAC cables. They should not create BER above the 10^{-9} level. Single cables can be tested in a single pass, and breakout cables can be cycled through to cover all legs.

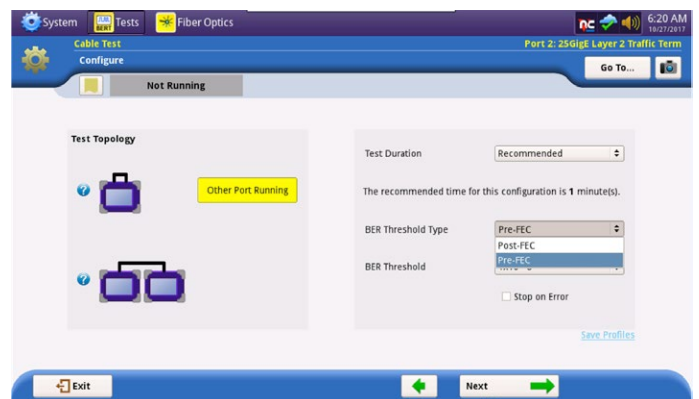

Network timing is critical to maintaining synchronization between RPD's and CMTS, especially for Remote PHY nodes which split the MAC and PHY layers sometimes at distance of 10's of km. PTP (Precision Timing Protocol) is the most common method used to maintain network sync for R-PHY nodes, but it can also be used for video/ audio sync in R-MACPHY nodes. Complete loss of PTP services are catastrophic especially for Remote PHY nodes as they will cease to operate but as a result are relatively easy to detect with the correct test gear. Less obvious are subtle shifts in PTP timing, networks may still function but will begin to experience BER. Without proper training and test capabilities these situations are impossible to diagnose for maintenance technicians and will likely result on excessive time chasing false symptoms and customer frustration.

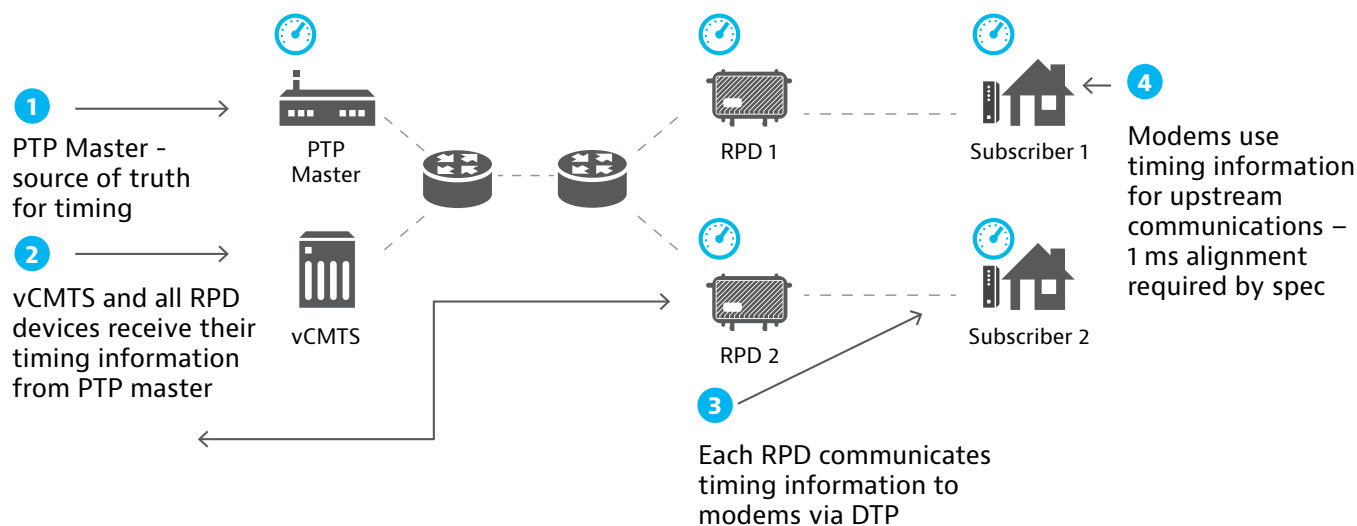

PTP Use in R-PHY

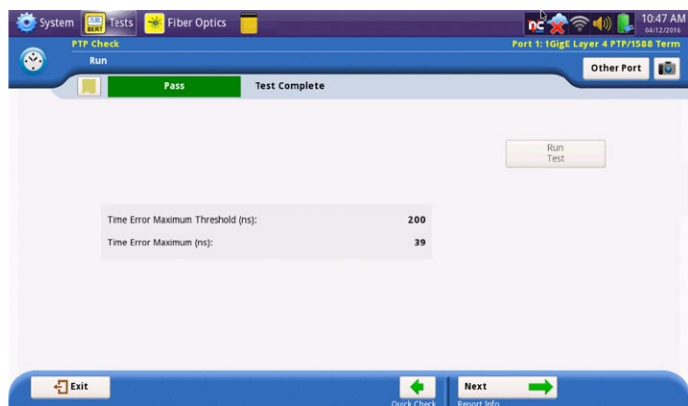
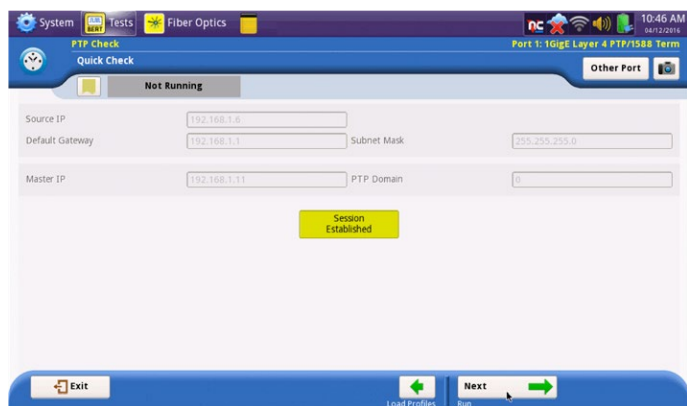

Test recovered clock accuracy based on the network path – critical for upstream DOCSIS spectrum

PTP timing relies on the GNSS satellite constellation as the ultimate source of truth, so a robust GPS antenna setup is critical to reliable operation. It is critical that the setup is tested to ensure that it is cabled properly, has a clear view of the satellites across time, and has a high carrier to noise ratio across the entire sky. Typically, a value of 40dBmV is adequate for reliable GPS operation. The VIAVI TB-5800 can automate these measurements, simplifying their execution for Tech's less familiar with how they work.

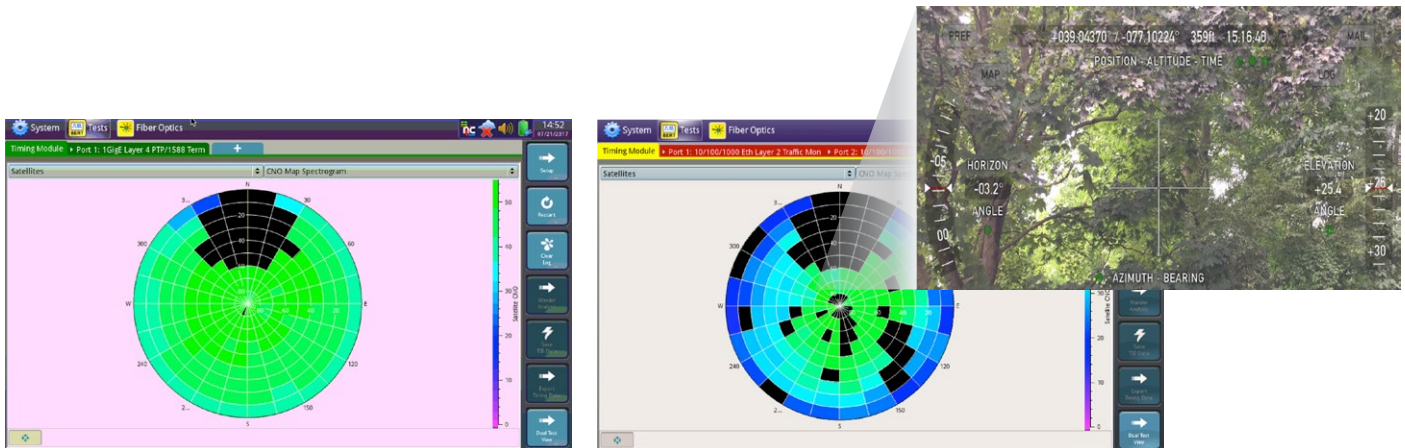

Shelf RPD Testing is sometimes used as a pre-check to verify that everything is ready from hub/headend/network standpoint to support future DAA node cutover. By turning up a sample DAA node within the headend, headend-based functionalities can be tested long before the first DAA node is sent out to the field for deployment. Video is a great example of a functionality that can't be thoroughly tested before turning up the first DAA node. When headend/hub changes are made in traditional networks a common verification practice is to connect a set top box at the output of the combining network and flip through the channels to verify that all are present and working. This is not possible with DAA because there is no RF present in the headend/hub to connect a set top box. Even if RF were available there would be nothing present to test—the video signal itself is created for the first time at the DAA node. Turning up a sample shelf DAA node allows verification of headend support for DOCSIS, video, and voice capabilities before calling the headend/hub construction phase complete.

- DOCSIS:

DOCSIS service/throughput testing at this point in the process should closely mimic what Tech's are doing in the field. The OneCheck Expert in the One Expert (ONX) CATV field meter is a simple method to check all necessary parameters in a single scripted test routine. Deep knowledge of the field meter is not required, with just a couple of clicks the ONX will set up and run predefined tests including full-lineup physical and service layer tests.

- Recommended tests

- SC-QAM: Level, hum, MER, BER, Echo, group delay, in-channel frequency response, tilt, transmit level, throughput, DQI over time
- OFDM: MER/subcarrier, signal level variation, ingress under QAM, PLC lock status/level/MER/CWE, NCP lock status/CWE, throughput
- Combined SC-QAM + OFDM: Bonding verification, combined throughput, packet loss/round trip delay/jitter

- Video:

DAA also significantly impacts video as in most cases the final video output is created on the DAA device itself and can't be tested farther upstream in the process. Ideally a field meter can be used to check for presence of all video carriers, ensure no BER, and validate correct program content by comparing MPEG PID's vs DSG program information. If an operator does not have field meters with this capability a set top box and TV can be used to spot check a few channels for shelf RPD verification, but this method will not scale well for field use as DAA deployments accelerate going forward. Alternatively, the VSE-1100 can be used to scan the entire downstream and display RF characteristics of video carriers, MPEG metrics, and validate program content per-channel.

- Voice:

It is also to confirm that VoIP services have been properly integrated during shelf-RPD verification, the simplest was to do this is to hook up a provisioned MTA and simply make a voice call. While this will not provide a MOS score or similar it will at least confirm that the service is present and functional. Additionally, VoIP SIP can be tested with an ONX field meter for deeper test capability if desired.

Fiber Construction Workflow

This phase focuses on ensuring that the fiber portion of the network is ready for DAA node installation and turnup. This phase naturally separates into the outside plant fiber characterization and DWDM-ready validation sections.

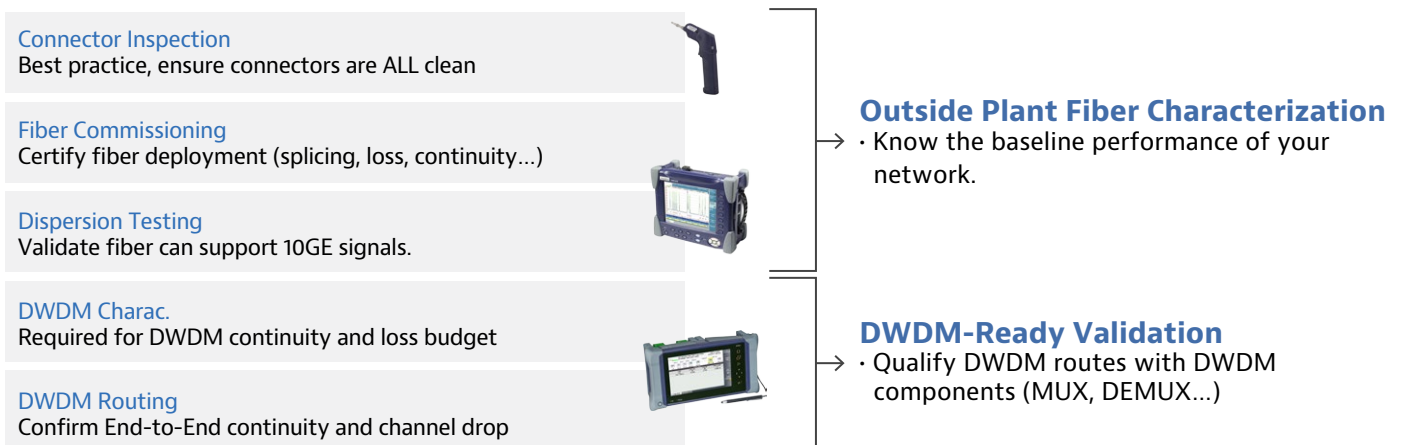

Anytime that fiber connectors are being connected cleanliness is of the utmost importance, multiple studies have shown that contaminated or damaged fiber end faces cause 80% or more of fiber-related networking issues. A single particle mated into the core of a fiber can cause significant back reflection, insertion loss, and even equipment damage. Operators should follow the ["Inspect Before You Connect"](#) process to ensure fiber end faces are clean prior to mating connectors.

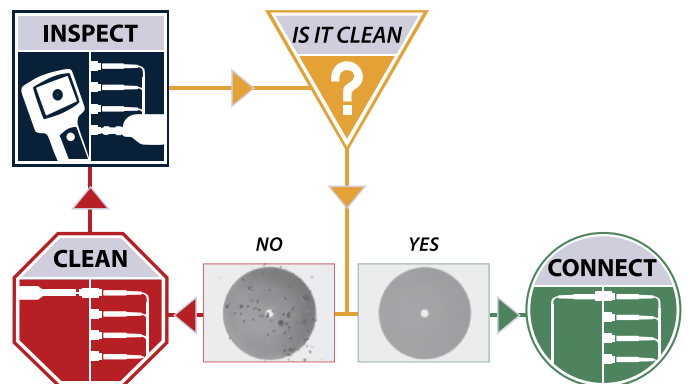

Outside Plant Fiber Characterization includes baselining optical characteristics for both new fiber being deployed and existing fiber. Just because fiber deployed 20 years ago has performed well with legacy low-speed analog signaling does not mean that it is capable of supporting services needed to support 5G and other higher-speed use models.

Full fiber characterization cannot be performed without taking a network out of service, and DAA deployment provides the perfect opportunity while the network is already being taken down to ensure that deployed fiber assets can deliver advanced services when needed in the future.

Typical Fiber Characterization tests may include:

Test Parameters	Measurement
Connector Inspection	Inspection Scope
Bi-directional Insertion Loss	Loss Test Set or Fiber Complete
Bi-directional Optical Return Loss (ORL)	Loss Test Set or FiberComplete
Bi-directional connectors/splice measurements	OTDR or FiberComplete
Distance Measurement	OTDR or FiberComplete
Reflectance Measurements	OTDR or FiberComplete
Polarization Mode Dispersion (PMD)	PMD Analyzer
Chromatic Dispersion (CD) measurement	CD Analyzer
Attenuation Profile (AP) measurements	Spectral Analyzer

Some of the testing may seem obvious (Insertion loss, optical return loss, reflectance), but the tighter Chromatic Dispersion (CD) and Polarization Mode Dispersion (PMD) specifications to support 10GE signaling reintroduces the need for dispersion testing. While counterintuitive, dispersion is generally not a problem for faster 100GE links as they often use coherent optics which are more robust to this problem. Min/Max for typical systems are listed below but can vary.

Transmission Type	Transport Speed	PMD Max	CD Max
SONET	OC-192/STM-64	10 picoseconds	1176 ps/nm
Ethernet	10 Gb/s	5 picoseconds	738 ps/nm
SONET	OC-768/STM-256	2.5 picoseconds	64 ps/nm
Ethernet Coherent	100Gb/s	25 picoseconds	30000 ps/nm
Ethernet Non Coherent	100Gb/s (4x25 Gb/s)	1.0 picoseconds	500 ps/nm

OTDR Test:

An [optical time-domain reflectometer \(OTDR\)](#) allows technicians to detect, locate, and measure events on fiber links such as mated connectors, splices, bends, ends and breaks, and the following properties can be measured by having access to only one end of the fiber (unidirectional testing):

- Attenuation – The optical power or signal loss or the rate of loss between two points along the fiber span.
- Event Loss – The difference in the optical power level before and after an event.
- Reflectance – The ratio of reflected power to incident power of an event.
- Optical Return Loss (ORL) – The ratio of the reflected power to the incident power for an optical link.

The VIAVI [SmartOTDR](#) allows technicians at any skill level to perform all essential fiber tests. The Smart Link Mapper (SLM) application displays each event as an icon, giving technicians a schematic view of the entire link, helping them use an OTDR more effectively, without the need to be able to interpret and understand OTDR trace based results.

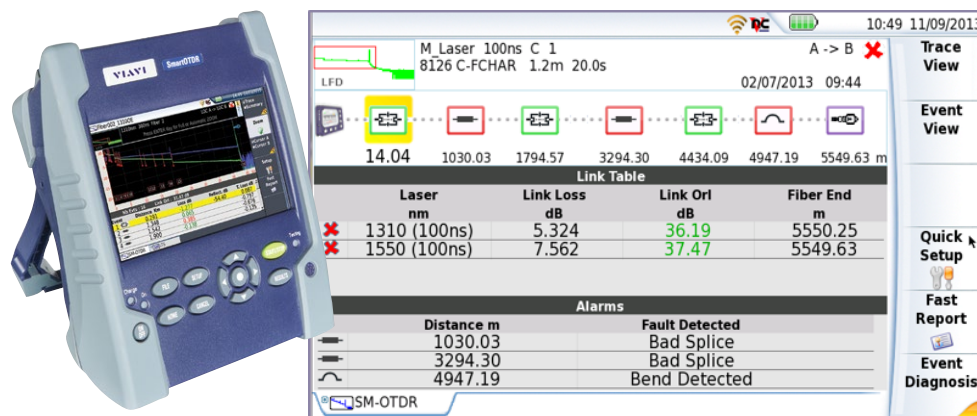

SmartOTDR and SmartLinkMapper application

In order to more accurately characterize fiber links and individual events, and to try to uncover additional events that may have been concealed by an OTDR's own dead zone performance when testing unidirectionally, dark fiber providers or the fiber owner/operator can perform [bi-directional tests](#). This allows for more accurate measurement of events (losses and reflections, etc.), there are situations due to fiber tolerances, mismatches or splicing that can result in excessive or differing optical losses (or apparent gains) when viewed from different directions.

Keep in mind you can never be 100% sure what direction of service a fiber will be used for when it is installed. A lot of applications are dual fiber with one Tx and one Rx fiber, but there are also single fiber implementations with different wavelengths being used for Tx and Rx on the same fiber in opposite directions.

For improved accuracy of OTDR results, it is highly recommended to perform bi-directional tests. This allows technicians to identify potential faults that might be hidden by OTDR dead zones. Bi-directional tests will certify fiber performance in both directions (remember PON fibers carry light in 2 directions, up and downstream). Automation of the bi-directional testing and reporting process, presenting results in an easier to read format (Smart Link Mapper), along with performing tests via a single test port will significantly reduce test time, improve test workflow and reduce complexity (i.e. the risk of mistakes and re-test). VIAVI FiberComplete solution automates bi-directional IL, ORL and OTDR fiber certification.

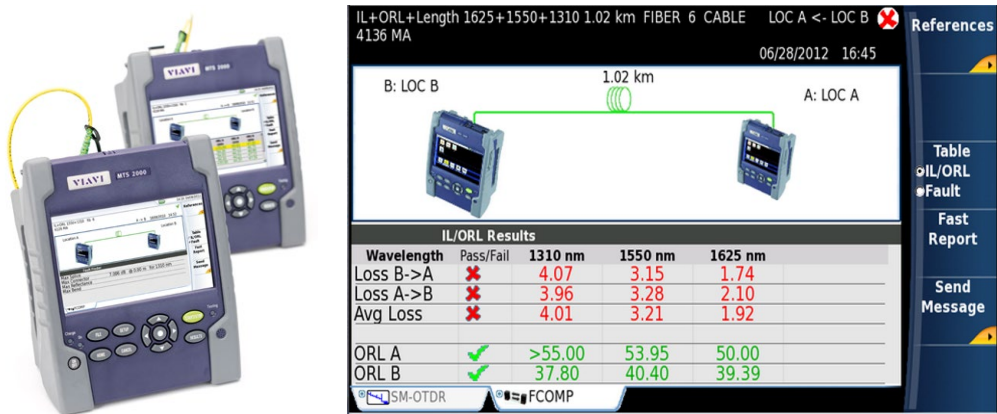

FiberComplete for T-BERD/MTS-2000, -4000 V2, -5800 V2

The Smart Link Mapper (SLM) application displays each event as an icon, giving technicians a schematic view of the entire link, helping them use an OTDR more effectively, without the need to be able to interpret and understand OTDR trace based results.

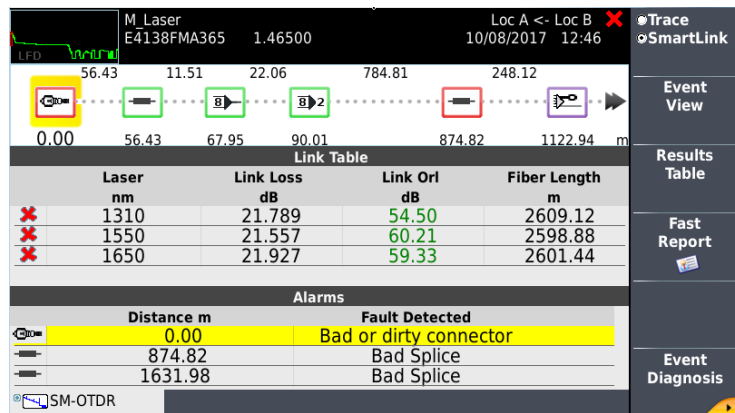

FTTH-SLM

VIAVI [FiberComplete™](#) is an all-in-one, automated and single test port solution that tests bi-directional insertion loss (IL), optical return loss (ORL), and OTDR.

Bidirectional Analysis

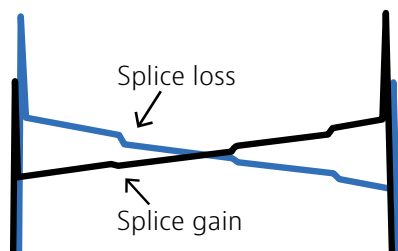

Fiber backscatter coefficient mismatches can cause a splice to appear as a gain or as a loss, depending upon the test direction.

Bidirectional analysis is used to minimize possible mismatches by measuring the splice loss in both directions and averaging the result to obtain the true splice loss.

FiberComplete application

The second portion of the Fiber Construction Workflow focuses on DWDM functionality. DWDM is frequently used in DAA deployments to better leverage existing deployed fiber as well enabling future revenue opportunities. Once individual fiber links have been characterized, end-to-end DWDM route validation is needed to ensure complete routes are within specification. DWDM OTDR's are required to test for end to end continuity, loss, etc through the MUX's/DEMUX's present across individual routes as well as full-channel testing across each MUX/DEMUX pair.

Link Qualification

WDM (Wavelength Division Multiplexing)

WDM allows service providers to increase capacity by adding new equipment at either end of a fiber strand and combine multiple wavelength/channels on a single fiber strand. Multiplexers are used to combine wavelengths onto a single fiber, and demultiplexers are used to separate the wavelengths at the other end. DWDM is most prevalent for modern DAA deployments but you may still see some of the legacy technologies in certain cases.

- 1. Coarse Wave Division Multiplexing (CWDM)**, provides up to 18 channels (or wavelengths) on a single fiber to allow for higher capacity. CWDM networks are typically passive with no active amplifiers in order to save cost and complexity and due to the wider channel spacings it can utilize cheaper components (SPF transceiver Tx/Rx, MUX/DeMUX and filters) which again makes it cheaper to deploy. Keep in mind that a key driver for access networks is price/cost. In addition, with only 18 channels it's easier to manage and maintain (there are only 18 variations of SFP to manage during deployment and maintenance). Passive CWDM is typically only used for distances up to 80km, however, for distances between 40 to 80km there can be a reduction in the number of usable channels to only the upper 8, this is because of the fiber's attenuation of wavelengths below 1470nm due to things like water peaks. The losses per wavelength across all the transmission bands are known as the fiber's attenuation profile (AP). The AP varies between fibers and fiber types and will partially dictate the number of useable channels which will have an impact on capacity scalability. Low water peak fiber has been available for some time but unless you are certain about the fiber in the ducts it is best to check. Ultimately for passive links the optical budget of the transceivers, passive element losses, splice/connector losses and the fiber's AP (i.e. optical loss per wavelength per km) will define the max link length achievable.

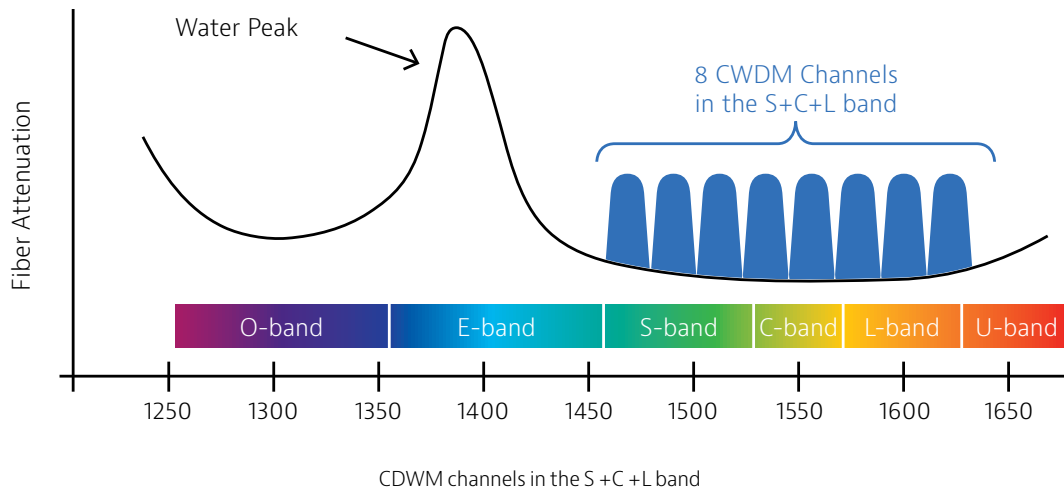

2. Dense Wave Division Multiplexing (DWDM), provides up to 96 channels per fiber depending on the spacing used. Spacing of 100 GHz is still the most common, but today's DWDM systems can support 50 GHz (0.4 nm) and even 25 GHz spacing with up to 160 channels is possible. To put this in perspective, CWDM has a spacing of 20 nm per channel. DWDM networks can be passive or active, which approach is used will depend mostly on the distances involved, current data requirements and future capacity need. As for passive DWDM the maximum distance for passive DWDM will depend on the transceiver's optical budget - DWDM ranges from ~1530 to 1570nm and the AP is consistent over this range.

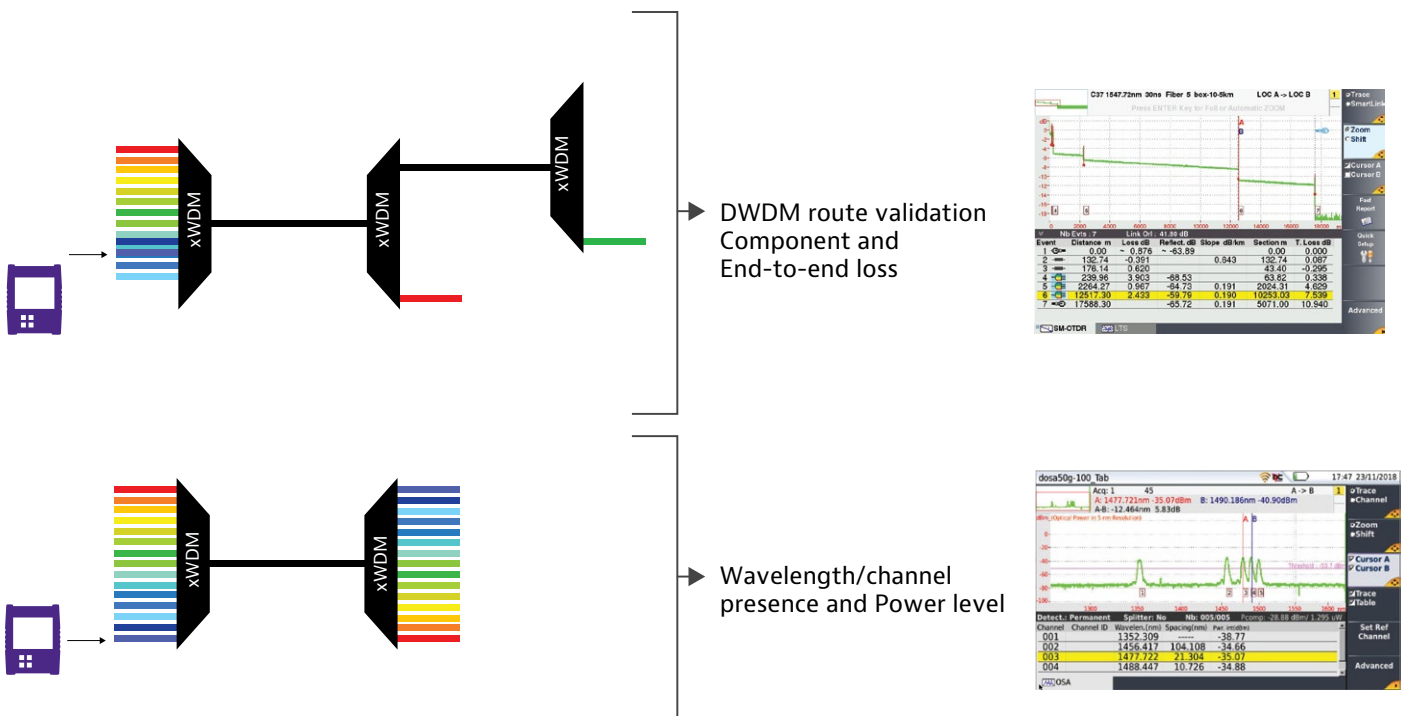

3. Hybrid CWDM & DWDM (xWDM), provides the possibility to expand the capacity of CWDM infrastructure by using an appropriate CWDM channel to accommodate multiple DWDM wavelengths. In this hybrid environment, the DWDM wavelengths typically use 100GHz spacing, this is for two reasons, firstly to allow for small drifts in transmitted wavelengths so filtering doesn't impact other services and secondly to keep the cost of transceivers, filters, and MUX/DeMUX to a minimum allowing for the utilization of cheaper components with wider tolerances.

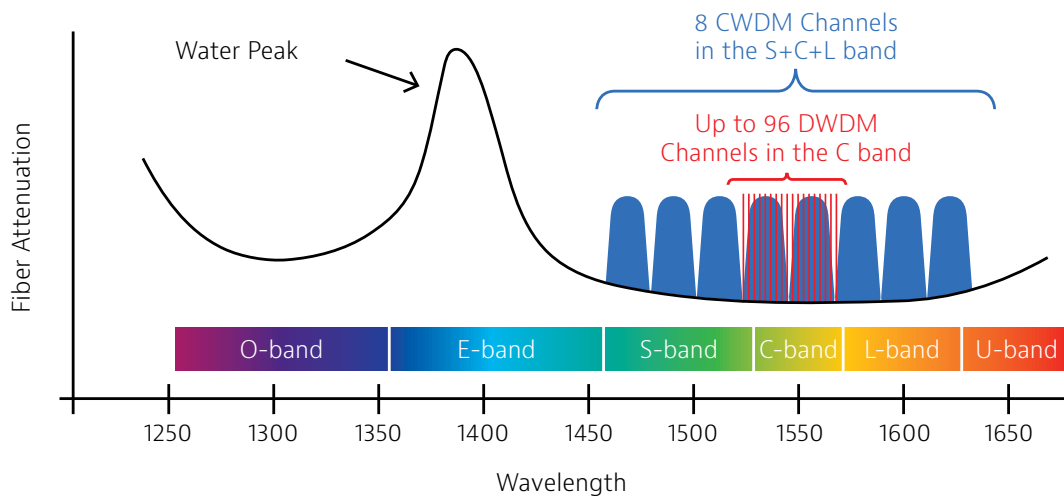

Hybrid CWDM and DWDM

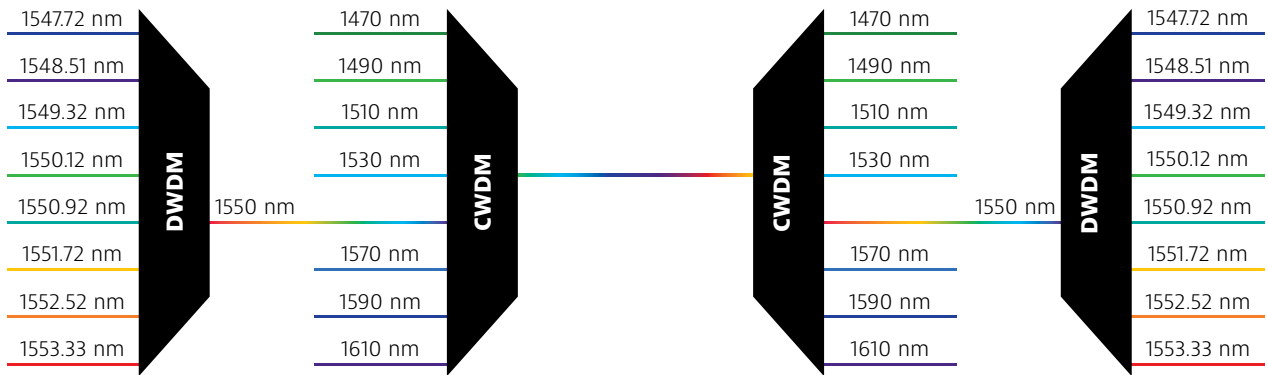

Example of 8 DWDM channels (100GHz spacing) added to an existing 8-channel CWDM network

xWDM-specific test challenges

It is expected that most of the fiber network infrastructure will be upgraded to take advantage of higher multiplexing technologies to offer higher throughput. However, testing xWDM networks is not so trivial, especially since DWDM channels are so close, DWDM transmitters require precise temperature control to maintain wavelength stability and operate properly, and wavelength filters must do their job of passing the correct wavelength while blocking others. This means that an issue with one channel could easily create issues with the channels on either side, making testing and maintaining DWDM networks more complex. DWDM networks must be tested for loss, connector cleanliness, and spectral quality. The following tests are essential for xWDM networks.

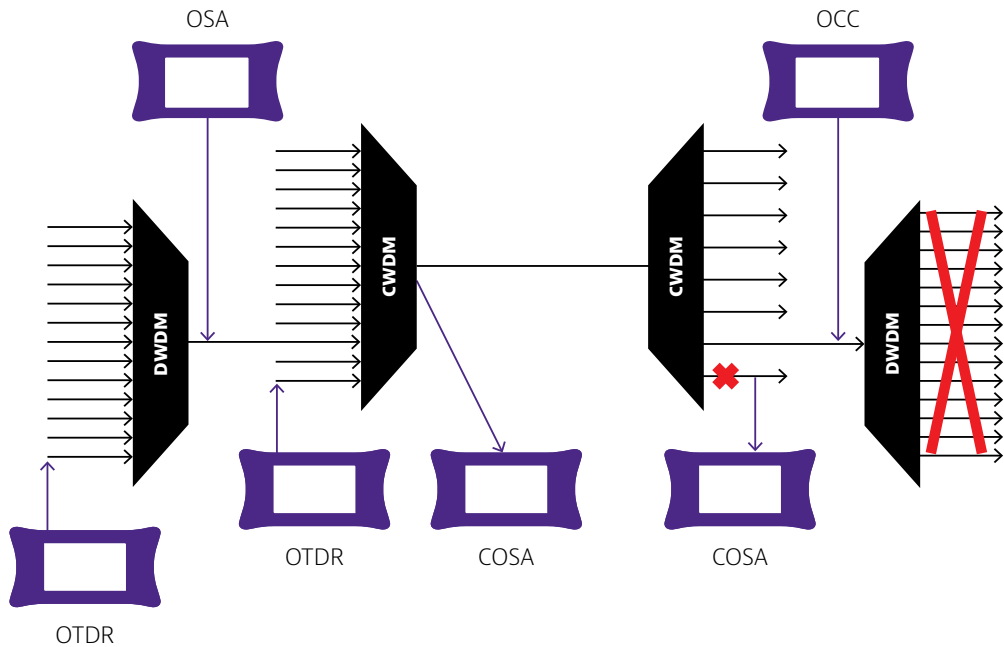

xWDM testing

WDM OTDR Test

A CWDM or DWDM OTDR such as the VIAVI 4100 series CWDM and DWDM OTDR modules, for the T-BERD/MTS-2000, 4000, 4000 V2, and 5800 V2 mainframes, can be used to validate a core fibers ability to transport all the xWDM wavelengths during build certification and prior to the connection of the WDM MUX/De-MUX. They can also be used after MUX/De-MUX connection to validate the end to end wavelength routing and losses for specific wavelengths or for maintenance and troubleshooting to expose and locate any bends, breaks, bad connectors or splices. Standard OTDRs using traditional 1310/1550nm wavelengths for test can't be used for this second level of testing due to the wavelength filtering implemented in the MUX/DeMUX devices.

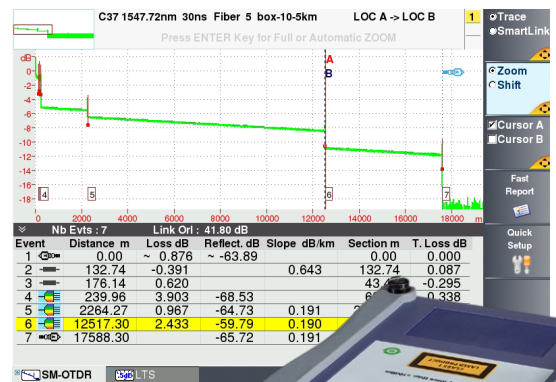

DWDM OTDR Module

Channel check

A CWDM or DWDM power meter (aka Optical Channel Checker (OCC)) can be used to perform basic checks for wavelength presence and power levels to validate correct wavelength routing.

A small form factor CWDM or DWDM optical spectrum analyzer/ optical channel checker, [COSA \(CWDM\)](#) and [OCC-4056C \(DWDM\)](#) 4100 series module for the T-BERD/MTS-2000, 4000, 4000 V2, and 5800 V2 mainframes, can also be used to perform the same wavelength presence and power level checks. However, with the added capability to report ITU-T channel numbers, technicians can quickly measure actual wavelength to check for drift or offset and report actual channel spacing (particularly important for DWDM). While dual integrated SFP bays allows technicians to verify wavelength/channel of colored and tunable SFPs which also provides the option to become a tunable light source which can be used for link routing/insertion loss test.

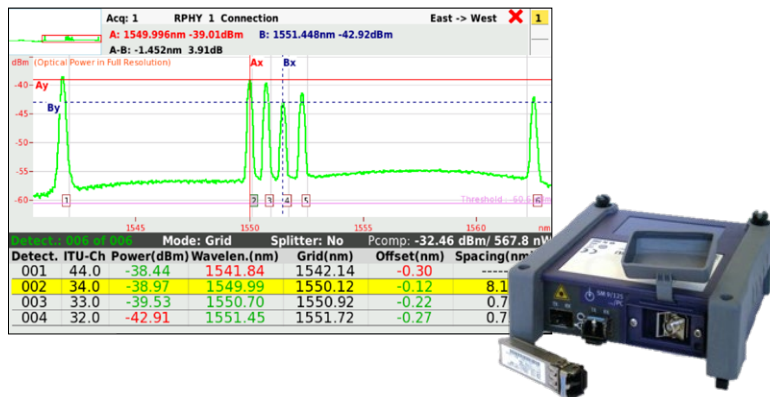

OCC-4056C DWDM Optical Channel Checker Module

Optical power measurement if splitting a PON network from DAA Node

As part of PON network activation technicians must validate that downstream and upstream optical power levels are within expected ranges prior to final connection of end devices. For G-PON, EPON, and XGS-PON or NG-PON2 the [OLP-87 PON power meter](#) can perform wavelength selective power level measurement. It also supports through mode operation and upstream burst mode measurement enabling both upstream and downstream power level measurements. It also helps in validating the ONT/ONU device by checking if the device is active and responding to the PON network equipment (OLT (Optical Line Terminal)).



OLP-87 G & XGS-PON or NG-PON2 Selective PON power meter

DAA Installation and Cutover Workflow

As its name implies, this section is split between testing required during the actual DAA node installation and testing required during the configuration and cutover.

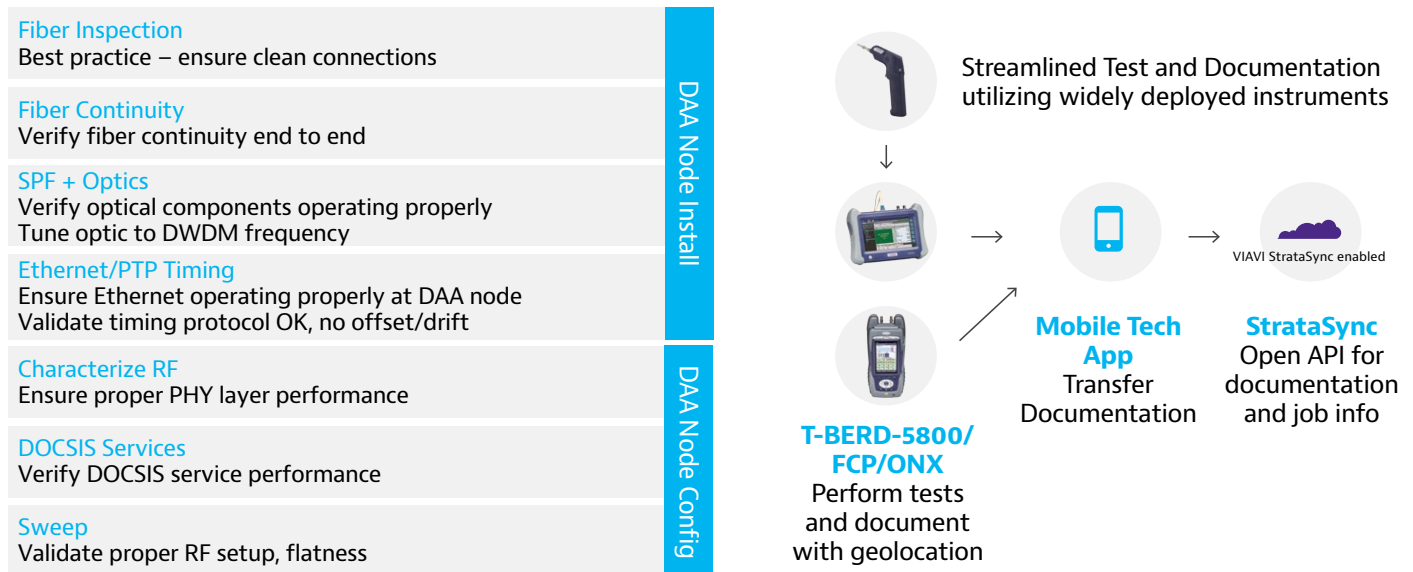

DAA Installation and Cutover Considerations

DAA Node Installation testing begins with fiber inspection and cleaning (if necessary) and end to end continuity check – nothing else matters if signal is not present on the fiber. It is worth adding a reminder here that not all test gear is capable of testing through DWDM muxes, keep this in mind when selecting appropriate instruments for this test need.

Next steps include verifying that the optical components including the SFP are working properly. If tunable SFP's are being used they must be tuned to correct wavelength at this point. Tunable SFP's are gaining in popularity despite their higher cost/unit vs fixed wavelength units. The ability to stock just one SKU in each truck capable of covering all wavelengths vs 16 or more different SKU's makes them an attractive option for an increasing number of operators.

Basic steps for SFP Tuning and Verification

- Tune optic to appropriate frequency (if tunable) – VIAVI OCC 4056 or TB-5800
- Verify SFP is operating on correct frequency, not drifting, appropriate power – VIAVI OCC 4056
- Ensure no BER – VIAVI T-BERD 5800
- Repeat tests included in HE/Hub Construction

Once the optics are up and running it is important to run Ethernet validation tests including PTP timing tests. Ethernet connectivity to CCAP and end to end throughput testing ensures the performance and stability of the Ethernet link feeding the node.

Newer industry standard for single and multiple service Ethernet and IP service activation test.

Measure Key Performance Indicators and Bandwidth Profile.

- CIR, EIR (Throughput)
- Frame Delay – FD (Latency)
- Frame Delay Variation – FDV (Jitter)
- Frame Loss Rate – FLR
- Committed Burst Size – CBS
- Policing
- Fully automated with report generation



For DAA Node Config and Cutover, the focus is on ensuring that the services provided by the node are operating properly. Standard DOCSIS service testing at the node output validates that specified services levels can be met, and RF testing including sweep ensure that the RF setup/alignment is solid and won't be the cause of intermittent problems later. It is recommended to repeat the DOCSIS, Video, and Voice tests recommended in the Headend Hub Construction Verification section above

DAA Maintenance and Troubleshooting Workflow

Once the entire DAA value stream is operational and nodes are cut over, they will still need to be monitored and maintained. While many operators will drive fiber deeper into their plant via DAA deployment, most of the drivers of plant maintenance remain as very few operators are pushing to N+0 with cascade depths typically remaining at N+3 or higher. In a DAA plant squirrels will still feast on cables, cars will still run into poles, and most importantly homes/drops will continue to drive ingress remediation truck rolls. The need for plant maintenance does not change, but how it is performed must change as DAA transforms networks.

- Leakage**
Efficiently find/fix plant integrity issues
- Ingress Suppression**
Continue to address the "85% problem"
- PTP Wander**
Ensure timing issues don't cause BER
- PTP Wander**
Verify correct channels present and in-spec
- Fiber Assurance**
Find breaks faster proactively address bends
- HFC Assurance**
Detect and localize QoE-impacting plant issues
- Ethernet Assurance**
Validate end to end performance to detect issues before customers complain

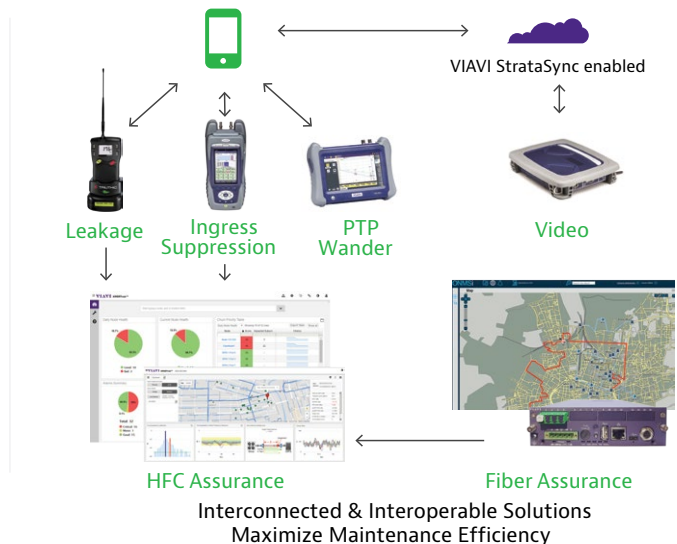

DAA Maintenance & Troubleshooting Considerations

It is well understood by now that all DAA variants eliminate RF test points from hubs, disallowing the use of traditional rack-mounted return path monitoring, forward/return sweep, and leakage taggers. With ingress remediation commanding 85+% of maintenance tech time, it is critical that operators retain essential capabilities like return path monitoring and leakage to address it. Return sweep is also still considered mandatory by operators globally for amp alignment, critical troubleshooting use, and as a companion to PNM tools. Fortunately, a solution has been developed in cooperation between the leading test vendor and all major DAA infrastructure vendors that enables reuse of existing field meters and technician workflows for return sweep, and upstream ingress monitoring and remediation. Based on CableLabs standards, this solution is applicable to networks deploying DAA systems from any vendor with CableLabs compliant NDF/NDR implementations. Use of DAA nodes to transmit leakage tags was an early request from operators to DAA vendors and is also now generally available.

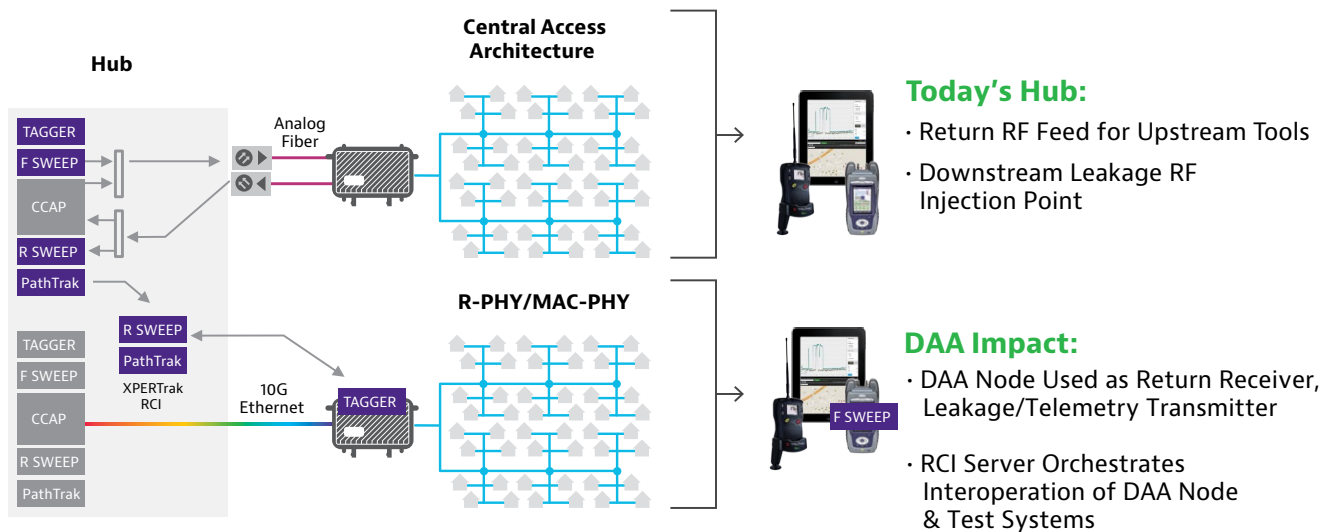

Result: Seamless Transition Legacy → DAA For Sweep

Virtualization Enables Test Capability Continuity

Leakage: Proactive driveout leakage management processes are still recommended post-DAA implementation. Thresholds will vary and should be reduced as the network is tightened up over time, targeting all leaks over 20uV/m for remediation should be achievable by most systems. Ideally four frequencies will be monitored across the downstream spectrum band to ensure complete coverage and not miss frequency-specific shielding weaknesses. Wide OFDM downstream carriers can create blind spots for systems relying exclusively on signal tags, it is recommended that OFDM detection be used in these regions to enable full coverage.

Ingress suppression: Even as fiber pushes deeper into networks, ingress suppression remains the single largest consumer of maintenance tech time. A robust leakage management program will reduce the frequency of ingress runs, but when they are required high performance spectrum analysis in the hands of maintenance tech's is still absolutely critical for efficient find and fix processes. The wide OFDM-A upstream carriers introduced by DOCSIS 3.1 create challenges for traditional spectrum analyzers, it is recommended to pursue a maintenance solution enabling variable persistence heatmap analysis from the RPD to address these challenges.

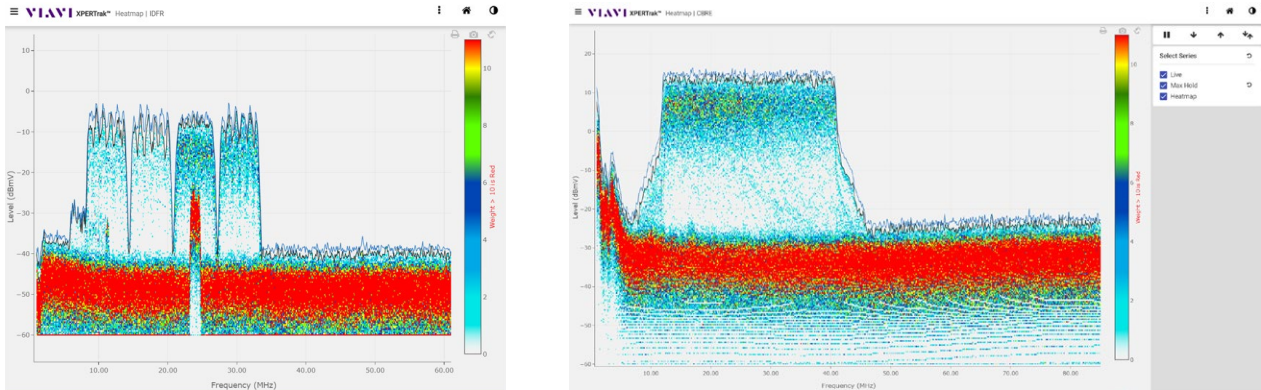

Beyond the field activities listed above, assurance systems are still critical to ensure that operators can:

- Quickly be alerted to issues impacting subscriber QoE
- Trend network performance to spot emerging issues before they become customer impacting
- Maximize maintenance ROI by focusing work on issues that matter most

While historically Assurance solutions have been somewhat siloed between Fiber, Ethernet, and HFC systems. As the lines between these technologies/mediums blur (think 10G optical Ethernet link going to DAA nodes for example) Assurance solutions are undergoing a similar convergence. Fiber monitoring data is now being overlaid on HFC Assurance system maps, and automation of service-level testing is leveraging test probes from all three technology areas.

HFC Assurance

Once the DAA network is operational, the role of HFC assurance systems is to continue to provide all the same visibility that Tech Ops and NOC folks had before the DAA transition, plus more. Upstream monitoring data previously provide by hub-based measurement hardware must now come from virtual sources such as the RPD or CCAP. Test vendors must walk a tightrope to ensure that this data can be collected at a rate necessary to provide meaningful insight and on-demand troubleshooting capabilities while not impacting service provision capabilities of these devices. The secret sauce in these systems lies more in data collection and analysis than in the data itself.

Monitoring considerations:

- Monitor network performance from the subscriber level up – ensure pockets of heavily impacted subscribers don't get lost in node-level averaging.
- Monitor both physical layer and service layer data. PHY data can be a critical early indicator of impending service issues and is helpful in determining/locating root cause issues
- Use all your data sources. Combining PNM, QoE, plant leakage data, and past field meter measurement data on a single map can illuminate issues and speed their resolution

DAA Deployment Project and Data Management

By now you should have a good understanding of the types of tests that need to be considered at each stage of a DAA deployment lifecycle, why they are needed, and some of the challenges presented at each stage. The bigger challenge comes in when the overall lifecycle is viewed in its entirety from a program management standpoint including the interdependencies between stages. There are many different workgroups involved including both direct and contractors, a wide variety of test equipment, and a ton of test data to be collected, analyzed, and stored. Knowing when all prerequisite tests have been completed and passed before proceeding with the next step in the process is tedious, time-consuming, and error-prone unless the process is centralized and automated. Creation of a birth certificate upon DAA node cutover including all test data relevant to its performance can be invaluable when trending performance over time and troubleshooting issues but is not feasible using manual methods. For these reasons and others it is recommended that a cloud-based workflow management system be used to ensure correct tests are being deployed to test gear per task, data is being centrally collected and analyzed including from contractors, and is made available on-demand via dashboards or for export via API. Below is an example deployment of a cloud-based workflow system and how it is used across the DAA lifecycle.

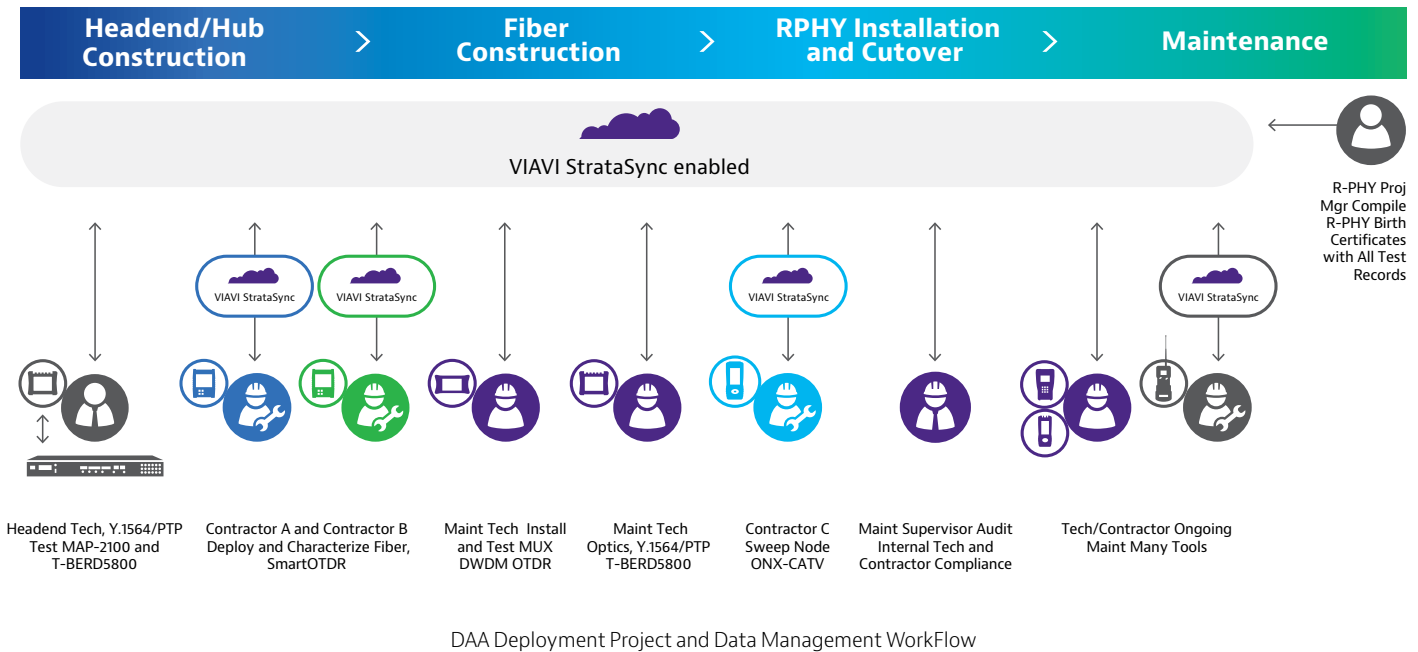

Conclusion

There is no doubt that DAA is a key element that will allow HFC networks to remain the most cost-effective medium for delivering data, voice, and video services well into the future. Many early adopters are well into their deployments, proving that it can be done but not without some challenges along the way. Hopefully the overall DAA deployment framework and test details provided in this document will help you to plan for your own transition and achieve a more problem-free experience.

Solution Guide

Solution	Description	DAA Test Activities
VIAVI FiberChek Probe	Handheld device for fiber inspection and analysis	Fiber inspection
VIAVI FiberChek Sidewinder	"All-in-one" handheld inspection and analysis solution for multifiber connectors such as MPO	Fiber inspection (multifiber)
VIAVI SmartOTDR	Single device with optical time domain reflectometry measurement, fiber end face analysis, optical loss testing and visual fault locator	OTDR test
VIAVI FiberComplete	Automatic bi-directional insertion loss (IL), bi-directional optical return loss (ORL using OCWR method), distance and bi-directional OTDR or fault finder	Bi-directional testing to improve fiber link characterization
VIAVI T-BERD 2000/4000	Test platform for OTDR and OCC modules	OTDR and channel check testing
VIAVI COSA-4055 (CWDM) and OCC-4056C (DWDM)	CWDM optical spectrum analyzer/DWDM optical channel checker	Channel checking for presence and power. Measure actual wavelength, offset and drift, and channel spacing. SFP tuning for OCC-4056C
VIAVI OLP-87 PON power meter	FTTx/PON power meter for use in activating and troubleshooting B-PON, E-PON and G-PON and next generation high speed XGS-PON and NG-PON2	Optic power measurement during network activation
VIAVI OTU-5000/SmartOTU	Small form-factor remote fiber monitoring unit, integrated with XPERTrak HFC Assurance System	<ul style="list-style-type: none"> • Monitor fiber links between hub and parent R-PHY node • Notification of fiber break or fiber stress issues
VIAVI T-BERD/MTS-5800 (100G)	Handheld dual-port 100G instrument for testing, service activation, troubleshooting, and maintenance	<ul style="list-style-type: none"> • GPS test • PTP test (PTP timing error test) • Ethernet test (backhaul)
VIAVI ONX-CATV	Handheld HFC/DOCSIS meter...	<ul style="list-style-type: none"> • RF characterization and conformance test • DOCSIS service-level testing • Sweep test • Live field spectrum analysis
VIAVI XPERTrak	DAA-ready Assurance solution enabling continuity of critical test capabilities during and after DAA transition plus identification if the most critical network issues to address first.	<ul style="list-style-type: none"> • HFC service assurance • PNM analysis • RPD support for sweep and live spectrum • Integrated fiber alarming and remote on-demand OTDR test
VIAVI Seeker X	DAA-ready plant leakage solution useful to find network integrity issues	<ul style="list-style-type: none"> • Validate tight plant after construction/repair • Proactively find shielding weaknesses reducing ingress opportunities

VIAVI VSE-1100	High-performance integrated field spectrum and video analyzer. Features Spectrum, QAM, and MPEG video analysis for headend/hub sites ruggedized for outside plant use	<ul style="list-style-type: none"> · Verify presence/absence/quality of all video carriers · Validate channels/streams on each carrier?
VIAVI StrataSync	Cloud-enabled platform for asset management, configuration management, and test-data management of VIAVI instruments as well as asset tracking of non-VIAVI instruments	Management of vendors, employees and subcontractors as one team during all DAA network deployment activities



Contact Us **+1 844 GO VIAVI**
(+1 844 468 4284)

To reach the VIAVI office nearest you,
visit [viavisolutions.com/contact](https://www.viavisolutions.com/contact)

© 2020 VIAVI Solutions Inc.
Product specifications and descriptions in this document are subject to change without notice.
testguide-daa-wp-xpf-nse-ae
30191039 900 0220