



FCOMP/-PRO Option
For T-BERD[®]/MTS-2000V2, -4000 V2
and OneAdvisor-800 Platforms

User Manual

FCOMP/-PRO Option

For T-BERD®/MTS-2000V2, -4000 V2

and OneAdvisor-800 Platforms

User Manual



Viavi Solutions
1-844-GO-VIAVI
www.viavisolutions.com

Notice

Every effort was made to ensure that the information in this document was accurate at the time of printing. However, information is subject to change without notice, and VIAVI reserves the right to provide an addendum to this document with information not available at the time that this document was created.

Copyright

© Copyright 2024 VIAVI, LLC. All rights reserved. VIAVI, Enabling Broadband and Optical Innovation, and its logo are trademarks of VIAVI, LLC. All other trademarks and registered trademarks are the property of their respective owners. No part of this guide may be reproduced or transmitted electronically or otherwise without written permission of the publisher.

Trademarks

VIAVI, MTS/T-BERD 4000 V2, MTS/T-BERD 2000, MTS/T-BERD 5800, SmartOTDR, CellAdvisor 5G and OneAdvisor 800 are trademarks or registered trademarks of VIAVI in the United States and/or other countries.

Microsoft, Windows, Windows CE, Windows NT, and Microsoft Internet Explorer are either trademarks or registered trademarks of Microsoft Corporation in the United States and/or other countries.

Netscape Navigator is a trademark or registered trademark of Netscape Communications Corporation in the United States and other countries.

Ordering information

This guide is a product of VIAVI's Technical Information Development Department, issued as part of the User Manual.

Product Regulatory Compliance

California Proposition 65

California Proposition 65, officially known as the Safe Drinking Water and Toxic Enforcement Act of 1986, was enacted in November 1986 with the aim of protecting individuals in the state of California and the state's drinking water and environment from excessive exposure to chemicals known to the state to cause cancer, birth defects or other reproductive harm.

For the VIAVI position statement on the use of Proposition 65 chemicals in VIAVI products, see the Hazardous Substance Control section of [VIAVI's Standards and Policies](#) web page.

EU WEEE and Battery Directives

This product, and the batteries used to power the product, should not be disposed of as unsorted municipal waste and should be collected separately and disposed of according to your national regulations.

VIAVI has established a take-back processes in compliance with the EU Waste Electrical and Electronic Equipment (WEEE) Directive, 2012/19/EU, and the EU Battery Directive, 2006/66/EC.

Instructions for returning waste equipment and batteries to JDSU can be found in the WEEE section of [VIAVI's Standards and Policies](#) web page.

If you have questions concerning disposal of your equipment or batteries, contact VIAVI's WEEE Program Management team at WEEE.EMEA@VIAVISolutions.com.

EU REACH

Article 33 of EU REACH regulation (EC) No 1907/2006 requires article suppliers to provide information if a listed Substances of Very High Concern (SVHC) is present in an article above a certain threshold.

For information on the presence of REACH SVHCs in VIAVI products, see the Hazardous Substance Control section of VIAVI's Standards and Policies web page.

EU CE Marking Directives (LV, EMC, RoHS, RE)

This product conforms with all applicable CE marking directives. Please see EU Declaration of Conformity for details.



Contents

About This Guide	xii
Purpose and scope	xii
Assumptions	xii
Technical assistance	xii
Recycling Information	xii
Conventions	xii
Chapter 1 FCOMP/-PRO Principles	1
General introduction	2
FCOMP/-PRO Tests description	3
Loss test and Loss test + OTDR	3
Requirements	3
Configurations	4
Automatic configuration in Loss Test (+ OTDR) mode	7
Real time bi-directional OTDR analysis: Loopback Method	8
Requirements	8
Measurement process	8
Real time bi-directional OTDR analysis: TrueBIDIR method	9
Requirements	9
Measurement process	10
Report (.pdf)	12
High Fiber Count	14

Chapter 2	Establishing references for Loss & ORL measurements, without Switch	17
Activating the function		18
Establishing References		18
Factory References		19
Reference process (Loopback and Side by Side)		20
Loopback Referencing method.		21
Side-by-Side referencing method		22
Chapter 3	Loss test (bi-directional IL/ORL + Fault Finder)	25
Configuring the Loss test.		26
Test Cables parameters		27
IL/ORL parameters		28
IL / ORL Alarms parameters		29
Link parameters.		30
Report parameters		31
FCOMP-PRO Configuration file		33
Saving the parameters from FiberComplete configuration.		34
Loading a configuration file FiberComplete.		35
Performing the tests		35
Sending a message.		36
Starting the test		37
Results screen		38
Cable view		38
IL/ORL BiDir View		39
Fault Finder		41
Manual saving and report generation		41
Chapter 4	Loss test and OTDR (unidir or manual bidir)	45
Configuring the OTDR test (unidir and/or manual bidir - no TrueBIDIR or Loopback)		46
OTDR parameters		46
OTDR Alarms parameters		47
Report parameters		49

Starting the test	49
OTDR Results screen	50
Manual otdr saving and report generation	51
Saving traces and creating a report	51
Opening a report	53
Chapter 5 Loopback OTDR	55
Configuring the Loopback Test	56
Test Cables parameters	56
OTDR parameters	58
Alarm parameters	58
OTDR Alarms parameters	59
Link Description parameters	60
Saving configuration	61
Loading a configuration file	62
Performing the tests	63
Results screen	64
Results page	64
Process View	64
Summary view	64
SmartLink view	65
OTDR results trace / SmartLink results	66
Saving results and generating a report	67
Saving results and creating a report from results page	67
Opening a report	68
Chapter 6 TrueBIDIR OTDR	71
Configuring the True Bidirectional Test	72
Test Cables parameters	72
OTDR parameters	73
Alarms OTDR parameters	74
Performing the tests	76
Results screen	76
Results page	76
Bi-Directional SmartLink	76
OTDR traces	77



About This Guide

The VIAVI equipments provide handheld, modular platforms designed for the construction, validation and maintenance of fiber networks.

The topics discussed in this chapter are as follows:

- [“Purpose and scope” on page xii](#)
- [“Assumptions” on page xii](#)
- [“Technical assistance” on page xii](#)
- [“Recycling Information” on page xii](#)
- [“Conventions” on page xii](#)

Purpose and scope

The purpose of this guide is to help you successfully use the equipment features and capabilities. This guide includes task-based instructions that describe how to configure, use, and troubleshoot the equipment with OTDR/Fibercomplete module and FCOMP/-PRO software option.

Assumptions

We are assuming that you have basic computer and mouse/track ball experience and are familiar with basic telecommunication and fiber optic concepts and terminology.

Technical assistance

If you require technical assistance, call 1-844-GO-VIAVI. For the latest TAC information, go to <http://www.viavisolutions.com/en/services-and-support/support/technical-assistance>.

Recycling Information

VIAVI recommends that customers dispose of their instruments and peripherals in an environmentally sound manner. Potential methods include reuse of parts or whole products and recycling of products components, and/or materials.

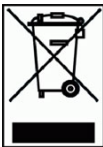

Waste Electrical and electronic Equipment (WEEE) Directive

In the European Union, this label indicates that this product should not be disposed of with household waste. It should be deposited at an appropriate facility to enable recovery and recycling.

Conventions

This guide uses naming conventions and symbols, as described in the following tables.

Table 1 Typographical conventions

Description	Example
User interface actions appear in this typeface .	On the Status bar, click Start .
Buttons or switches that you press on a unit appear in this TYPEFACE .	Press the ON switch
Code and output messages appear in this <code>typeface</code> .	All results okay
Text you must type exactly as shown appears in this <code>typeface</code> .	Type: a:\set.exe in the dialog box
Variables appear in this <i>typeface</i> .	Type the new <i>hostname</i> .
Book references appear in this <i>typeface</i> .	Refer to <i>Newton's Telecom Dictionary</i>
A vertical bar means "or": only one option can appear in a single command.	platform [a b e]
Square brackets [] indicate an optional argument.	login [platform name]
Slanted brackets < > group required arguments.	<password>

Table 2 Keyboard and menu conventions

Description	Example
A plus sign + indicates simultaneous keystrokes.	Press Ctrl+s
A comma indicates consecutive key strokes.	Press Alt+f,s
A slanted bracket indicates choosing a submenu from menu.	On the menu bar, click Start > Program Files .

Table 3 Symbol conventions



This symbol represents a general hazard.



This symbol represents a risk of electrical shock.



NOTE

This symbol represents a Note indicating related information or tip.

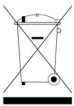

This symbol, located on the equipment or its packaging indicates that the equipment must not be disposed of in a land-fill site or as municipal waste, and should be disposed of according to your national regulations.

Table 4 Safety definitions



WARNING

Indicates a potentially hazardous situation which, if not avoided, could result in death or serious injury.



CAUTION

Indicates a potentially hazardous situation which, if not avoided, may result in minor or moderate injury.

FCOMP/-PRO Principles

This chapter describes the features and usage of the FiberComplete PRO (FCOMP-PRO) - The fiber acceptance testing process control application.

The topics discussed in this chapter are as follows:

- ["General introduction" page 2](#)
- ["FCOMP/-PRO Tests description" page 3](#)

General introduction

FiberCompletePRO™ is the first solution to fully automate all the fundamental fiber-qualification tests, such as bidirectional insertion loss (IL), optical return loss (ORL) and optical time domain reflectometry (OTDR), with one module from one optical port. For high fiber count projects, it is now possible to automatically test up to 12 ribbon fibers with the Multi-fiber MPO optical switch module.

Select the best module and software configuration upon the fiber qualification tests needed:

- **Bi-Directional insertion loss (IL) and ORL with Fault Finder:**
 - available with E41xx-FCOMPFF and E41xx-B-FCOMP modules
 - available with E41xx-B modules implemented with E41OTDRPM optical power meter option and EOTDR-TO-FCOMP-UPG software option.
- **Bi-Directional insertion loss (IL), ORL and OTDR** (unidirectional and/or bi-directional):
 - available with E41xx-B FCOMP modules
 - available with E41xx-B modules implemented with E41OTDRPM optical power meter option and EOTDR-TO-FCOMP-UPG software option.
- **On-board true bi-directional OTDR event analysis**
 - TrueBIDIR Method (two units at each end of the link)
 - available with E41xx-A, E41xx-B, E41xx-C, E41xx-B FCOMP modules with ETRUEBIDIR-FCOMP-PRO software option
 - Loopback Method (a single unit at one end and a loop cable at the other end)
 - available with Smart OTDR A & B, E41xx-A, E41xx-B, E41xx-C, E41xx-B FCOMP modules with ELOOPBACK-FCOMP-PRO software option
- **High Fiber Count**
 - available with an additional module: E41MPO12SM multi-fiber MPO switch module.



NOTE

VIAVI recommends to perform FiberComplete / FiberComplete-PRO measurements with test platforms from the same range.

FCOMP/-PRO Tests description

Loss test and Loss test + OTDR

Requirements

FCOMP/-PRO-Loss Test and Loss Test + OTDR are used to perform automatically and through a single connection port, the following tests:

- Bidirectional insertion loss (IL)
- Bidirectional optical return loss (ORL) using the continuous wave mode (OCWR)
- Distance/length measurements
- Unidirectional / manual Bidirectional OTDR (when TrueBIDIR or Loopback Software options are not installed) and/or fault analysis, according to the module/option installed.

To carry out the measurements, 2 equipments are needed, both equipped with Fiber-Complete capable modules and broadband power meters on the mainframes.

Using one unit at each end of the fiber under test and without any connection/disconnection, IL/ORL and distance measurements are performed and results exchanged via the fiber under test (FUT).

If the OTDR is selected, an OTDR measurement is launched automatically:

- **Unidirectional mode:** the OTDR acquisition is performed from the local unit where the test has been initiated. Traces are saved locally
- **Bidirectional mode:** the OTDR acquisition is initiated successively from each unit. The traces are saved locally. (See "[TrueBIDIR OTDR](#)" on page 71 for automated and real-time bi-directional OTDR analysis)

If the **Fault Finder** is set to **Yes** (note: it automatically sets the **OTDR** to **No**), a failed value of IL and/or ORL triggers the fault finder function automatically in order to identify the worst faulty elements.

Figure 1 Configuration for IL/ORL + OTDR/Fault Finder function

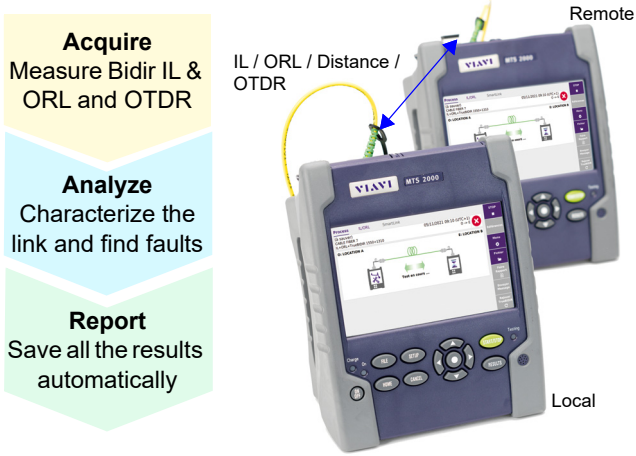

Configurations

Two configurations are available, depending on the tests that have to be performed:

- Construction/Installation tests with loss, optical return loss, distance and OTDR.
- Acceptance Tests with loss, optical return loss and distance, and faults detection in case of problem.

Construction/Installation Test

In this configuration, bidirectional IL and ORL, length and/or unidirectional/bidirectional OTDR measurements are performed.

The bidirectional IL/ORL and length results are stored on each unit with SW version <23.5x only.

For SW version $\geq 23.5x$: only the local unit (the one that initiates START) stores all results files.

The OTDR traces are stored on the locally unit (where the test has been initiated).

Figure 2 Construction/Installation Test

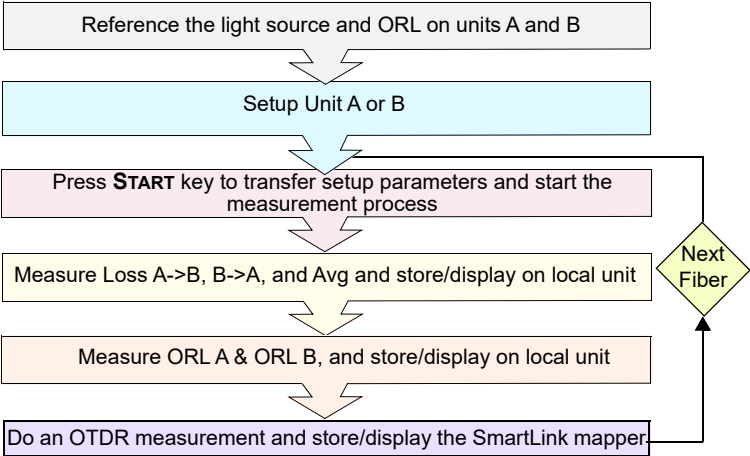

If a Bidirectional OTDR measurement is performed, the OTDR results are automatically saved on each unit;

- The OTDR results trace for acquisition performed from Location A to Location B is stored on the local unit (Location A)
- The OTDR results trace for acquisition performed from Location B to Location A is stored on the remote unit (Location B)

If TrueBIDIR, all the OTDR measurements are stored on the local unit

Acceptance Tests

In this configuration, the bidirectional IL, ORL and length measurements are performed and results are automatically stored on local unit.

If the **Fault Finder** function has been selected in the **Setup** menu, and if at least one result exceeds the defined IL/ORL thresholds (Splice > 0.3 dB, Connector > 0.75 dB, Reflectance > -32 dB and Bend > 1 dB), the predominant defects by event type causing the failure are identified and located.

The FiberComplete screen displays an easy to interpret result table that prompts predominant issues for easy troubleshooting.

Figure 3 FCOMP Pro view



Figure 4 Acceptance Test

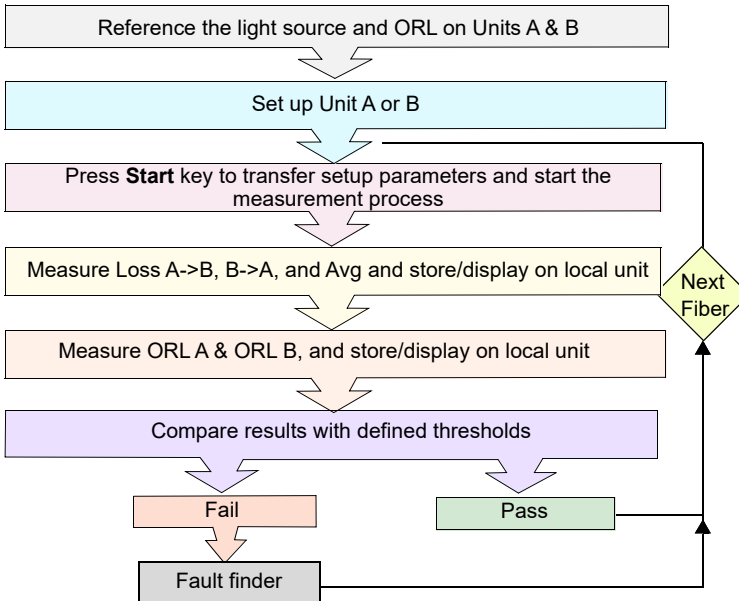

Automatic configuration in Loss Test (+ OTDR) mode

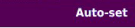
Press the key  to configure automatically the acquisition parameters as follows:

- Test Cables
 - Launch/Receive Cable: **No**
 - Unit: **meter**
 - Table View: **Fiber**
- IL/ORL
 - IL/ORL Measurement: **IL/ORL Bidir.**
 - Lasers: **1310/1550**
 - Length measurement: **No**
 - Fault Finder: **No**
- IL/OLR Alarms: **Default**
- OTDR
 - Measurement: **Unidir**
 - OTDR Acquisition: **Auto**
 - Smart SLM: **No**
 - Laser: **1310/1550 nm**

Parameters specific if OTDR measurement is defined: see "[Loss test and OTDR \(unidir or manual bidir\)](#)" page 45.

- OTDR Alarms
 - Alarm Level: **Fail**
 - Threshold: **Default**
- Link
 - Change Fiber Nbr: **Increment**
 - Direction: **A -> B**
 - Extremities are different: **No**
- Report
 - File save in: **disk/[Function]**
 - Filenaming: **[Fiber_Id][Fiber_Num]**
 - File Content: **All Traces**

Parameter specific if OTDR measurement is defined: see "[Loss test and OTDR \(unidir or manual bidir\)](#)" page 45.

 - Auto Store: **Yes**
 - Report As: **pdf**
 - Report Layout: **Standard**

Real time bi-directional OTDR analysis: Loopback Method

This test is used to perform a bi-directional OTDR process and analysis on 2 fibers, at the same time, using a single test device

Requirements

To perform a loopback measurement, you need:

- Launch cable/cord
- Loopback cable/cord
- Receive cable/cord
- To get the right match of events, it is important to validate the link continuity/route of the two fibers by using a VFL or the real-time OTDR mode

Measurement process

To perform the measurement, follow the wizard that guides the user through the different steps of operation. A technician at location A, connects the launch & receive cable/cord to the two fibers to be tested. A second technician at location B, connects the loopback cable/cord that will "loop" the two fibers together.

- 1 Once the installation and configuration are performed, press **START** and follow the popup indications
- 2 Once completed, disconnect the launch cord from the device. Then, connect the receive cord, which will then become the launch cord.
- 3 Press **START** to launch the test on the other direction.
- 4 At the end of the process, the results (average loss values coming from both directions, both ends) are displayed in the SmartLink tab. A switch button allows to view 1st fiber or 2nd fiber bi-directional OTDR results.

Figure 5 Loopback bi-directional measurement process

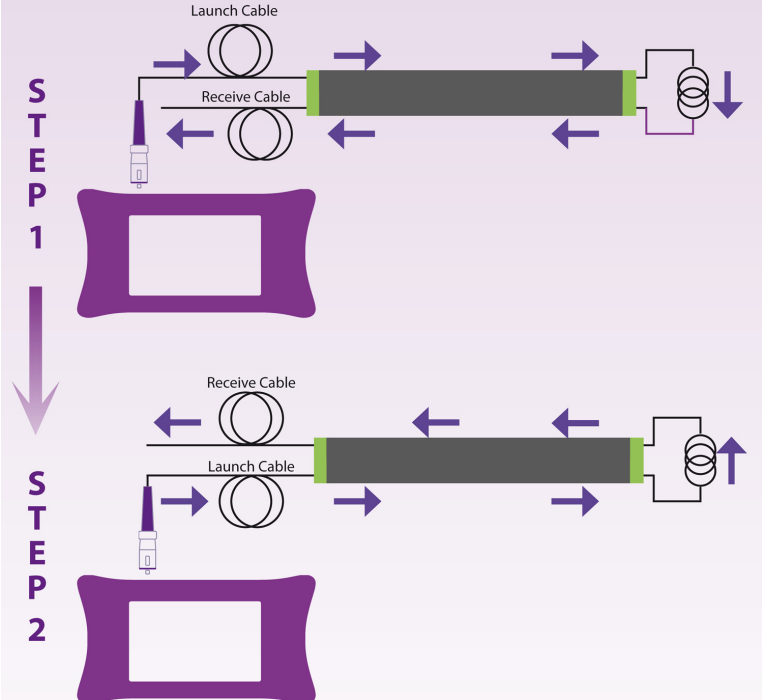

Real time bi-directional OTDR analysis: TrueBIDIR method

This test is used to perform a bi-directional OTDR process and analysis on 1 fiber, using two devices at each end of the link.

Requirements

To perform a TrueBIDIR measurement, you would need:

- Launch cable/cord
- Receive cable/cord



NOTE

The moment the instruments are connected to the Fiber Under Test (FUT) an instant continuity check automatically pairs the units and performs length measurement.

Measurement process

Figure 6 TrueBidir measurement process

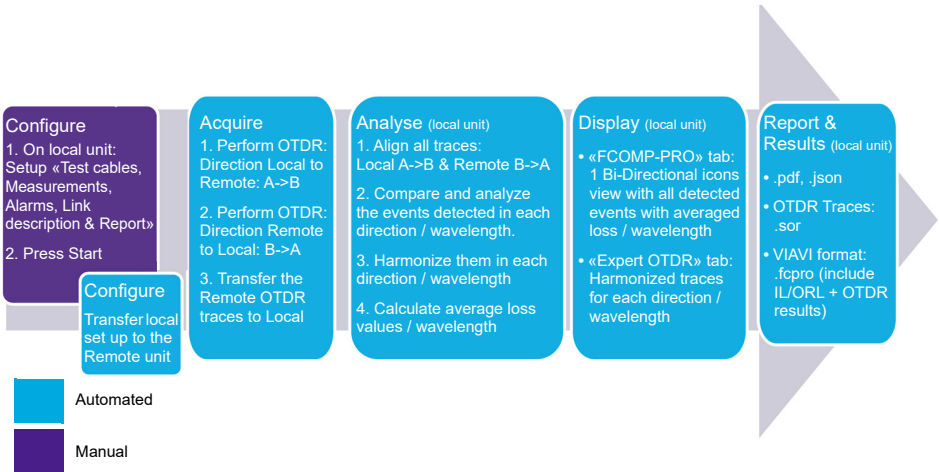

A technician at location A, connects the launch cable/cord to the fiber to be tested. A second technician at location B, connects the receive cable/cord. As soon as it connects a beep is emitted and a green line is displayed on the Process schematic.

- Once the installation and configuration are finished, press START and let the device perform the measurement sequence.
- A testing arrow flashes until the end of the measurement process. At the end of the complete sequence, a beep is also emitted.
- The bi-directional OTDR results (average loss values coming from both directions, both ends) are displayed in the SmartLink tab.

Figure 7 TrueBIDIR measurement process

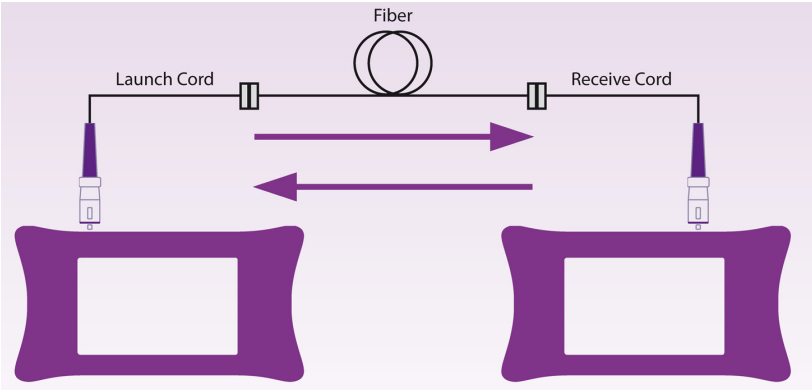

Report (.pdf)

The pdf report generated from FCOMP/-PRO results contains different features.

- The first page always features all set up information, as well as the Link Insertion Loss, ORL and length results.

Figure 8 PDF report - Page 1

The screenshot shows a PDF report page with the following sections highlighted by numbered callouts:

- 1** Print Date : 06/12/2023 14:42 Fiber Optics : 23.68 TO_12306_12_2023_14_41_50001.fcpro.pdf
- 2** VIAMI Cable Id : 001 Location A : LOC A Job ID : Fiber Id/Number : TO_123 1 Location B : LOCB Technician Id : karine01
- 3** Date : 06/12/2023 14:41 (UTC+0) Mainframe's model : A : MTS 4000 V2 (S/N EBAH0376) B : MTS 4000 V2 (S/N EBAH08403) Module's model : 4138 FB65-FCOMP (S/N EMAW00124) 4138 FB65-FCOMP (S/N EMAW00474) Calibration Date : 25/05/2023 24/05/2023
- 4** Test Setup IL/ORL : 1550 nm OTDR : 1550 nm Alarms : A -> B
- 5** Threshold IL/ORL measurement USER 1 : Loss (dB) : >=1.0 ORL (dB) : <30.0 Threshold OTDR measurement USER : Connector Loss (dB) : >=0.20 Splice Loss (dB) : >=0.10 Reflectance (dB) : >=45 Slope(1310 SM) (dB/Km) : >=0.05 Slope(1550 SM) (dB/Km) : >=0.05
- 6** Reference Wavelength : 1550 nm Side/Side : -7.71 Loopback : --- ORL Power Lev. (dBm) : -6.50 ORL Zero (dB) : 57.29 1625 nm : -7.25 --- -6.50 57.75 1625 nm : -6.50 --- -6.50 58.50
- 7** IL/ORL & Length Results Mode: CW Length : 2413 m Wavelength : 1550 Loss B->A : 2.06 Loss A->B : 2.01 Avg Loss : 2.03 ORL A : 41.13 ORL B : 39.69

Section

- Report generation date, SW version, Filenaming
- VIAMI logo (can be customized), link description information from the device set up
- List of the devices used for the test
- Test set up per wavelength and direction (the report is generated from the device starting the test, the direction indicated is the one from this device)
- Thresholds for IL/ORL and OTDR measurement
- Reference values
- Features the link IL/ORL/Length results.
 The results come from:
 Mode = CW = Continuous Wave if IL/ORL Bidir. were performed.
 Mode = OTDR if only TrueBIDIR tests were performed (no IL/ORL Bidir. sequence).

- The second page features all events Loss and ORL as well as slope results.

Figure 9 PDF report - Page 2 OTDR Unidir.

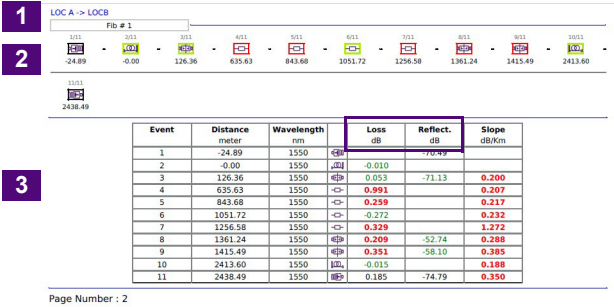

Section OTDR Unidir.

- Direction of the test
- Unidirectional icon SmartLink view
- Unidirectional Table featuring: each event location with Loss/Reflectance per wavelength; slope per fiber section

Figure 10 PDF report - Page 2 OTDR TrueBidir.

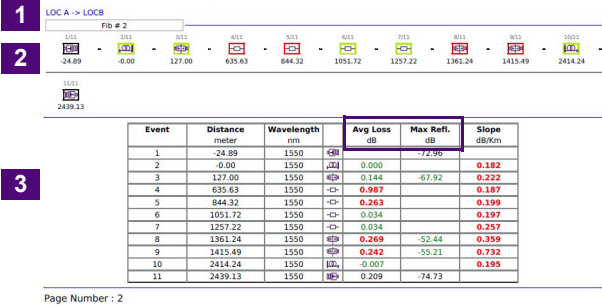

Section OTDR TrueBidir.

- Direction of the test
- Bi-directional icon SmartLink view
- Bi-directional Table featuring : each event location with Average Loss/ Max. Reflectance per wavelength ; average slope per fiber section

- The next pages feature each unidirectional OTDR detailed test results for each wavelength and each direction.

Figure 11 PDF report - Page 3, 4...

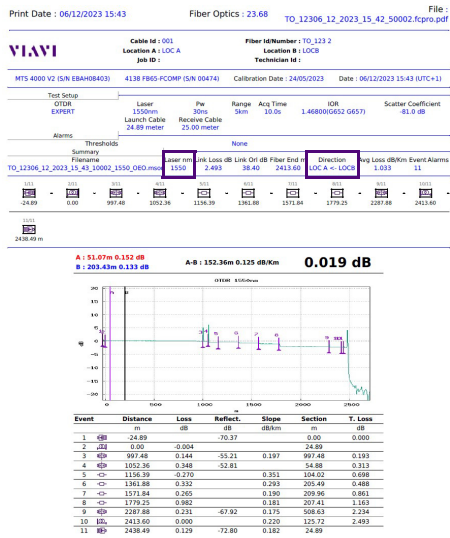
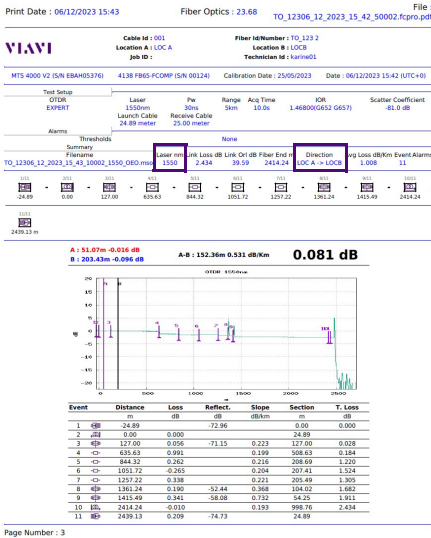

High Fiber Count

High Fiber count allows you to scale all the bi-directional test capabilities and automate the test sequencing of high-density fiber cables. Multiple fibers can be certified with a one button press and a single test sequence.

By adding a MPO switch module, a bulk of 12 fibers or a ribbon cable can be tested in a single sequence, including an automatic fiber continuity test and mapping to establish MPO polarity and type (A, B, C).

Via the **Manage Project** softkey , configure and create the Cable view that will help you automate and sequence multiple fibers tests plus track the progress and status of the fibers, labels and ribbons to test and/or to be tested.

Figure 12 Testing simplex fiber connector network (scenario 1)

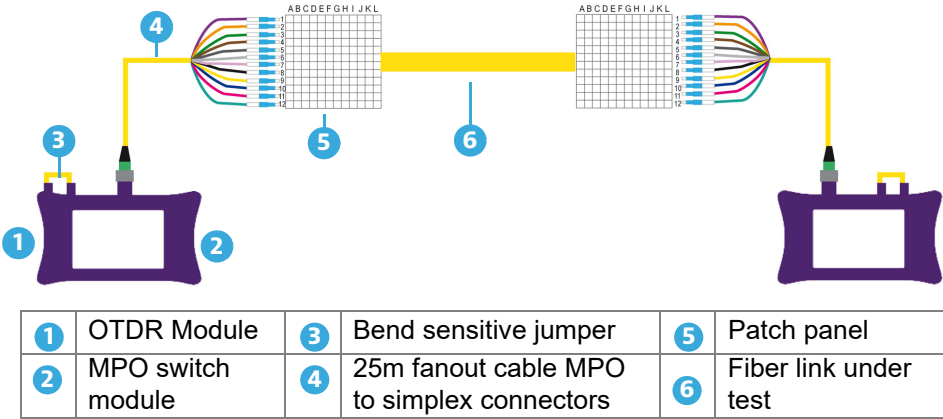
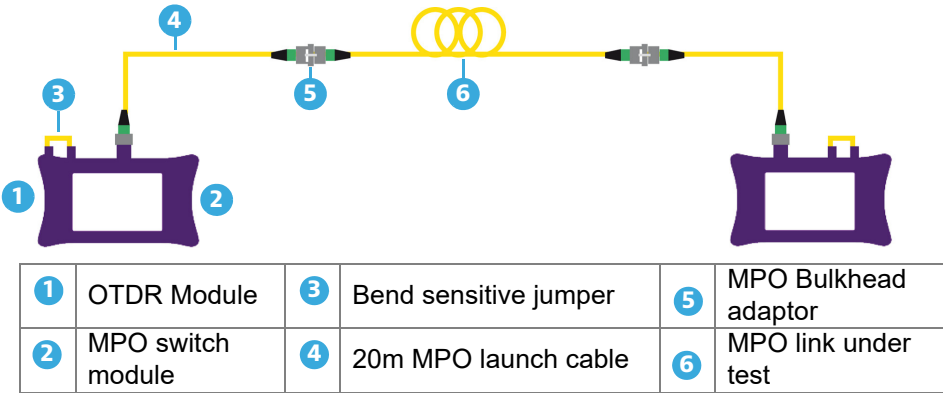

Figure 13 Testing native MPO Network (scenario 2)



Establishing references for Loss & ORL measurements, without Switch

This chapter describes the activation of FCOMP/FCOMP-PRO function and the process to perform the Loss and ORL references using a two-cord reference method or a loop-back reference method.

Refer to [Chapter 7](#) for Loss and ORL referencing with the MPO switch module.

The topics discussed in this chapter are as follows:

- ["Activating the function" page 18](#)
- ["Establishing References" page 18](#)

Activating the function

- 1 Press the HOME button.
- 2 Select the icon FiberComplete (FCOMP) or FiberComplete PRO (FCOMP-PRO)



Establishing References

To get a meaningful measurement, the light sources and the two launch/test cords used for the measurement have to be referenced (zeroed out). The references are valid for all fibers that will be tested during the day without disconnecting the test cords from the test port. If, at anytime, the test cords are disconnected from the test instruments and/or have been contaminated by dirt or dust, the test cords have to be re-inspected and referencing stage has to be redone.

Reference methods for insertion loss and ORL testing

Three Referencing methods are available.

- **Factory Ref.:** fastest process, higher loss uncertainties
- **Loopback Ref.:** more accurate than Factory Ref., less accurate than Side by Side
- **Side by side Ref.:** most accurate method, both test sets must be at the same location during the referencing process.

Table 5 Reference methods for Insertion Loss and ORL Testing

	Loopback Reference Method	Side-by-side Two -Cord Reference method
Setup requirement	No specific requirement	Units shall be at the same location for references
Description	Each unit is performing its own IL reference, with its module port source connected to the main-frame power-meter.	Each unit is performing its own IL reference, and units are connected using two test cords and a bulkhead adapter.

Table 5 Reference methods for Insertion Loss and ORL Testing

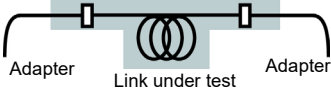
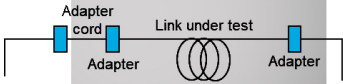
	Loopback Reference Method	Side-by-side Two -Cord Reference method
Recommendations	Easiest process. Not recommended for short links. Once the reference is performed, do not disconnect jumper from the test port	Most accurate reference method, but both units must be at the same location for the referencing process. Once the reference is performed, do not disconnect jumper from test ports
Loss principle	Loss measurement includes link connectors. 	Loss measurement includes one link connector. To include both connector add a reference grade adapter cord (as recommended in IEC standards). 

Factory References

Click on the  icon to fill the table with default reference values, measured at the factory.

As soon as the icon  is pressed and the table filled with default reference value, the display returns automatically to **Process** page.



NOTE

Factory references guaranty measurement uncertainty of +/- 1dB for IL and ORL, if all ports and connectors are cleaned and not damaged.

The following figure show the default values:

Figure 14 Factory References

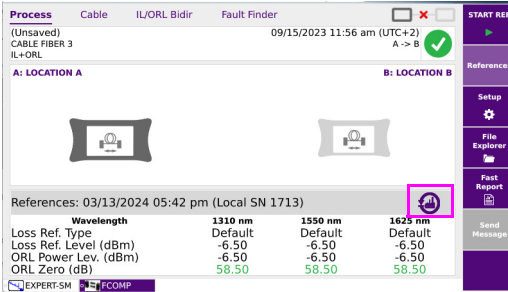

Reference process (Loopback and Side by Side)

The Power Meter option is mandatory onto the Mainframe.

Each test equipment must set its own references and follow this process:

- 1 From the results page, press **References > Start Ref** keys and follow the step by step instructions to perform references on each unit.

Figure 15 Choose between side by side or loopback for your loss referencing method

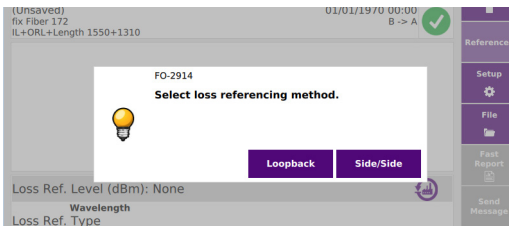

NOTE

Once the referencing method has been selected, the key **Skip** is available at each step. It enables to skip the step(s), and, if necessary, to return to process page.

Loopback Referencing method

The loopback referencing is used when the two units are at different location.

After clicking on **Loopback**, the wizard will guide you through two steps:

- 1 The Loss and ORL reference is used for loss and ORL testing. Connect the test cord from the module port to the mainframe powermeter and press **Ok** to start referencing.

Figure 16 Loss and ORL reference

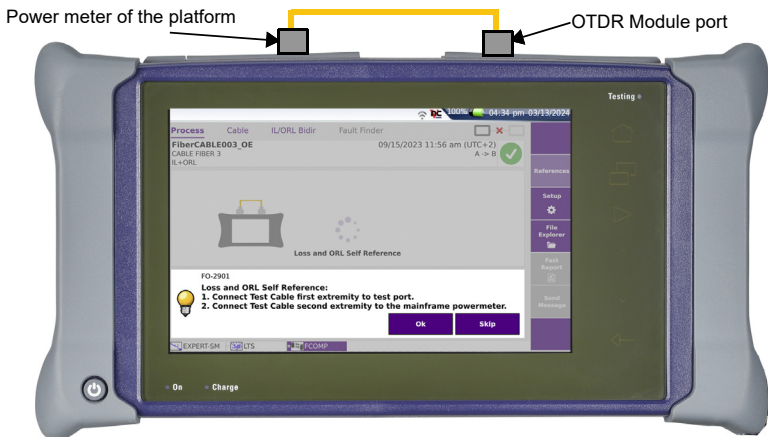

- 2 The zero ORL self reference is necessary for ORL testing. Once the self reference measurement has been carried out, the Zero ORL adjustment can be performed

Connect the test cord from the module port to the non-reflective termination via a mating sleeve.

A Reference accessory kit is delivered with each FiberComplete module. If you don't have a non-reflective termination, a mandrel can be used. Press **Ok** to start referencing.

Figure 17 Zero ORL reference

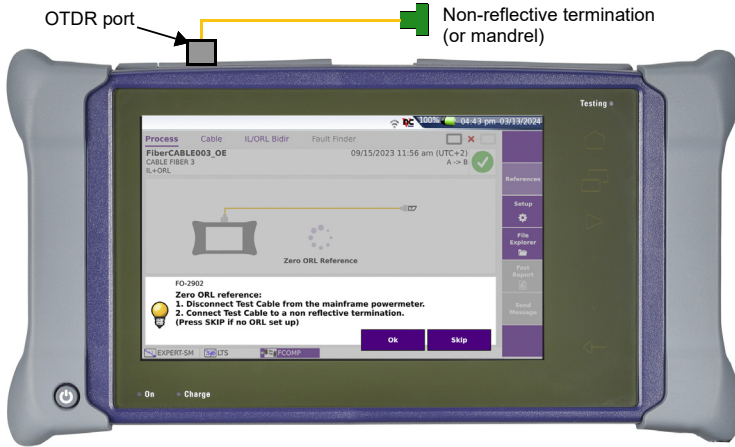

NOTE

Non-reflective terminations are mandatory when bend insensitive test cords and/or PC connectors are used.

Side-by-Side referencing method

The side-by-side referencing is used when the two units are at the same location and is the preferred method for better loss measurement accuracy.

After clicking on **Side/Side**, the wizard will guide you through three steps:

- 1 Loss and ORL reference is still required for ORL testing. Connect the test cord from the module port to the mainframe powermeter and press **Ok** to start referencing.
- 2 The zero ORL reference is necessary for ORL testing. Once the self reference measurement has been carried out, the Zero ORL adjustment can be performed. Connect the test cord from the module port to the non-reflective termination via a mating sleeve. If you don't have a non-reflective termination a mandrel can be used. Press **Ok** to start referencing.

- For the loss reference, connect the test cord from the module port of the local unit, toward the module port of the secondary one via a mating sleeve or adapter. Press **OK** to start referencing.



NOTE

The side by side last step reference: "Loss reference" is bidirectional and performed automatically on both units.

Figure 18 Loss Reference



Loss test (bi-directional IL/ORL + Fault Finder)

This chapter describes the process to perform Loss tests, from configuration of the equipment to the analysis of the results.

The topics discussed in this chapter are as follows:

- ["Configuring the Loss test" page 26](#)
- ["FCOMP-PRO Configuration file" page 33](#)
- ["Performing the tests" page 35](#)
- ["Results screen" page 38](#)
- ["Manual saving and report generation" page 41](#)

Configuring the Loss test

Once FCOMP/FCOMP-PRO function is selected on both units and Loss/ORL references have been correctly performed, the configuration and parameters can be set up.

From the Process page, press **Setup** key.

Figure 19 Process Page

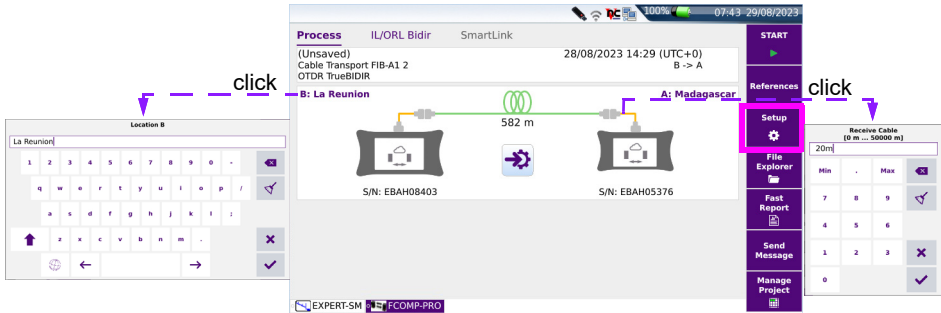

NOTE

Short cuts (loc.ID, Test cable length): directly adjust the locID from both locations and test cables length.

Each menu can be setup manually, however pre-defined VIAVI SmartConfigs and previously saved, user-defined, configurations are also available via the key **Load Config.**

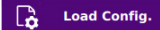

VIAVI Pre-defined configuration files are:

- IL ORL
- IL ORL Unidir OTR
- TrueBIDIR
- IL ORL TrueBIDIR
- IL ORL Fault Finder

Test Cables parameters

Figure 20 Test Cables parameters

28/08/2023 1	Auto-set	START
	Load Config.	References
	Save Config.	Setup
Launch Cable	Test Cables	File Explorer
No		Fast Report
Receive Cable	IL/ORL	Send Message
No		
Unit	meter	
Table View	Fiber	
	OTDR	
	OTDR Alarms	
	Link Description	
	Report	

- **Launch Cable / Receive Cable**

No: no length is entered for the launch cord/cable.

Length: manually enter the length of the launch cord/cable or use the ruler key  to measure it.

A dialog box prompts the user to connect the launch cable to the test port. This cable must be disconnected from the fiber under test (FUT). Press **Confirm** to do the launch cable measurement. Once the measurement is completed, the distance is automatically entered in the numerical keypad.



NOTE

The length displayed in the Process page is the Fiber Under Test length, thus it excludes the launch and receive cables length setup.

- **Unit** Select the unit for the distance measurement: km / kfeet / miles / meter / feet.
- **Table View** Allows selecting the type of table results to be displayed.
 - **Fiber:** measurement results of one fiber at a time, display in **IL/ORL** tab. (See "[IL/ORL BiDir View](#)" page 39). The report and saved file(s) contain the results of one fiber.
 - **Cable:** measurement pass/fail results of multiple tested fibers display in **Cable** tab. Access to detailed loss/ORL values via the **IL/ORL** tab. The report and saved file(s) contain the results of multiple fibers (except .json format). See "[Cable view](#)" page 38.



NOTE

When **Cable** view is selected the filenaming is force to [Cable ID]. A change of the Cable ID, reset the table and create a new recorded file.

IL/ORL parameters

Figure 21 IL/ORL parameters

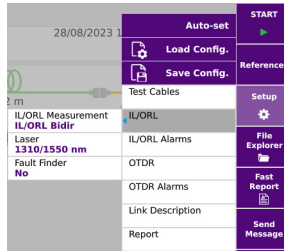

- **IL/ORL Measurement**

IL/ORL Bidir: Insertion Loss and ORL measurements perform from both ends.

IL Bidir.: Insertion Loss measurement performs from both ends

None: Neither IL nor ORL is measured.



A measurement will be performed only if at least IL or IL/ORL parameter is selected.

- **Laser**

select the desired wavelength(s).

All: selection of all wavelength(s) available for this instrument.

- **Fault Finder**

Yes: if a result for Loss and/or ORL exceeds one limit value defined in the **IL/ORL Alarms** (see “[IL / ORL Alarms parameters](#)” on page 29), the Fault Finder function is automatically triggered in order to identify the faulty events.

No: the Fault finder function is not activated (no fault finding occurs, even if one value exceeds the thresholds).



NOTE

If the IL/ORL Alarm thresholds have not been defined, and the **Fault Finder** parameter is set to **Yes**, then the IL/ORL alarms are defined with **Default** values.



If «Fault Finder» parameter is set to Yes, the «OTDR» measurement is automatically set to No, and vice-versa (only if the OTDR function is available on the module).

IL / ORL Alarms parameters

Figure 22 IL/ORL Alarms parameters

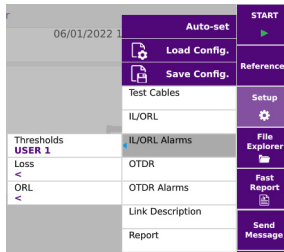

- **Thresholds**
 - None:** No pass/fail thresholds and analysis
 - Default:** VIAVI defined thresholds (**ORL:** < 27 dB & **Loss:** >40 dB for each wavelength)
 - User 1 to 4:** Selectable and user-defined thresholds. Up to 4 thresholds can be saved.
- **Loss** enter a loss threshold, usually corresponding to the optical loss budget, for each wavelength (dB)
- **ORL** enter an ORL threshold for each wavelength (dB)

Link parameters

Fiber link identifiers and description parameters are recorded in the results files which are used for data tracking, analytics, and post processing.

Figure 23 Link Description

Technician Id karime01	Auto-set	START
Job ID	Load Config.	References
Cable Id Cable Transport	Save Config.	Setup
Fiber Id FIB-A1	Test Cables	File Explorer
Fiber Number 2	IL/ORL	Fast Report
Change Fiber Nbr Increment	IL/ORL Alarms	Send Message
Direction B->A	OTDR	Manage Project
Location A Madagascar	OTDR Alarms	
Location B La Reunion	Link Description	
Extremities are differ... No	Report	
Comment <		

- **Technician Id** The user can set a name here.
- **Job Id** enter a job identifier, number or code.
- **Cable Id** This parameter allows entering an identifier for the cable, using the onscreen keyboard.
- **Fiber Id** Select the parameter **Fiber Id** and enter a name for the fiber, using the onscreen keyboard.
- **Fiber Number** Select the parameter **Fiber Number** and modify the parameter using the onscreen keyboard.

The fiber number can be automatically incremented/decremented at each test, as described below.

- **Change Fiber Nbr** Set how the fiber number must be incremented/decremented. For this parameter to be taken into account, the **Auto store** of the **Report** menu must be set to **Yes**.
 - Increment** the fiber number is automatically incremented after each save.
 - Decrement** the fiber number is automatically decremented after each save.
 - No** the fiber number must not be automatically modified.
- **Direction** Select the direction in which the measurement will be performed from origin to extremity (from **Location A** to **Location B**) or from extremity to origin (from **Location B** to **Location A**). You can set different Ids per the direction.

- **Location A** Location A name/address of the fiber cable may be entered here, using the onscreen keyboard.
- **Location B** Location B name/address of the fiber cable may be entered here, using the onscreen keyboard.
- **Extremities are different**
 - No** the **Fiber Id**, **Fiber Number**, **Change Fiber Nbr** and **Cable Id** are the same for both direction A->B and B->A
 - Yes** the **Fiber Id**, **Fiber Number**, **Change Fiber Nbr** and **Cable Id** can be different per direction A->B and B->A. Select the Direction and change these parameters as wished
- **Comment** Click on Comment text box to enter any additional information relevant to the test.

Report parameters

Figure 24 Report parameters

StartLink	Fault Finder	Auto-set	START
08/07/2021 11:00		Load Config.	References
		Save Config.	Setup
File(s) save in:	Test Cables		File Explorer
disk[Function]	IL/ORL		Fast Report
Dir	IL/ORL Alarms		Send Message
File naming	OTDR		
<	OTDR Alarms		
FCDMP PRO Loopback Fib...	Link Description		
Auto store	Report		
Yes			
Report As			
pdf			
Report Layout			
Standard			
Report naming			
FCDMP PRO Loopback Fib...			

- **File(s) save in** Click on the text box to display the keyboard and enter the directory where the measurement results and files will be stored

In the onscreen keyboard, select the Auto pre-defined fields (previously set in the File menu) or, press **abc** key to manually enter directory name and path. Then, press **Enter** to validate.

Example: disk/OTDR/Test

Figure 25 Directory - Onscreen keyboard

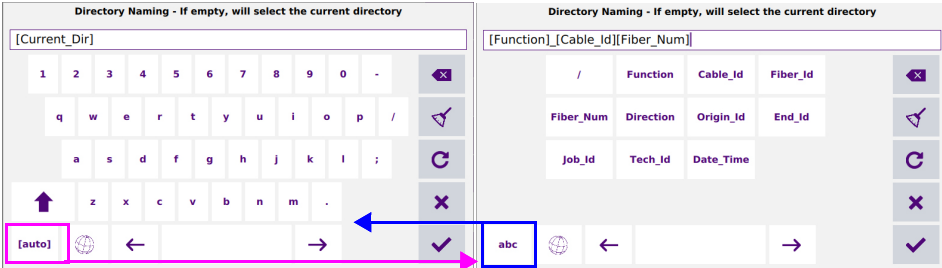

Click on  or leave the box empty to select the Current Directory for file saving.

Press  to validate.

Press  to modify the keyboard language: English / French / German.

- **Dir** This field displays the directory selected/created into which the file(s) will be saved.
- **Filenaming** Select **Filenaming** parameter and click on the text box to modify the file name convention.



Use the onscreen keyboard to view and select the [Auto] pre-defined fields (previously set in File menu) or, press **abc** key to manually enter a file name. Then, press  to validate.

Figure 26 Filenaming - Keyboard (auto)

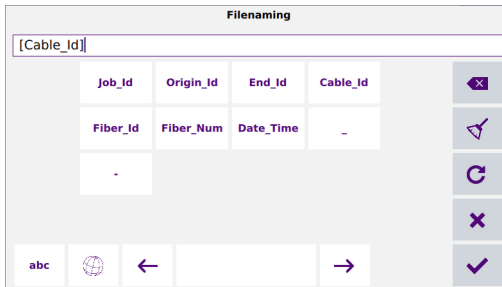

or

Click on  to apply the default file name.

Default Filename for FCOMP results

File naming convention in Fiber View

In Fiber View, the default file naming rule is as follows:

[Fiber_Id] [Fiber_Num]

File naming convention in Cable View

In Cable View, the file naming convention is as follows:

[Cable_Id]

As soon as the Cable Id changes, the result table is cleared and the next tests are stored with the new Cable Id name.

The table view can be modified in the **Setup** page (see [page 27](#)).

- **File naming** The expected file name is displayed in grey under **File naming**.
- **Auto Store** Select **Yes** to store automatically the results according to the file naming settings. If a filename already exists, the user will be prompted to overwrite the "old" result or discard the current result and keep the "old" one.
- **Report As** Select the report format to be generated:
 - txt file** select **Yes** to generate a txt file of the results.
 - pdf file** select **Yes** to generate a report in a pdf file.
 - json file** select **Yes** to generate json file(s) compatible with VIAVI test process automation (job manager and StrataSync cloud data management system).

If all parameters are defined with **No**, only .fcpro proprietary file format will be saved.

Copy File/Link To All key

Copy the File and Report menus/fields from FiberComplete PRO application to other active functions. This is not applicable to Expert OTDR function as it is automatically copied.

FCOMP-PRO Configuration file

A pre-defined configuration (one configuration file defined in FCOMP saves both FCOMP and Expert OTDR setup) can be loaded from the setup menu, or the current configuration can be saved in a file.

Saving the parameters from FiberComplete configuration

Once all the setup parameters are configured, it can be saved in a configuration file.

This configuration file can then be recalled for future tests.

To save parameters in a configuration file:



- 1 In the **Setup** menu, press menu key . The onscreen keyboard displays
- 2 Enter a name for the configuration file.

Figure 27 Save Configuration file - Onscreen keyboard

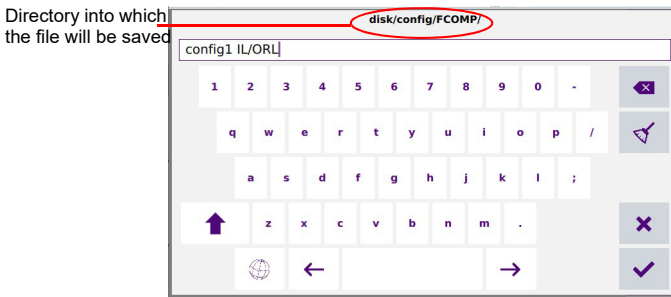

NOTE

Configuration file is saved by default in the directory `disk / config / FCOMP`.

- 3 Press  to validate
The configuration file is saved with the extension «fo_cfg» (icon ).



NOTE

The FiberComplete configuration file includes data storage and measurement settings of FCOMP. This configuration file can be shared and reused with other units.

Sending a message

Once both units are paired via the fiber to be tested, each one can send a message to the other.

This message can be sent to inform the far end technician about launching a test, waiting before launching the test, cleaning the connectors...

To send a message to the distant unit:

- 1 Go to the **Results** page.
- 2 Press  key.

A list of pre-defined messages displays.

Figure 28 Messages list

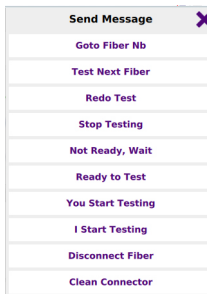

- 3 Select the message to send.



NOTE

If the message "Go to Fiber Nb" is selected, enter the fiber number and validate.

The message displays automatically on the distant unit.

Figure 29 Example of a message received at far end

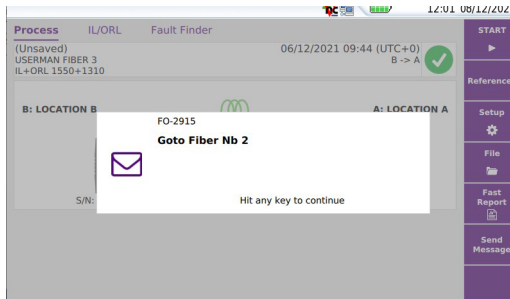

Starting the test

Below are described the steps when bidirectional IL/ORL is selected in the **Setup** menu.



CAUTION

Make sure the **References** softkey is not selected and don't press START REF



NOTE

When a project is opened,  is not available on the remote unit. Indeed, no remote set up transfer would make sense as the project opened on the local unit contains all the set up information.

- 1 If necessary, press  to transfer the complete setup configuration of the local unit to the distant one.
- 2 Press **START** key to launch the test.
 - a The local unit at loc. A setup is automatically transferred to the remote unit at Loc. B..
 - b Unit A and B are performing IL test and mutually exchange their result values
 - c Unit A and B are performing ORL test (using OCWR mode) and mutually exchange their result values.

Figure 30 Test in progress



- d Once all tests are performed, results are displayed on both units. If **Fault Finder** parameter is set to **Yes** and an IL or ORL value reaches one of the user defined thresholds, the Fault Finder starts.

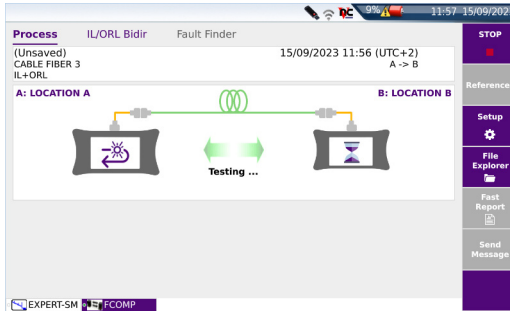

Results screen

Once the tests are completed, the IL/ORL results are displayed and stored on the local unit.

Cable view

If, in **Setup > Analysis**, the parameter **Table View** is set to **Cable**, the **Cable** tab contains below results:

Figure 31 Result Cable View

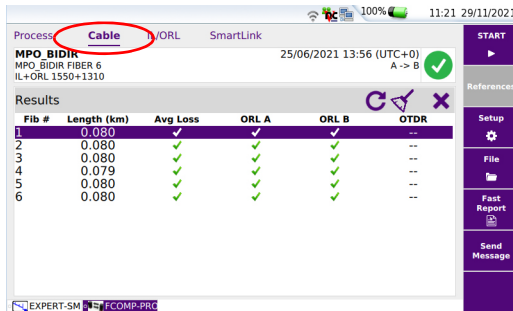

The **Cable View** displays pass/fail results of multiple fibers:

- the length
- the global pass/fail verdict of the average loss of multiple wavelengths
- the ORL A and ORL B pass/fail verdict of multiple wavelengths

Click on to delete the entire table. Press **OK** to confirm.

Select one line and click on to delete only this line. Press **OK** to confirm in the dialog box.

Click on to retest a specific fiber: a dialog box displays asking if you want to retest the same fiber and rewrite the corresponding lines in the table. Press **OK** to confirm.

IL/ORL BiDir View

In the **IL/ORL Bidir** tab, detailed measurement values per wavelength and direction are available:

Figure 32 Results IL/ORL Bidir

Mode CW	Alarms	1310 nm	1550 nm
Length : 407 m			
Loss B->A (dB)	✓	2.14	1.96
Loss A->B (dB)	✓	2.15	1.83
Avg Loss (dB)	✓	2.14	1.89
ORL A (dB)	✓	41.63	45.58
ORL B (dB)	✓	35.47	37.81

The IL/ORL View allows to display results:

- Loss B -> A and loss A -> B at each wavelength
- the average loss at each wavelength
- the ORL A and ORL B at each wavelength
- the Length is displayed on top of the table

NOTE

The length calculation is based by default on the Index of Refraction of G652 G657 fibers which is 1.468. This value can be changed: go to Expert OTDR setup / Display / Index of Refraction.

- For each line the **Alarms** status is indicated with an icon:
 - ✓ if thresholds are defined in the Setup menu: results do not exceed alarm thresholds.
 - ✗ if thresholds are defined in the Setup menu: some results exceed alarm thresholds.
 Click on the icon to display the causes of the alarm.

NOTE

When bidir IL/ORL performed with the laser/powermeter, this indication is displayed: « **Mode: CW** ».

Otherwise, when no Bidir IL/ORL tests are selected in the setup, the unit will still display Bidir IL/ORL calculated by the OTDR with the Indication: « **Mode: OTDR** ».

Process	IL/ORL Bidir
cable543_001_EO	
cable543 Fiber-a1	
None+TrueBIDIR	
Mode OTDR	Alarms

Fault Finder

If, in **Setup > Acquisition**, the **Fault Finder** parameter is set to **Yes**, a Fault analysis is automatically launched, if one value (IL and/or ORL) exceeds the IL/ORL thresholds defined (Splice > 0.3 dB, Connector > 0.75 dB, Reflectance > -32 dB and Bend > 1 dB).

As soon as the Fault Finder finishes its analysis, an easy to interpret table displays. It indicates the attenuation values and/or reflectance of the predominant defects that may have caused the IL / ORL values to fail.

- 1 Select **Fault** tab to display Fault Finder result.

Figure 33 Fault finder result screen

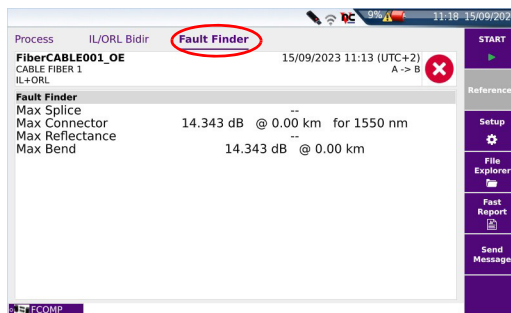

Manual saving and report generation

Once a IL/ORL test is completed, the results are automatically saved (.fcpro format file), if the **Auto Store** parameter has been defined to **Yes** (see [page 33](#)).

.txt / .pdf / .json reports are also generated if the parameter **Report As** is defined (see [page 33](#)).

However, if a modification is done (modification of alarm thresholds, comments ...), the file can be saved manually.

To manually save results and generate a report:

- 1 Press **Fast Report** soft key 
- 2 In the menu, configure the file naming and saving mode (and the report)

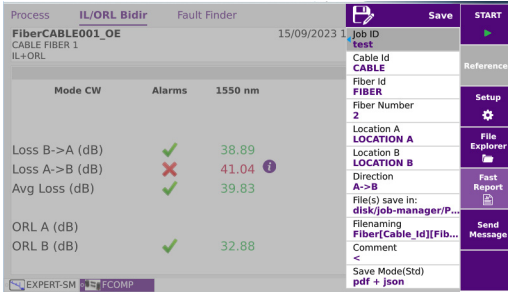

Figure 34 Fast report configuration



- a Define a **Job Id** and **Cable Id**.
- b **Fiber Id**: enter a name for the fiber, using the onscreen keyboard.
- c **Fiber Number**: enter/modify the number of the fiber using the onscreen keyboard.
- d In the **Location A** and **Location B** parameters, enter/modify the name for Origin and Extremity.
- e In the **Direction** parameter, select/modify the direction, to define if the measurement has been performed from Origin to Extremity (**A -> B**) or from Extremity to Origin (**B -> A**).
- f Click on **File(s) save in**: and enter the directory path in the edition keyboard or
 Click on key **C** to define the current directory as directory for file saving.
- g Click on **Filenaming** text box and enter a name for the file in the edition keyboard.
 or
 In the keyboard, click on key **C** to apply the auto filenaming.
- h Click on **Comment** text box to enter a specific comment to the saving.
- i In the **Save Mode** parameter, select:
 - txt file** select **Yes** to generate a txt file of the results.
 - pdf file** select **Yes** to generate a report in a pdf file.

json file select **Yes** to generate json file(s) compatible with VIAVI test process automation (job manager and StrataSync cloud data management system).

If all parameters are set to **No**, only the .fcpro file will be saved.

- 3 Once saving is configured as wished, press **Save** key
- 4 Enter a name for the file in the edition keypad
or
Press  to apply the file name defined in the Setup Report menu, in **File-naming** parameter (see [page 32](#))
- 5 Press  to validate.



NOTE

The .fcpro file and the txt, pdf and / or json files will have the same name.

Once saving is completed, a sound is emitted onto the unit.

Loss test and OTDR (unidir or manual bidir)

(when TrueBIDIR or Loopback SW options not installed)

This chapter describes the process to perform Loss tests and OTDR, from configuration of the equipment to the analysis of the results.

The topics discussed in this chapter are as follows:

- ["Configuring the OTDR test \(unidir and/or manual bidir - no TrueBIDIR or Loopback\)" page 46](#)
- ["Starting the test" page 49](#)
- ["OTDR Results screen" page 50](#)
- ["Manual otdr saving and report generation" page 51](#)

Configuring the OTDR test (unidir and/or manual bidir - no TrueBIDIR or Loopback)

Once FCOMP/-PRO function is selected on both units and references have been performed, the configuration and parameters can be set up.

From Process page, press **Setup** key to access the menus..

In this chapter only the OTDR test configuration is described, as well as specific parameters from Report setup; refer to [Chapter 3](#) for configuration of the other parameters.

OTDR parameters

Figure 35 OTDR Setup

Without TrueBIDIR or Loopback software options installed With TrueBIDIR or Loopback software options installed

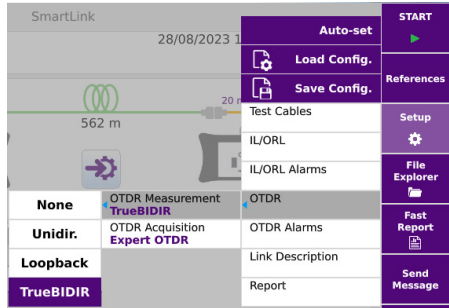
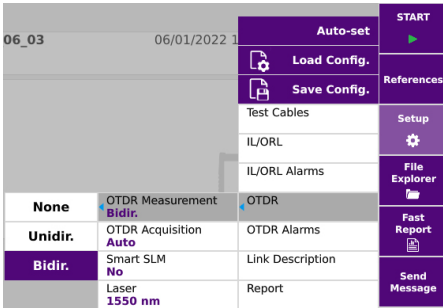

- OTDR Measurement**
 - None.:** No OTDR measurement is performed.
 - Unidir.:** OTDR measurement is performed from one direction only, from the unit where the START is initiated. Unidir OTDR without IL/ORL is not allowed. For only OTDR acquisitions, go to **Expert-OTDR** app.
 - Bidir.:** Each unit performs an OTDR measurement. OTDR traces are not exchanged and remain stored on each unit. A post processing is necessary to get the Bi-directional analysis and calculation. For full automation: install TrueBIDIR or Loopback software. see [Chapter 6 on page 71](#)

- **OTDR Acquisition**

- **Auto**

Laser: can be set by the user.

Pulse/ Range/ Resolution/ Acquisition time are automatically defined, based on the fiber link length auto measurement.

The following fields (not visible) are by default set to:

Network config : Point to Point

Connector test: Yes & continue

Include link start connector: Yes

Include link end connector: Yes

- **Manual**

Laser/ Pulse/ Acquisition time can be set by the user.

Range / Resolution are automatically defined.

The following fields (not visible) are by default set to:

Network config : Point to Point

Connector test: Yes & Continue

Include link start connector: Yes

Include link end connector: Yes

- **Expert OTDR**

The OTDR set up is 100% done in **Expert-OTDR** app for full OTDR set up adjustment.

See OTDR user manual for more details.

OTDR Alarms parameters

- 1 Once the Setup menu is opened, press **Alarms OTDR** to configure the alarms parameters for the OTDR acquisition.

- **Alarm Level** define the alarm level to apply for OTDR acquisition: **None / Fail / Warning**.

If **Fail** level is defined, configure the **Threshold** parameters:

- **Thresholds** select the user defined thresholds to be used: **User 1 / User 2 / User 3 / User 4** and enter limits for:
 - **User:** enter a threshold for each wavelength (dB) and enter an **ORL** threshold for each wavelength (dB)
 - **None:** no alarm thresholds will be applied to otdr results.

- **TIA-568 3 / TIA-568 3.RL35 / ISO/IEC 11801 2010 or 2014 / ISO/IEC 14763-3 2019 / IEC 61280-4-5 (2020) / Default:** Select one of this parameter to configure the alarm thresholds with predefined values:

Table 6 Singlemode Modules

	Splice Loss	Connector loss	Reflectance	Slope	ORL	Mux/Demux
Default	> 0.20 dB	> 0.50 dB	> - 35 dB	> 1.00 dB/km	< 27 dB	No
TIA-568.3	> 0.30 dB	> 0.75 dB	No	> 1.00 dB/km	No	-
TIA-568.3 RL35		> 0.75 dB	> - 35 dB	> 1.00 dB/km		-
ISO/IEC 11801 (2010)		> 0.50 dB	> - 35 dB	> 0.40 dB/km		-
ISO/IEC 14763-3 (2014)		> 0.75 dB	No	> 0.40 dB/km		-
ISO/IEC 14763-3 (2019)		> 0.75 dB	> - 35 dB	> 0.40 dB/km		-
IEC 61280-4-5 (2020)		> 0.75 dB	> - 35 dB	> 0.40 dB/km		-

If **Warning** level is defined, configure the values above which alarms occur for **Splice Loss, Connector Loss** and **Reflectance** parameters.

See OTDR User Manual for more information on alarms configuration.

The following rules apply between the Alarms set up in Fcomp app & results displayed in Fcomp app & Expert OTDR app.

Table 7 Alarms set up in Fcomp

Test Sequence	OTDR Acq.	FCOMP app Alarms	Expert OTDR app Alarms
IL/OLR + unidir OTDR	Auto	Set by the user	By default: same as Alarms in FCOMP
	Manual		
	Expert OTDR	By default: None	Set by the user
Alarm displayed in →		FCOMP Smart link FCOMP report: page 2	Expert Unidir Trace FCOMP report: traces

Report parameters

The following parameters are available exclusively if the OTDR measurement set up is not **None** (see "OTDR parameters" page 46).

- **File content** In this parameter, select the file content for traces saving:
 - **All Traces** in case of traces in overlay, all traces are saved in one single file (.fcpro extension).
 - **One and All Traces:** in case of traces in overlay, each trace is saved (.sor format) and all traces are saved in one single file.

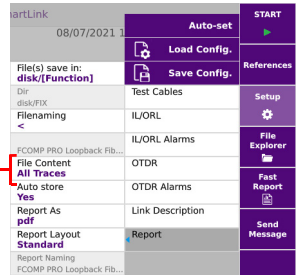

Starting the test

Below are described the steps when bidirectional IL/ORL and OTDR test are selected in the **Setup** menu.



CAUTION

Make sure the References softkey is not selected and don't press START REF!

Press **References** key again to unselect it and return to the standard Process page.



- 1 If necessary, press  to transfer the configuration of this unit to the distant unit.
- 2 Press **START** key to launch the test.
 - a The configuration is automatically transfer to the distant unit, if the key  has not been pressed previously.
 - b Unit A and B are performing IL test and mutually exchange their result values
 - c Unit A and B are performing ORL test (using OCWR mode) and mutually exchange their result values.
 - d If OTDR parameter is set to **Yes**, the OTDR acquisition starts.

Figure 36 Test in progress



OTDR Results screen

Once the test sequence is completed, a SmartLink tab displays the uni-directional OTDR results.

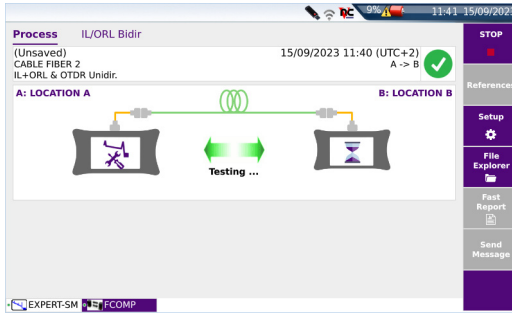
Figure 37 SmartLink View

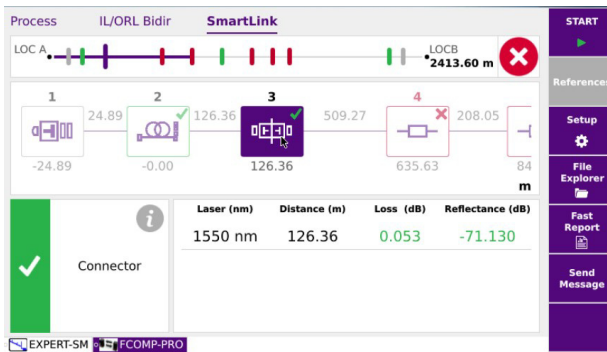

To access the OTDR traces, select the Expert OTDR tab at the bottom of the screen.

For results screen of IL/ORL and Cable, see ["Results screen" page 38](#).

Figure 38 OTDR results - Manual «Bidir OTDR» selected

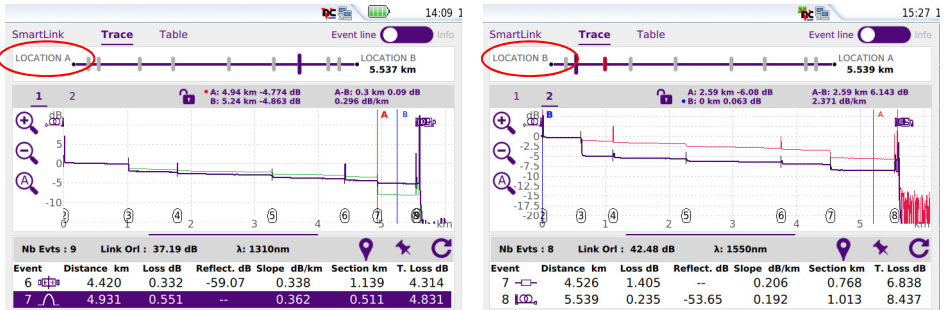

In bidirectional mode:

- The OTDR results trace for acquisition performed from Location A to Location B is stored on the local unit (Location A).
- The OTDR results trace for acquisition performed from Location B to Location A is stored on the remote unit (Location B).

The end of fiber is re-calculated and re-positionned based on the far end unit internal launch cable (~30m). This is especially visible on short links where a short pulsewidth may be used.

For more information on trace results, refer to OTDR Module User Manual.

Manual otdr saving and report generation

Saving traces and creating a report

Once the results page is displayed, the results can be saved and a report can be generated directly from the results screen.

For information on report generation for IL/ORL results, see [“Manual saving and report generation” on page 41](#).

Saving and report can have been automatically generated if, in the file configuration, the **Auto Store** parameter has been set to **Yes** from Setup menu of the OTDR with the appropriate **Save Mode**: see OTDR User Manual.

To generate a report:



- 1 Press **Fast Report** soft key .
A menu displays under the trace.
- 2 In the menu, configure the file saving mode (and the report)

Figure 39 Fast report configuration



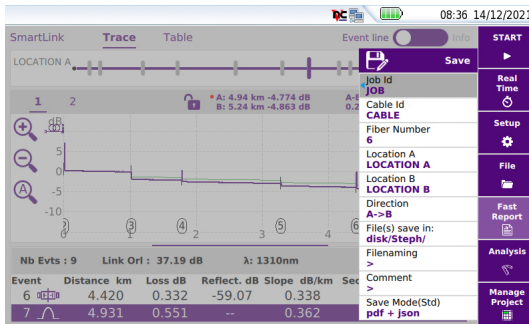

- a If wished, define/modify the name for the Job, clicking on **Job Id** and on the text box to display the keyboard.
- b If wished, define/modify the name for the Cable, clicking on **Cable Id** and on the text box to display the edition keypad.
- c Modify the **Fiber Number**.
- d In the **Location A** and **Location B** parameters, enter/modify the name of Origin and Extremity.
- e In the **Direction** parameter, select/modify the direction, to define if the measurement has been performed from Origin to Extremity (**A -> B**) or from Extremity to Origin (**B -> A**).
- f Click on **File(s) save in:** and enter the directory path in the edition keyboard
or
Click on key  to define the current directory as directory for file saving.
- g Click on **File naming** text box and enter a name for the file in the onscreen keyboard.
or

In the onscreen keyboard, click on key  to apply the auto filenaming.

- h** Click on **Comment** text box to enter a specific comment to the saving.
- i** In the **Save Mode** parameter, select:
 - txt file** select **Yes** to generate a txt file of the results.
 - pdf file** select **Yes** to generate a report in a pdf file.
 - json file** select **Yes** to generate json file(s) compatible with VIAVI test process automation (job manager and StrataSync cloud data management system).

If all parameters are defined with **No**, only the .fcpro file will be saved.

- 3** Once saving is configured as wished, press **Save** key  **Save** .
- 4** Enter a name for the file in the onscreen keyboard.
or
Press  to apply the file name defined in the Setup screen, in **Filenaming** parameter: [Fiber Id][Fiber_Num].
- 5** Press  to validate

Once saving is completed, a sound is emitted onto the Platform.

The pdf report is composed of two files: the pdf report for 1st Fiber and the pdf report for 2nd fiber.



NOTE

The file and the report are saved in the last storage media and directory selected.

Opening a report

- 1** To open the report, press **File Explorer** key
- 2** In the **Explorer** page, in the directory selected, select the file of the report.
For the txt file:txt
For the pdf file:pdf
- 3** Press **Load**.
The file opens on the equipment.

Figure 40 Example of PDF report

		Cable Id : aaa		Fiber Id/Number : bbbb 5		
		Location A : lyon		Location B : saint etienne		
		Job ID :		Technician Id :		
		Switch Port : #2				
Date : 08/09/2023 08:56 (UTC+0)						
Mainframe's model		Module's model		Calibration date		Switch's model
B : MTS 4000 V2 (S/N EBAH08403)		4138 FB65-FCOMP (S/N EMAW00474)		24/05/2023		41MPO125M (S/N 114)
A : MTS 4000 V2 (S/N EBAH05376)		4138 FB65-FCOMP (S/N EMAW00124)		25/05/2023		41MPO125M (S/N 210)
Test Setup						
IL/ORL		1310+1550 nm				A <- B
OTDR		1310+1550 nm				
Alarms						
Threshold IL/ORL measurement		1310(nm)		1550(nm)		
Default		Loss (dB) >40.0		ORL (dB) >40.0		
Threshold OTDR measurement		ORL (dB) <27.0		Reflectance (dB) <27.0		
Default		Connector Loss (dB) >0.50		Splice Loss (dB) >0.20		Slope (dB/Km) >1.00
Reference						
References : 07/09/2023 15:40						
Switch Port		Switch Port : #2				
#2		1310 nm		Loss Ref. Type Default		Loss Ref. Level (dBm) -9.50
		1550 nm		Default		ORL Power Lev. (dBm) -9.50
		1625 nm		Default		ORL Zero (dB) 45.00
						45.00
IL/ORL & Length Results						
Mode CW						
Length	Wavelength	Loss B->A	Loss A->B	Avg Loss	ORL A	ORL B
53 m	1310	0.22	0.30	0.26	35.63	39.03
	1550	0.30	0.21	0.25	>55.00	>55.00
Page Number : 1						



CAUTION

To modify the VIavi logo, set by default on the header of the pdf report, save your logo in a jpg file called `logo.jpg` and place it to the root of the disk:
`disk > logo.jpg`.



NOTE

A pdf report can also be generated from the File Explorer page onto the equipment (see user manual of the equipment).

Loopback OTDR

This chapter describes the use of FiberComplete PRO - Bi-Directional OTDR Loopback method.

The topics discussed in this chapter are as follows:

- ["Configuring the Loopback Test" page 56](#)
- ["Performing the tests" page 63](#)
- ["Results screen" page 64](#)
- ["Saving results and generating a report" page 67](#)

Configuring the Loopback Test

Once the license is installed onto the equipment (see Base Unit User Manual):

- 1 Validate the icon  on the **Home** page.
- 2 Press **SETUP** to display the configuration screen.

Test Cables parameters

- 1 In the **Setup** menu, press **Test Cables**.
- 2 Once the Test Cables menu is displayed, configure the parameters for Loopback OTDR acquisitions to be performed.

Figure 41 Loopback - Process page

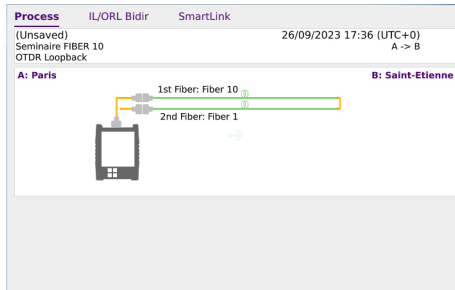

Figure 42 Test Cables parameters



29/03/2021 1	Auto-set	START
	Load Config.	
	Save Config.	
Launch Cable No	Test Cables	Setup
Receive Cable No	OTDR	OTDR
Loopback Cable 0.000km	Alarms Loss	File Explorer
Unit km	OTDR Alarms	Fast Report
Remote Unit Search Default scan	Link Description	
	Report	

Launch Cable End / Receive Cable Start

No All the results are displayed and referenced on the basis of the board of the module.



Length Click on **Length** to display the numeric keyboard and:

- enter a length (Min= 0 / Max=50 km / 164.042 kfeet / 31.075 miles)
or

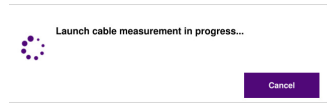
- Click on  to perform a measurement of the launch cable: a dialog box informing to connect the launch cable displays. Press  once it is connected to start the measurement.



Once the measurement is completed, the distance is automatically entered in the numeric keypad.

Click on  to validate (or on  to cancel).

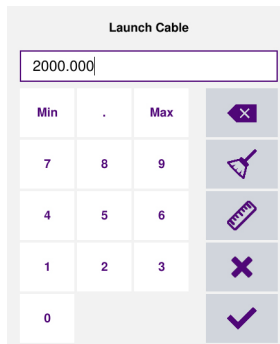

Launch Cable			
2000.000			
Min	.	Max	
7	8	9	
4	5	6	
1	2	3	
0			

Loopback Cable

Click on the text box to define the loopback cable length: if known, enter the length or click on the key  to calculate the length: press **Confirm** to validate.

Unit

Select the unit for the distance measurement: **km** / **kfeet** / **miles** / **meter** / **feet**.

OTDR parameters

OTDR Measurement

Select **Loopback** to be able to perform the otdr measurement in loopback mode.

OTDR Acquisition

Select the type of acquisition to be performed:

Auto The acquisition is automatically performed using the best pulse, range and resolution.

Expert OTDR The acquisition is performed according the parameters configuration for in Expert OTDR mode (see OTDR User Manual for more information on Expert OTDR configuration).).

Laser

The acquisition will be carried out on the wavelength(s) selected (for multiple-wavelength modules). In case of a multi-wavelength module, select **All** to perform a measurement for all the wavelengths available (this parameter visible exclusively on modules with one single OTDR port). The possible values depend on the module used.

Alarm parameters

- 1 In the **Setup** menu, press **Alarms Loss**.
- 2 Once the **Alarms Loss** menu is displayed, configure the loss pass/fail thresholds.

Figure 43 Loopback Loss Alarm Thresholds

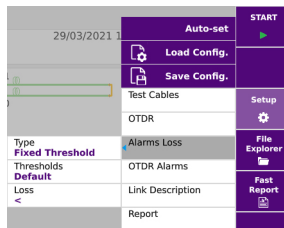

Type select if the alarms must be defined with **Fixed Thresholds** or **Variable thresholds**.

If **Fixed thresholds** are defined, configure the parameter **Thresholds**:

- Select the user defined thresholds to be used: **User 1 / User 2 / User 3 / User 4** and enter limits for **Loss** for each wavelength (dB)
- Or select the **Default** parameter to define thresholds by default for **Loss** value: > 40 dB for each wavelength
- Select **None** if alarm thresholds must not be defined.

If **Variable Thresholds** are defined, only pre-set values are defined per fiber length section. (See a VIAVI representative to get a customization of these parameters).



NOTE

The selected pass/fail thresholds will apply to the average slope loss, event loss and max reflectance.

OTDR Alarms parameters

- 1 Once the Setup menu is opened, press **Alarms OTDR** to configure the alarms parameters for the OTDR acquisition.

Thresholds select the user defined thresholds to be used: **User 1 / User 2 / User 3 / User 4** and enter limits for:

- **User**: enter a threshold for each wavelength (dB) and enter an **ORL** threshold for each wavelength (dB)
- **None**: no alarm thresholds will be applied to otdr results.
- **TIA-568 3 / TIA-568 3.RL35 / ISO/IEC 11801 2010 or 2014 / ISO/IEC 14763-3 2019 / IEC 61280-4-5 (2020) / Default**: Select one of this parameter to configure the alarm thresholds with predefined values:



NOTE

The selected pass/fail thresholds will apply to the average slope loss, event loss and max reflectance.

Table 8 Singlemode Modules

	Splice Loss	Connector loss	Reflectance	Slope	ORL	Mux/ Demux
Default	> 0.20 dB	> 0.50 dB	> - 35 dB	> 1.00 dB/km	< 27 dB	No

Table 8 Singlemode Modules

	Splice Loss	Connector loss	Reflectance	Slope	ORL	Mux/Demux
TIA-568.3	> 0.30 dB	> 0.75 dB	No	> 1.00 dB/km	No	-
TIA-568.3 RL35		> 0.75 dB	> - 35 dB	> 1.00 dB/km		-
ISO/IEC 11801 (2010)		> 0.50 dB	> - 35 dB	> 0.40 dB/km		-
ISO/IEC 14763-3 (2014)		> 0.75 dB	No	> 0.40 dB/km		-
ISO/IEC 14763-3 (2019)		> 0.75 dB	> - 35 dB	> 0.40 dB/km		-
IEC 61280-4-5 (2020)		> 0.75 dB	> - 35 dB	> 0.40 dB/km		-

See OTDR User Manual for more information on alarms configuration.

Table 9 Alarms set up in Fcomp

Test Sequence	OTDR Acq.	FCOMP app Alarms	Expert OTDR app Alarms
Loopback	Auto	Set by the user	Set by the user
	Expert OTDR		
Alarm displayed in →		FCOMP Smart link FCOMP pdf report: page 1	Expert Unidir Trace

Link Description parameters

Only different or extra parameters than the otdr link parameters are described (see OTDR User Manual for a complete description of all the available parameters).

1st Fiber / 2nd Fiber

Click on **1st fiber** or **2nd Fiber** and in the sub-menu

Fiber Id

Select the **Fiber Id** and modify if necessary the fiber name.

Fiber Id
Fiber
Fiber Number
174
Change Fiber Nbr
Increment
Cable Id
fix

Fiber Number	Select the Fiber number parameter and click on left or right arrow to modify the Number
Change Fiber Nbr	Select Change Fiber Nbr and select
Increment	the fiber number is automatically incremented at each new file-save.
Decrement	the fiber number is automatically decremented at each new file-save
User defined	Use Edit Number softkey to enter the increment/decrement value for fiber number.
	Note: to decrement the number, enter the sign «-» before the number. Example: -1. Min: -999 / Max: 999 / Auto: 0
No	the Fiber number must not automatically modified.
Cable Id	Select the Cable Id parameter and enter/modify the cable identifier.

Saving configuration

Once the File and Measurement parameters are configured, it can be saved in a configuration file.

This configuration file can then be recalled for future acquisition in Loopback mode.



NOTE

The configuration from Loopback Setup page can be saved exclusively if the ExpertOTDR function is selected at the same time on the Home page.

To save parameters in a configuration file:

- 1 In the **Setup** menu, press menu key  .
An edition keyboard displays
- 2 Enter a name for the configuration file.



Figure 44 Save Configuration file - Edition keypad

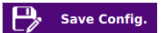
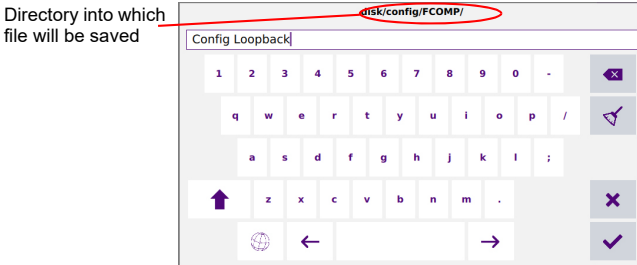

NOTE

Configuration file is saved by default in the directory `disk / config / FCOMP`.

3

Press  to validate
The configuration file is saved with the extension «fo_cfg» (icon .



NOTE

The configuration file includes data storage and measurement settings of Loopback and Expert OTDR. This configuration file can be shared and reused with other units.

Loading a configuration file

The configuration file includes OTDR and FCOMP setup and file parameters.

To load a configuration file previously created and apply parameters to new tests:

- 1 Press **LOAD CONFIGURATION** key  **Load Config.**
- 2 Select the configuration file in the wished directory.
- 3 Press **Load Config.**
 - Press **SETUP** key to display the OTDR and FCOMP acquisition parameters saved in the configuration file.

You can modify some acquisition or file storage parameters, and save them in a new configuration file (see “Saving configuration” on page 61).



NOTE

Some configuration files are available in the Platform: press **FILE** and select **disk > config > FCOMP**.

Performing the tests

Below are described the steps when Loopback OTDR measurement has been selected and inspection of the connectors has been validated.

- 1 Connect a **loopback cable** at each fiber end

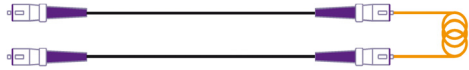

- 2 Connect a **launch cable** at Origin - 1st fiber and a **receive cable** at Origin - 2nd fiber

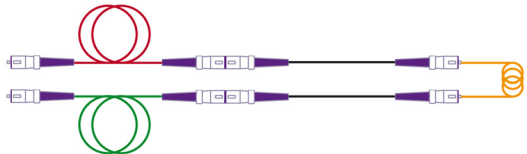

- 3 Connect the **launch cable** to the Module.
- 4 Launch the measurement from **Launch cable** toward **Receive cable**

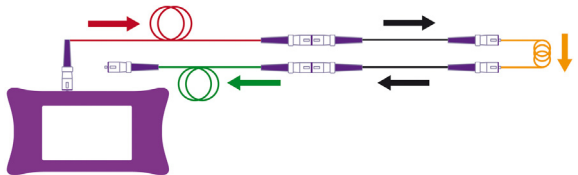

Once completed, a pop up message displays on the Platform:

Connect to Fiber 8 and press OK to start the OTDR Measurement.



OK

- 5 Follow the instructions displayed: connect the **receive cable** to the Module of the Platform.
- 6 Press **Start** to launch the measurement from **Receive cable** toward **Launch cable**

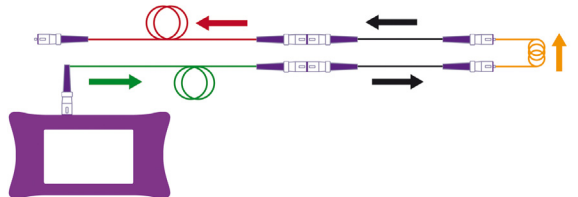

Once measurement is completed, the results display.

Results screen

Once the tests are completed, the results screen displays, both with Loopback view and with OTDR result trace.

Results page

The Results page can display either:

- the **Process** view, displaying the graphical representation of the measurement and the Loss results for each fiber
or
- the **Summary** view, for the 1st and the 2nd fiber.
or
- the **SmartLink** view, with a graphical representation of the link.

Process View

Figure 45 Result Loopback- Process view

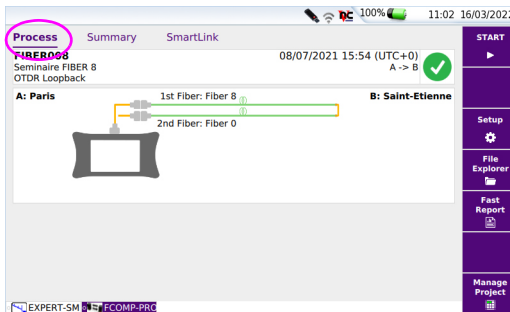

On the upper part, a graphical representation of the installation for the test is displayed, with the Identifier for each component (name of the location and of the loopback, fiber numbers...).

Summary view

The Summary tab allows to display a summary table of the loss measurement for the first and second fiber.

The results displayed in green or red are values for which a threshold has been defined: in green, the value does not exceed the thresholds defined in OTDR setup, in red it exceeds the thresholds. See “Alarm parameters” on page 58.

Figure 46 Summary View

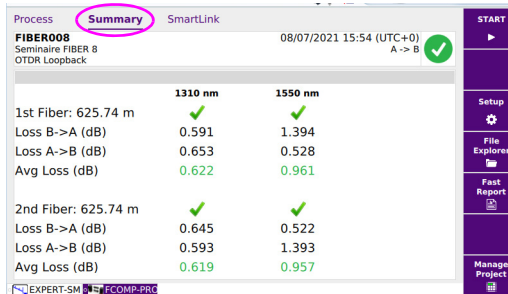

SmartLink view

Click on **SmartLink** to display a SmartLink view of each measured fiber:

Select **1st Fiber** or **2nd Fiber** 1st Fiber 2nd Fiber 1st Fiber 2nd Fiber to display the results for the first or second fiber.

Figure 47 SmartLink View

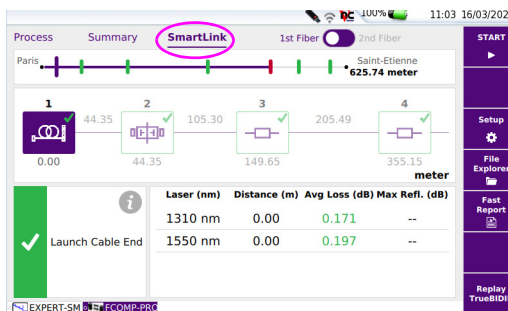

The event is displayed with a red icon if it is above the alarm thresholds defined in the setup menu.

A green icon is displayed if it lies within the thresholds.

OTDR results trace / SmartLink results

OTDR Results trace

In Expert OTDR tab, the OTDR results traces are displayed with the results table.

Figure 48 OTDR Results trace

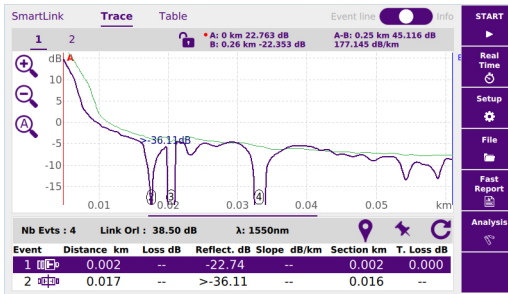

The results displayed in green or red are values for which a threshold has been defined: in green, the value does not exceed the thresholds defined in OTDR setup, in red it exceeds the thresholds. See [“Configuring the Alarms parameters”](#) on page 26.

SmartLink view

Press **SmartLink** tab to display the SmartLink view of the results.

Figure 49 SmartLink results page

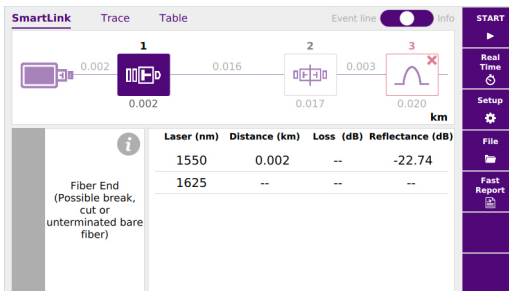

Saving results and generating a report

Once the results page is displayed, the results can be saved and a report can be generated directly from the results screen.

Saving and report can have been automatically generated if, in the file configuration, the **Auto Store** parameter has been set to **Yes** (see [page 33](#)) with the appropriate **Save Mode**.

Saving results and creating a report from results page

To generate a report:

- 1 Press **Fast Report** soft key.
A menu displays under the trace.
- 2 In the menu, configure the file saving mode (and the report)

Figure 50 Fast report configuration

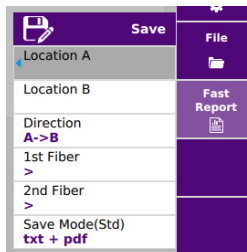

- a In the **Location A** and **Location B** parameters, enter/modify the name of Origin and Extremity.
- b In the **Direction** parameter, select/modify the direction, to define if the measurement has been performed from Origin to Extremity (**A -> B**) or from Extremity to Origin (**B -> A**).
- c Click on **1st fiber** or **2nd Fiber** and in the sub-menu
 - Select the **Fiber number** parameter and click on left or right arrow to modify the Number
 - Select the **Cable Id** parameter and enter/modify the cable identifier
- d In the **Save Mode** parameter, select:

- txt file** select **Yes** to generate a txt file of the results.
- pdf file** select **Yes** to generate a report in a pdf file.
- json file** select **Yes** to generate json file(s) compatible with VIAVI test process automation (job manager and StrataSync cloud data management system).

3 Once saving is configured as wished, press **Save** key

4 Enter a name for the file in the edition keypad

or

Press  to apply the file name defined in the Setup screen, in **File naming** parameter: [Fiber Id][Fiber_Num].

5 Press  to validate

Once saving is completed, a sound is emitted onto the Platform.

The pdf report is composed of two files: the pdf report for 1st Fiber and the pdf report for 2nd fiber.



NOTE

The file and the report are saved in the storage media and directory defined in the setup screen (see [page 31](#)).

Opening a report

1 To open the report, press **File** key

2 In the **Explorer** page, in the directory selected, select the file of the report.

For the txt file: *trace file_sor.txt*

For the pdf file: *trace file.sor.pdf*

3 Press **Load**.

The file opens on the equipment.

Figure 51 Report from Loopback measurement

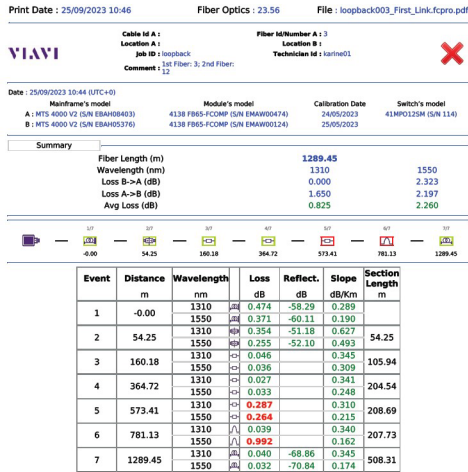

CAUTION

To modify the VIAVI logo, set by default on the header of the pdf report, save your logo in a jpg file called logo.jpg and place it to the root of the disk:
 disk > logo.jpg.



NOTE

A pdf report can also be generated from the File Explorer page onto the equipment (see user manual of the equipment).

TrueBIDIR OTDR

(automated on board bi-directional OTDR)

This chapter describes the use of the TrueBIDIR software option, when the software license has been purchased with an OTDR module.

The topics discussed in this chapter are as follows:

- ["Configuring the True Bidirectional Test" page 72](#)
- ["Performing the tests" page 76](#)
- ["Results screen" page 76](#)
- ["Adding an event with \[Replay TrueBIDIR\] function" page 78](#)
- ["Changing an event code with \[Replay TrueBIDIR\] function" page 80](#)
- ["Manual saving and report generation" on page 81](#)

Configuring the True Bidirectional Test

Once the license is installed onto the equipment (see Base Unit User Manual):

- 1 Validate the icon  on the **Home** page.
- 2 Press **SETUP** to display the configuration screen.

Test Cables parameters

- 1 In the **Setup** menu, press **Test Cables**.
- 2 Once the **Test Cables** menu is displayed, configure the parameters for otdr acquisitions to be performed.

Figure 52 Acquisition parameters

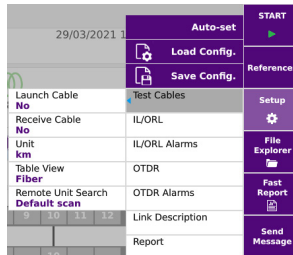

- **Launch Cable / Receive Cable**

No: no length is entered for the launch cord/cable.

Length: manually enter the length of the launch cord/cable or use the ruler key  to measure it.

A dialog box prompts the user to connect the launch cable to the test port. This cable must be disconnected from the fiber under test (FUT). Press **Confirm** to do the launch cable measurement. Once the measurement is completed, the distance is automatically entered in the numerical keypad.



NOTE

The length displayed in the Process page is the Fiber Under Test length, thus it excludes the launch and receive cables length setup.

- **Unit** Select the unit for the distance measurement: km / kfeet / miles / meter / feet.
- **Table View** Allows selecting the type of table results to be displayed.
 - **Fiber:** measurement results of one fiber at a time, display in **IL/ORL** tab. (See "[IL/ORL BiDir View](#)" page 39).
The report and saved file(s) contain the results of one fiber.
 - **Cable:** measurement pass/fail results of multiple tested fibers display in Cable tab. Access to detailed loss/ORL values via the **IL/ORL** tab. The report and saved file(s) contain the results of multiple fibers (except .json format). See "[Cable view](#)" page 38.



NOTE

When **Cable** view is selected the filenaming is force to [Cable ID]. A change of the Cable ID, reset the table and create a new recorded file.

OTDR parameters

Laser

The acquisition will be carried out on the wavelength(s) selected (for multiple-wavelength modules). In case of a multi-wavelength module, select **All** to perform a measurement for all the wavelengths available (this parameter visible exclusively on modules with one single OTDR port). The possible values depend on the module used.

OTDR Measurement

Select **TrueBIDIR** to be able to perform the otdr measurement in bi-directional mode.

- **Auto**
 - Laser:** can be set by the user.
 - Pulse/ Range/ Resolution/ Acquisition time** are automatically defined, based on the fiber link length auto measurement.
 - The following fields (not visible) are by default set to:
 - Network config :** Point to Point
 - Connector test:** Yes & continue
 - Include link start connector:** Yes
 - Include link end connector:** Yes
- **Manual**
 - Laser/ Pulse/ Acquisition time** can be set by the user.
 - Range / Resolution** are automatically defined.

The following fields (not visible) are by default set to:

Network config : Point to Point

Connector test: Yes & Continue

Include link start connector: Yes

Include link end connector: Yes

– **Expert OTDR**

The OTDR set up is 100% done in **Expert-OTDR** app for full OTDR set up adjustment.

See OTDR user manual for more details.

Alarms OTDR parameters

- 1 Once the Setup menu is opened, press **Alarms OTDR** to configure the alarms parameters for the OTDR acquisition.

Thresholds select the user defined thresholds to be used: **User 1 / User 2 / User 3 / User 4** and enter limits for:

- **User**: enter a threshold for each wavelength (dB) and enter an **ORL** threshold for each wavelength (dB)
- **None**: no alarm thresholds will be applied to otdr results.
- **TIA-568 3 / TIA-568 3.RL35 / ISO/IEC 11801 2010 or 2014 / ISO/IEC 14763-3 2019 / IEC 61280-4-5 (2020) / Default**: Select one of this parameter to configure the alarm thresholds with predefined values:



NOTE

The selected pass/fail thresholds will apply to the average slope loss, event loss and max reflectance.

Table 10 Singlemode Modules

	Splice Loss	Connector loss	Reflectance	Slope	ORL	Mux/ Demux
Default	> 0.20 dB	> 0.50 dB	> - 35 dB	> 1.00 dB/km	< 27 dB	No

Table 10 Singlemode Modules

	Splice Loss	Connector loss	Reflectance	Slope	ORL	Mux/Demux
TIA-568.3	> 0.30 dB	> 0.75 dB	No	> 1.00 dB/km	No	-
TIA-568.3 RL35		> 0.75 dB	> - 35 dB	> 1.00 dB/km		-
ISO/IEC 11801 (2010)		> 0.50 dB	> - 35 dB	> 0.40 dB/km		-
ISO/IEC 14763-3 (2014)		> 0.75 dB	No	> 0.40 dB/km		-
ISO/IEC 14763-3 (2019)		> 0.75 dB	> - 35 dB	> 0.40 dB/km		-
IEC 61280-4-5 (2020)		> 0.75 dB	> - 35 dB	> 0.40 dB/km		-

See OTDR User Manual for more information on alarms configuration.

Table 11 Alarms set up in Fcomp

Test Sequence	OTDR Acq.	FCOMP app Alarms	Expert OTDR app Alarms
IL/ORL + TrueBIDIR TrueBIDIR	Auto	Set by the user	By default: None
	Manual		Set by the user
	Expert OTDR		
Alarm displayed in →		FCOMP Smart link FCOMP report: page 2	Expert Unidir Trace FCOMP report: traces

For **Link** configuration and configuration file saving, see [Chapter 3: “Link parameters” on page 30](#) and [“FCOMP-PRO Configuration file” on page 33](#).



NOTE

With TrueBidir configuration, the results are automatically saved (the **Auto Store** parameter is defined to **Yes**, and cannot be modified) - see [page 33](#).

Performing the tests

- 1 Referring to measurement principle page 8 and once parameters are set, press START.

The unit where the measurement has been initiated becomes the Master: all its parameters are automatically transferred to the remote unit. The bi-directional OTDR results are computed, analyzed and saved on the Master.

- a Master unit transfers its test settings to the remote unit.
- b The OTDR measurement is performed from the master towards the remote.
- c The OTDR measurement is performed from the remote towards the master
- d All OTDR traces get to the master, so it can align traces A->B with B->A, harmonize events found in each direction, and calculate the True/average loss values.

The multi-wavelengths bi-directional SmartLink view is displayed in FCOMP-PRO tab, and detailed traces for each wavelength and each direction are available in the Expert OTDR tab.

Results screen

Results page

Bi-Directional SmartLink

In  FCOMP-PRO, select the **SmarLink** tab at the top. The screen is split in 3 sections.

The screen displays icon-based representation of the average bi-directional OTDR results. Average loss is automatically calculated based on $(\text{Event loss A->B} + \text{Event loss B->A})/2$ -same for the slope-.

The maximum reflectance of the two directions is automatically compared. Pass/fail status for each element are displayed per OTDR alarms set in FCOMP-PRO.

Figure 53 SmartLink View

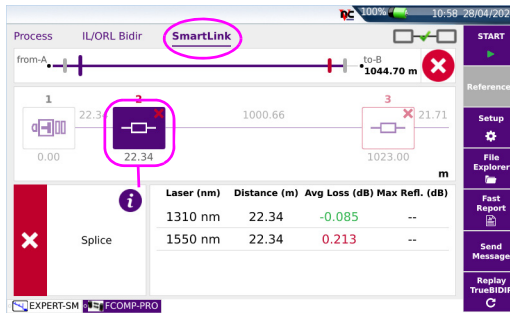

Click on one event on the graphical representation to display the loss and reflectance values for each wavelength, and the event description, at the bottom of the display.

The event is displayed with a red icon if it is above the alarm thresholds defined in the setup menu.

- A green icon is displayed if it lies within the thresholds.
- A yellow icon is displayed if the value is above a «Warning» threshold.

OTDR traces

In **EXPERT-SM**, up to 6 traces can be displayed on the screen: max of 3 traces (1310/1550) per direction. All the traces are visible on the master unit.

Example below: the traces **1 & 2** are 1310/1550 nm from A->B and traces **3 & 4** 1310/1550 nm from B->A. The direction of the traces is displayed in the **Info** line caption.

Figure 54 OTDR results

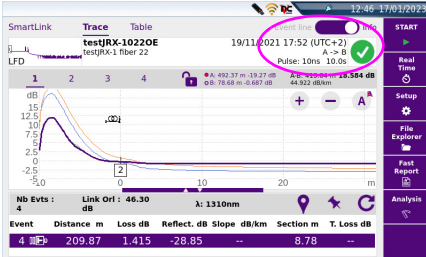

1 & 2: 1310/15550 nm A -> B

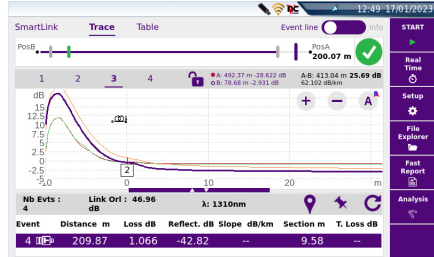

3 & 4: 1310/15550 nm B -> A



NOTE

By clicking on the upper tabs **SmartLink** and **Table** you have access to additional representation of results, but for the selected direction only. The direction can only be changed via the **Trace** view.

Adding an event with [Replay TrueBIDIR] function

Like for unidirectional OTDR acquisitions, adding, modifying or deleting an event can manually be done for TrueBIDIR acquisitions.

Known events which have not been displayed can be added to the OTDR trace to provide a 100% complete, real world view of a fiber link.

Without having to play START again, the [Replay TrueBIDIR] function will automatically regenerate:

- 1 the TrueBIDIR SLM analysis with added events
- 2 the opposite direction Unidir. traces (Remote from Local)



CAUTION

This procedure cannot be done if [Table view] = Cable View is set in Fiber-Complete PRO.



Please make sure [Cable view] = Fiber view is selected.



NOTE

The OTDR traces visible in the Expert OTDR tab correspond to the latest done/measured. To edit previous measurements, load the appropriate .fcpro file (contains IL/ORL and OTDR results and OTDR traces).

To manually add an event:

- 1 Go to Expert-SM app/Trace view.
- 2 Select Trace 1 (first wavelength, from A -> B)
- 3 Set the new event at the location wished:
 - a Zoom in and shift to adjust the display and get the location of the new event.
 - b Set Cursor A or B on this location.
 - c Click on .
 - d The new event is displayed onto the trace and in the table.
- 4 Without moving the cursor, go to trace 2 (second wavelength) and click on  to set an event at the same location.
- 5 CAUTION: Repeat the process for all remaining wavelengths, **only in direction A -> B.**



NOTE

In TrueBIDIR mode, events are automatically set from one direction to another, so there is no need to add manually the event in both directions.

- 6 Once done, go to **FCOMP-PRO** app/**SLM** view
 - 7 Press **Replay TrueBIDIR** key .
- The event previously added in one direction, will be automatically set in the other direction, for all wavelengths, and the bi-directional analysis is redone.
All files and reports are automatically updated.

Figure 55 Adding an event in TrueBIDIR mode



Return to **ExpertOTDR** page to display the new event on the traces B -> A.

Changing an event code with [Replay TrueBIDIR] function

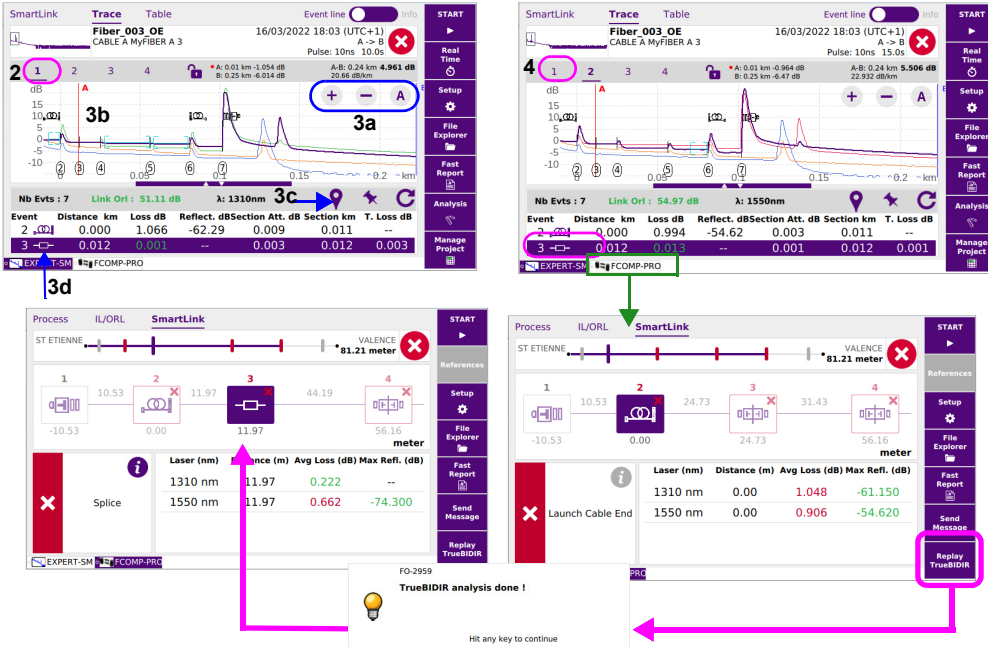

CAUTION

This procedure cannot be done if Cable View is set in FiberComplete PRO. Please make sure Fiber view is selected.

- 1 Go to **Expert-SM** app/ **Trace** view.
- 2 Select one trace, for ex. trace 1 (A->B, wavelength 1).
- 3 Go either to **Smartlink** view or **Trace** view to change the event.

- 4 Make a long press on the event icon, in the results table for **Trace** view or in the **SmartLink** graphical representation.
- 5 Click on event code and modify the event type.
- 6 Once done, go back to Fcomp-Pro page, in the SmartLink upper tab, press **Replay Truebidir** .
Replay TrueBIDIR will resave automatically all files.

Manual saving and report generation

Once a TrueBidir test is completed, the results are saved in:

- .sor files (if “one and all traces” is selected in the set-up)
- .fcpro file (automatically saved)
- .pdf, .json reports (if .pdf or .json have been selected in the set up)

if a display modification has been done such as cursors been added, use **Fast Report** to save the files with the modification .

Saving traces and creating a report

Once the results page is displayed, the results are automatically saved and a report is generated directly from the results screen.

For information on report generation for IL/ORL results, see [“Manual saving and report generation” on page 41](#).



NOTE

- .sor file naming automatically includes: wavelength (1310, 1550, 1625...) and direction: OE for Origin-Extremity, or EO for Extremity-Origin



NOTE

The txt, pdf and json files will have the same name.



NOTE

A pdf report can also be generated from the File Explorer page onto the equipment (see user manual of the equipment).

High Fiber Count

(FCOMP...+ MPO switch + Cable-SLM)

This chapter describes the use of the MPO module switch (designed to handle high fiber count applications) with Cable-SLM software (automatically activated with the installation of the switch).

Cable-SLM will allow to create a test project for every cable to be tested as well as track project progress in real time and save project test data and generate reports right away.

The option activates a new softkey/button **Manage Project** at the bottom right of the Process page.

The topics discussed in this chapter are as follows:

- ["Establishing references for Loss and ORL measurements" page 86](#)
- ["Configuring the MPO Module" page 88](#)
- ["Creating a project for an automatic switch sequence" page 89](#)
- ["Customizing a test sequence" page 92](#)
- ["Launching the project test process" page 93](#)
- ["Results display" page 95](#)
- ["Files and project storage" page 97](#)
- ["Manual saving and report generation" page 99](#)

Establishing references for Loss and ORL measurements

- 1 Make sure the MPO switch module is plugged and active (icon turned yellow on the home page).
- 2 Select the **References** soft key.
2 Referencing methods are available.
 - **Factory Ref.:** fastest process, higher loss uncertainties.
 - **Side by side Ref.:** most accurate method, both test sets must be at the same location during the referencing process.



CAUTION



Once the process of the reference is launched and the reference is performed, never disconnect the test cable from the switch module test port. A good practice is to reference every morning before going on-site.



CAUTION

The end to end polarity has to match the reference polarity (type A with VIAVI test cords).

Factory References

Press the  icon to fill the table with default reference values, measured at the factory. As soon as the icon  is pressed and the table filled with default reference value, the display returns automatically to **Process** page.

The following figure show the default values:

Figure 57 Factory references

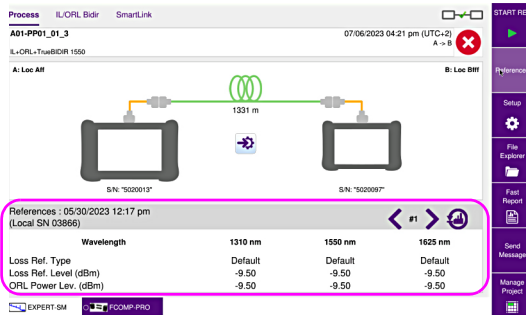

Referencing process with simplex connectors (non native MPO networks), with fanout test cables

- 1 Press **References** , then **START REF** .
- 2 The referencing wizard on the screen is not adapted. Follow the below instructions. Side by side referencing will apply.
 - a **Zero ORL Self reference:**
Do not connect any test jumper to the MPO switch port.
Press **START**.
 - b **Loss and ORL self-reference:**
Connect the MPO reflective terminal accessory directly to the MPO switch port.
Press **START**.
 - c **Loss reference:**
Connect the two fanout test cables with a bulkhead array or with single adaptors.
Press **START** on one unit only.

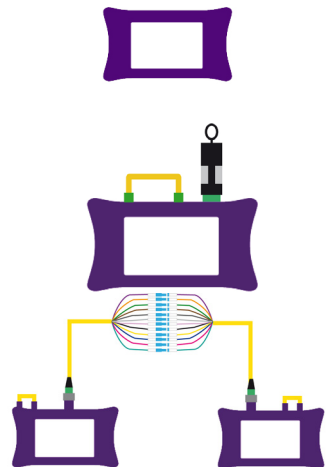

The measured reference values for each fiber/strand of the MPO cable displays.

On the top banner of the table is displayed the fiber number “#N”. The left < and right > arrows allow scanning through the 12 fibers.

Referencing process with MPO native networks (no fanout test cables)

Follow the instructions given by the referencing wizard.

Configuring the MPO Module

Before starting the test, and if a MPO Module switch is installed onto the equipment, it must be activated (by going on the Home page and selecting the MPO switch icon) and configured:

- 1 In **FCOMP-PRO**, go to Project page, and press **Setup**.
- 2 Load a config. file. and select accordingly.
or
Configure your local manually unit by selecting the appropriate keys
- 3 When a switch module is activated, 2 new lines in the **Acquisition** setup menu are available.

Figure 58 MPO Switch set up

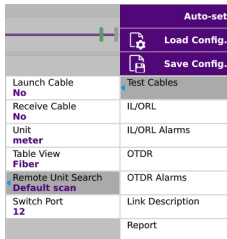

Auto-set	
	Load Config.
	Save Config.
	Test Cables
Launch Cable	No
Receive Cable	No
Unit	meter
Table View	Fiber
Remote Unit Search	Default scan
Switch Port	12
	Link Description
	Report

Test cables

- 1 Adjust the **Launch Cable / Receive cable** (if not done via the shortcuts)
- 2 Adjust the **Unit** accordingly
- 3 **Table view:** Fiber (recommended)
- 4 **Remote Unit Search :** **Default scan** (recommended)

Default scan: fast & optimized scan (adapted to all polarities type), (optimized connectivity search on the ports 3, 4, 9 and 10). For “Point to Point” links.



Full scan: longer but complete scan connectivity (scanning all 12 fibers, starting with port #1.). **Only for Point to Multipoint links** (12->1, ex. PON).



Configuring a measurement set up

Do not forget to configure the test set up before creating the project

Creating a project for an automatic switch sequence

To initiate an automatic switch sequence, a project must be created or opened. A project can be created with or without a label list:

- 1 Touch **Manage Project** in order to open or create a project.
Managing the test through a project will allow the switching sequence to run automatically.
- 2 Enter a **Project Name**.
A project directory will be created, and all measurement files will automatically be stored in this dedicated directory.

Figure 59 Project created

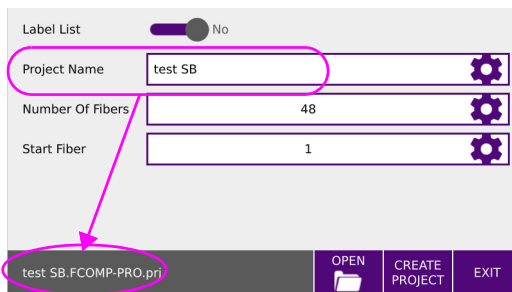

- 3 If the fibers do not have labels, just fill the project name, number of fibers and start fiber number.: see [Figure 59](#).
Or
If a Label list should be used, set “Label list” to **Yes** and browse by clicking on the “selected label list” section. There is an example .csv label list stored in the Project directory.

Figure 60 Project with Label

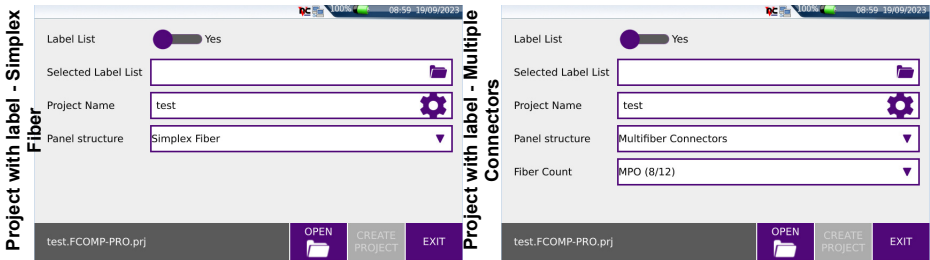

- 4 Fill the other requested information accordingly.
- 5 Press **Create Project**.
A new **Cable** tab will pop up displaying the Project with each fiber number or with the fiber labels.

Figure 61 Label Project - Simplex Fiber / Multifiber Connectors

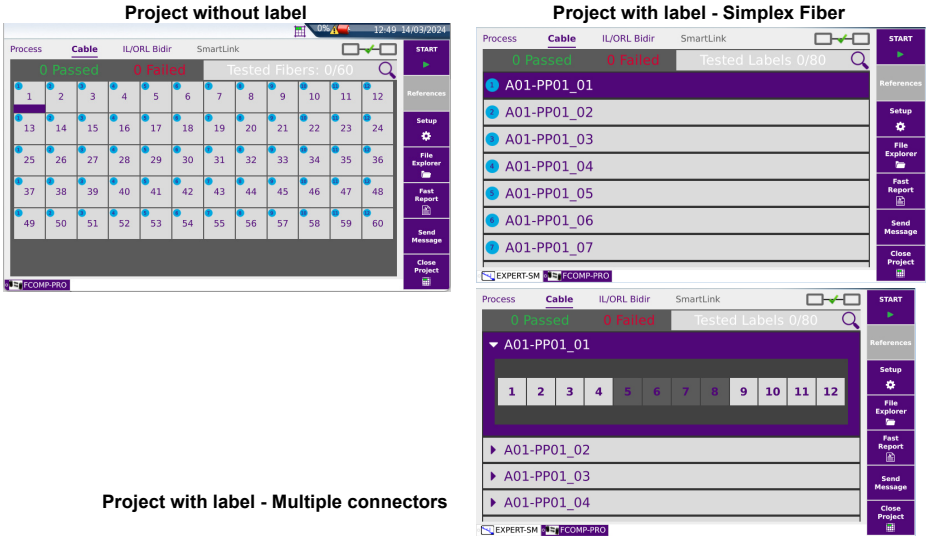

Project with label - Multiple connectors

The icon  displays on the upper banner.

Opening an existing project

- 1 In the Project setup page, press **Open**.
- 2 Select a project file (extension .prj) and press **Open Project**.
 The project displays in the Cable tab of the FCOMP_PRO page.

Figure 62 Opening an existing project

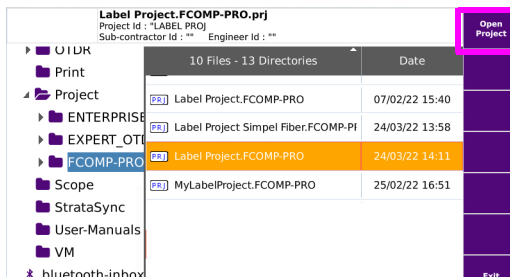

Customizing a test sequence

Project without label or with label for Simplex fiber

The Cable tab will display a « bingo » card with all squares pre-selected for the test sequence (Blue circle on top left of each square).

A selected fiber/label square is marked with purple at the bottom

- 1 Make a long press on any square of the bingo card to have access to a select menu.

After a long press on a fiber number, the following actions are available:

- **Disable Fiber** -> Disable the selected fiber.
- **Switch Seq. ON** -> Enable 12 fibers sequence starting @ selected fiber.
- **Cable Seq. OFF** -> Enable the bulk cable tests starting @ selected fiber.

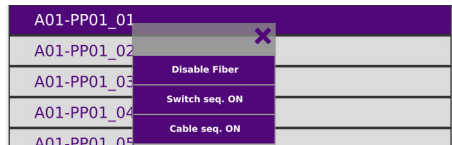

Project with label - Multiple connectors

With Multifiber connectors, you can unselect fibers one by one with a long press.

Figure 63 Disabled fiber

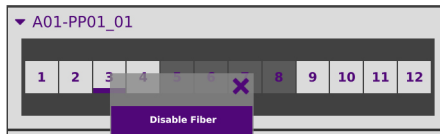

Make a long press on the disabled fiber to reset it as **Enabled fiber**.

Validating the end-to-end continuity and polarity

Before starting any test, we recommend to perform a continuity and polarity check:

- Continuity (no break, missing links or reverse connections) - for test Scenario 1 & 2 (see [Figure 12](#) and [Figure 13](#) on page 15).

- End to end polarity verification - for test scenario 2 (see Figure 13 on page 15).
- 1 Go to the **Process** tab.
 - 2 At the bottom of the screen, click on the button  .
 FCOMP-PRO tests the end-to-end continuity between the two instruments (for the 12 ports of the MPO switch), then identifies the most likely polarity and provides pass/fail indication.

Figure 64 Polarity types

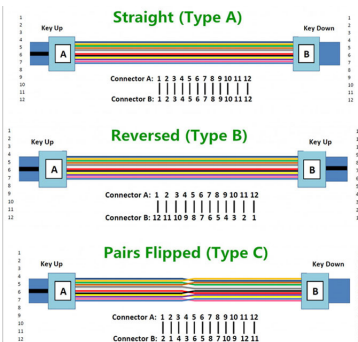

Figure 65 Polarity check

The screenshot shows the FCOMP-PRO software interface. A 'LOCAL' fiber port is connected to a 'REMOTE' fiber port. A 'Polarity Found:' button is highlighted, and a 'Report (R)' button is also highlighted. The interface shows 'Polarity: pass' and 'Polarity: fail' results with corresponding fiber port diagrams.

Polarity: pass

1	2	3	4	5	6	7	8	9	10	11	12
1	2	3	4	5	6	7	8	9	10	11	12

Polarity: fail

1	2	3	4	5	6	7	8	9	10	11	12
1	3	2	4	5	6	7	8	9	10	11	12

Polarity validation:

- Grey with crossing lines: link established with expected channels
- Red with crossing lines: link established with the non expected channel
- No crossing line: If no link is established

Launching the project test process

Once the project is open:

- 1 Press **START** – preferably from **Cable** tab to make sure of the fiber selection.
 Once complete, a message asks to test the next 12 fiber sequence



NOTE

The Setup and the Project are separated; at any time the setup can be modified for the opened Project.



NOTE

When a project is opened, the remote unit does not display the "transfer setting button."



CAUTION

If a test is launched for a fiber already tested, a dialog box displays: "Test #n already completed. Current results will be overwritten. Test again?".

Click on **Yes** to confirm the new test, thus, to delete existing file(s).

- 2 Once all wavelengths are measured, a popup asks:
- Click on **Yes** to test next fiber/label
 - Click on **No** to return to Cable tab/Project view.



If «Disable Fiber Test» is pressed while a tested fiber is selected, a dialog box displays: «You're about to delete acquisition files. Are you sure?».

Click on **Yes** to confirm the deactivation, and by consequence, to delete corresponding trace(s).

Click on **No** to cancel the action.

Stopping the test

The test stops automatically once the label/fiber test is completed; or the user can press **Stop** key at any time to stop the test in progress (not recommended).

In this case, the icon  is displayed on the label row to indicate that not all fibers have been tested.

Results display

In Cable tab

A summary is available on the top of the list indicating the numbers of: Passed / Failed / Tested fibers.

A test status is provided for each fiber with a color coding.

- Green = Passed / Red = Failed
- No color = no tests performed on the fiber or only partial tests performed in the sequence (ex. IL/ORL with Stop during OTDR) or no alarms set up
- Dark grey = unselected fiber

For Individual fiber results: select the fiber in the cable tab (the selected fiber will be highlighted in purple)



NOTE

To easily find a fiber, press the search glass icon (top right). It displays a filter to select fiber number or label number.

Bi-directional results : press **IL/ORL Bidir** tab for total link loss and ORL (total link loss & ORL are either acquired either from Continuous Wave or from the OTDR according to the test set up).

Press **Smartlink** for OTDR Averaging results (if TrueBIDIR selected in setup) or **OTDR unidir** (if uniDIR selected in setup).

OTDR traces: Browse in the file explorer to load the appropriate fiber trace.

Figure 66 Results for a Label project

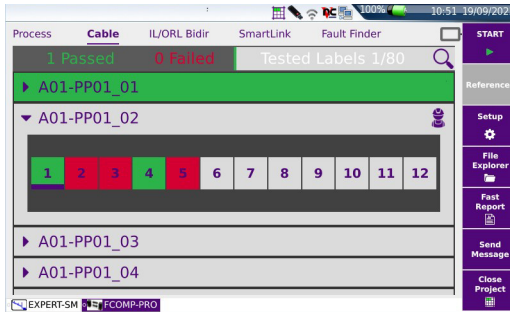

Expert OTDR - Trace tab

- The direction is indicated if « info » is selected.
- Clicking on the **Smartlink** or **Table** tabs give access to the other results representation.

Figure 67 OTDR Trace result

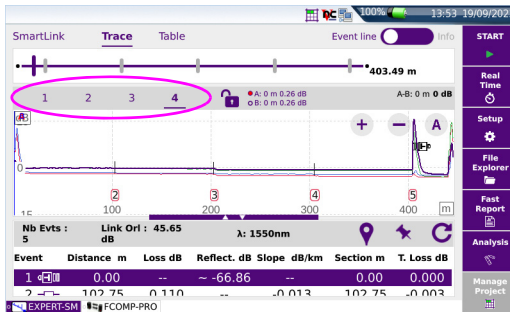

Search / Filter function

From the Label or SmartGrid project view, the list of label or fiber numbers displayed can be filtered to look for a specific group and avoid long-scrolling.:



- 1 Once project is displayed, click on Search tool 
- 2 Enter the label Id or the fiber number.
- 3 Press  to validate.
The project table is filtered according to search criteria.

Figure 68 Search/Filter function



Files and project storage

As soon as a project is created via CREATE PROJECT key (see "[Creating a project for an automatic switch sequence](#)" page 89), a folder, based on the Project ID/Name, is automatically generated with associated sub-directories.

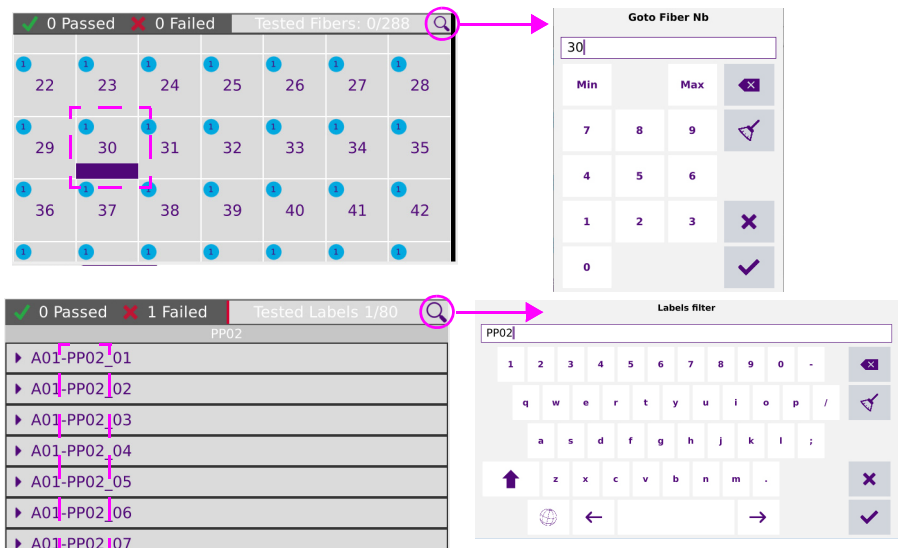
The project and all corresponding test files are saved in `disk/Project/FCOMP-PRO/[Project ID]/.`

Figure 69 Project files

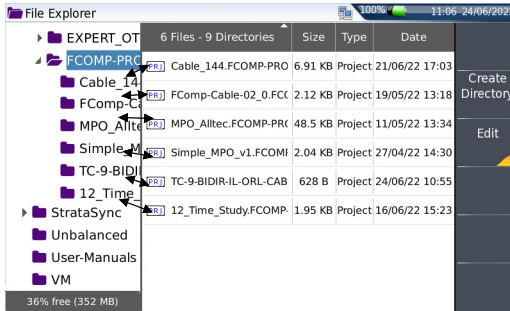

The project .prj file is not visible in the explorer until the project is closed.

For each project, a subdirectory with the project Id is created, containing test OTDR files and summary results (in text and pdf format).

As soon as the project is closed, a summary report is automatically generated and stored in the project directory.

Figure 70 Project directory structure with file contents

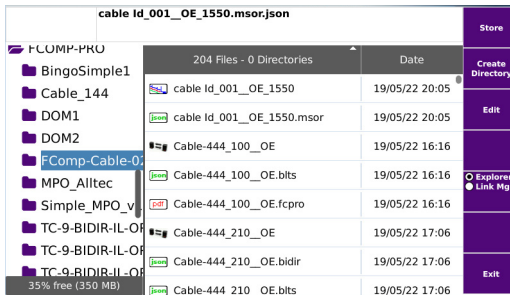

Explorer when a project is open

If a project is open, press **File** to go to the explorer: the explorer displays all the link information exclusively for the project measurement results.

An icon representing the alarm status is displayed for each measurement result (if alarm thresholds were defined).

Figure 71 Project open in Explorer

Fib #	Distance	L1310	L1550	L1625	O1310	O1550	O1625	Buttons
✓ 1	32.27	-	1.82	-	-	31.55	-	Create Directory
✗ 1	32.24	-	0.05	-	-	< 10.00	-	Edit
✓ 2	-112.20	-	2.01	-	-	47.17	-	
✗ 2	32.21	-	0.51	-	-	< 10.00	-	
✓ 3	-112.20	-	2.26	-	-	29.02	-	
✗ 3	32.22	-	0.35	-	-	< 10.00	-	
✓ 4	32.24	-	0.58	-	-	53.47	-	
✓ 4	32.24	-	0.58	-	-	53.47	-	Edit

Manual saving and report generation

Once a test is completed, the IL/ORL & OTDR results are automatically saved in a .fcpro file.



NOTE

- .sor file naming automatically includes: wavelength (1310, 1550, 1625...) and direction: OE for Origin-Extremity, or EO for Extremity-Origin

A txt / pdf report is also generated if the parameter **Report As** is defined, as well as .sor files if selected in the **Report** set up (see [page 33](#)).

Opening a report

- 1 To open the report, press **FILE** key
- 2 In the **File Explorer** page, in the directory selected, select the file of the report.
For the txt file:txt
For the pdf file:pdf
- 3 Press **Load**.
The file opens on the equipment.



CAUTION

To modify the VIAVI logo, set by default on the header of the pdf report, save your logo in a jpg file called `logo.jpg` and place it to the root of the disk:
`disk > logo.jpg`.



NOTE

A pdf report can also be generated from the File Explorer page onto the equipment (see user manual of the equipment).



700MAN203
Rev. 009, 03-24
English

VIAVI Solutions

North America: 1.844.GO VIAVI / 1.844.468.4284

Latin America +52 55 5543 6644

EMEA +49 7121 862273

APAC +1 512 201 6534

All Other Regions: [viavisolutions.com/contacts](https://www.viavisolutions.com/contacts)

email TAC@viavisolutions.com

address 6001 America Center Drive, San Jose, CA, 95002, USA